



TRIO
LIGHTING FOR YOU



TARSIA



Metall, Glas, Kunststoff
Metal, glass, plastic



SWITCH DIMMER

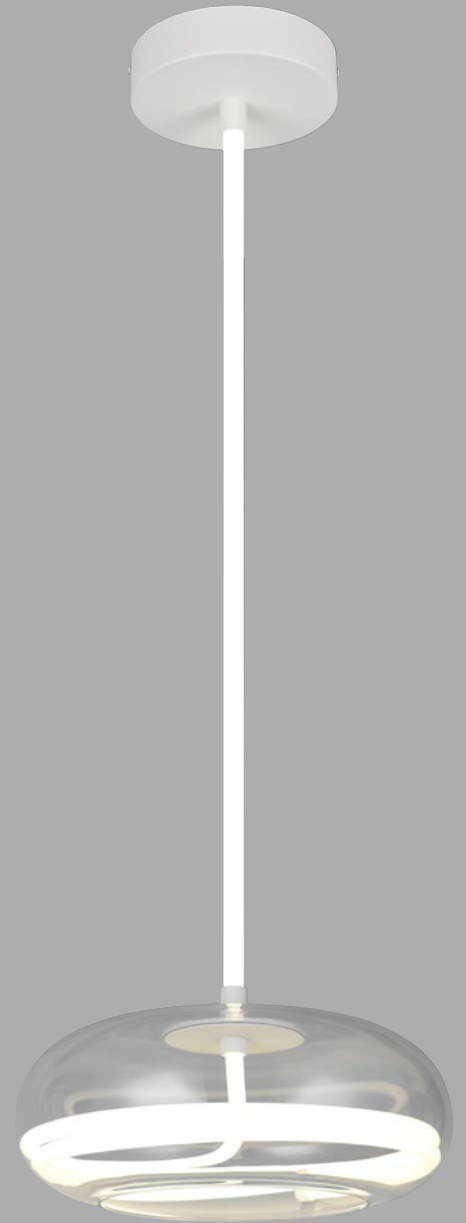

Wandleuchte · Wall lamp

incl. SMD-LED
11 W / 1.500 Lumen
4.000 Kelvin
237870131

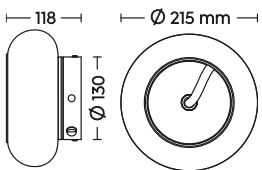

Deckenleuchte · Ceiling lamp

incl. SMD-LED
26 W / 3.500 Lumen
4.000 Kelvin
637810131

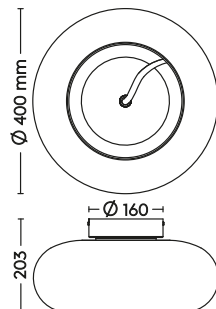

Pendelleuchte · Pendant

incl. SMD-LED
13 W / 1.700 Lumen
4.000 Kelvin
337810131

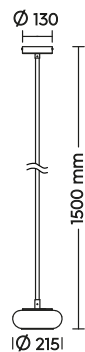

Pendelleuchte · Pendant

incl. SMD-LED
26 W / 3.500 Lumen
4.000 Kelvin
337819131

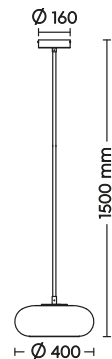



Pendelleuchte · Pendant
 incl. SMD-LED
 3 x 12 W / 3 x 1667 Lumen
 4.000 Kelvin
337810331

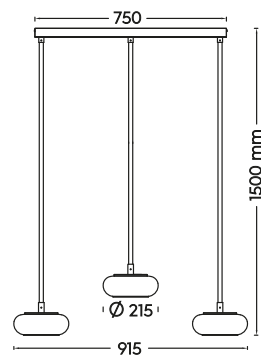

Pendelleuchte · Pendant
 incl. SMD-LED
 5 x 10 W / 5 x 1400 Lumen
 4.000 Kelvin
337810531

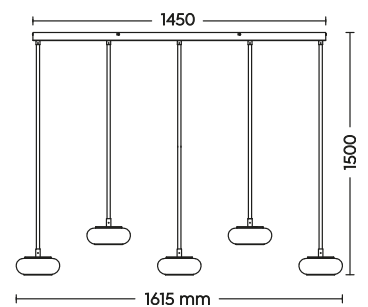

NAPOLI

Metall, Glas
Metal, glass



DIP SWITCH



SWITCH DIMMER



31 | Weiß matt · white mat



32 | Schwarz matt · black mat



Wandleuchte · Wall lamp
incl. SMD-LED
11 W / 1.200 Lumen
2.300 + 3.000 + 4.000 Kelvin
237970131
237970132

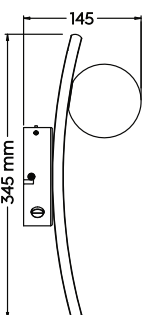

Pendelleuchte · Pendant
incl. SMD-LED
27 W / 3.200 Lumen
2.300 + 3.000 + 4.000 Kelvin
337910231
337910232

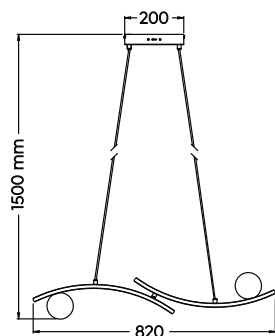

Deckenleuchte · Ceiling lamp
incl. SMD-LED
27 W / 3.200 Lumen
2.300 + 3.000 + 4.000 Kelvin
637910231
637910232

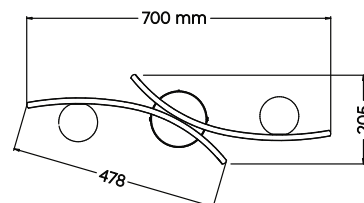



DIP SWITCH



SWITCH DIMMER

AROLA

Metall, Glas, Kunststoff
Metal, glass, plastic



31 | Weiß matt · white mat



32 | Schwarz matt · black mat

Wandleuchte · Wall lamp
incl. SMD-LED
11 W / 1.300 Lumen
2.300 + 3.000 + 4.000 Kelvin
238170131
238170132

Deckenleuchte · Ceiling lamp
incl. SMD-LED
22 W / 2.500 Lumen
2.300 + 3.000 + 4.000 Kelvin
638110131
638110132



IP20

IP20

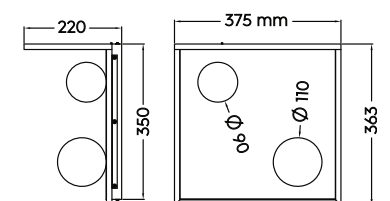
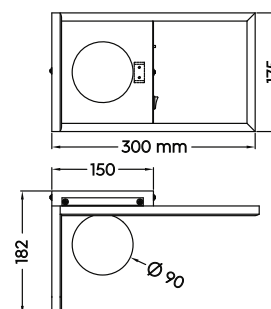

MONZA

Metall · metal

 Lichtfarbe einstellbar ·
Adjustable light color

 Sensordimmer ·
Sensor dimmer



 Memory Funktion ·
Memory function

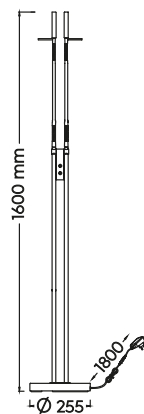
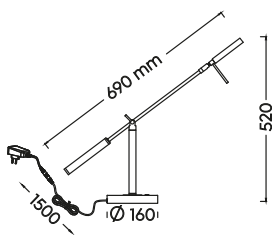

Tischleuchte · Table lamp
incl. SMD-LED
12 W / 1.400 Lumen
2.300 + 3.000 + 4.000 Kelvin
523310907
523310908
523310932

Stehleuchte · Floor lamp
incl. SMD-LED
2 x 12 W / 2 x 1.400 Lumen
2.300 + 3.000 + 4.000 Kelvin
423310207
423310208
423310232



-  **07** | Nickel matt · nickel mat
-  **08** | Messing matt · brass mat
-  **32** | Schwarz matt · black mat





Stehleuchte · Floor lamp
 incl. SMD-LED
 21W / 2.400 Lumen
 2.300 + 3.000 + 4.000 Kelvin
442410107
442410132
442410165



IP20

AMADOR

Metall · metal



Lichtfarbe einstellbar ·
 Adjustable light color



Integrierter Dimmer ·
 Integrated dimmer



Memory Funktion ·
 Memory function



07 | Nickel matt · nickel mat



32 | Schwarz matt · black mat



65 | Coffee · coffee

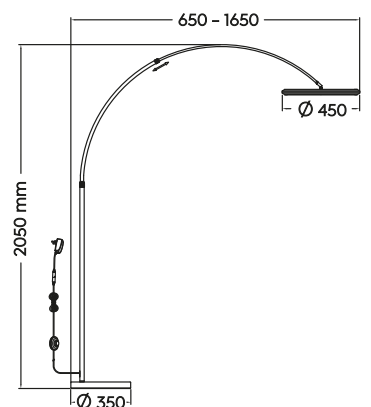







31



65



ZAYA

Metall, Acryl · metal, acryl

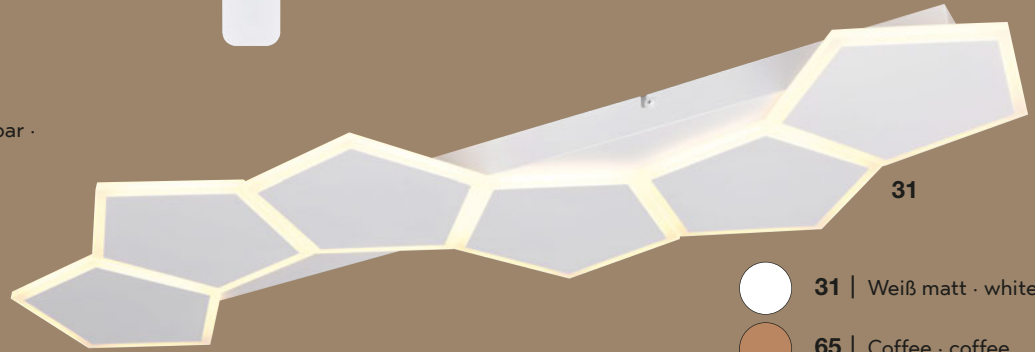
-  Lichtfarbe stufenlos einstellbar · Light color infinitely variable
-  SWITCH DIMMER
-  Memory Funktion · Memory function
-  Timer · Timer



31

-  31 | Weiß matt · white mat
-  65 | Coffee · coffee

Deckenleuchte · Ceiling lamp
incl. SMD-LED
34 W / 3.900 Lumen
2.700 - 6.500 Kelvin

636810631
636810665

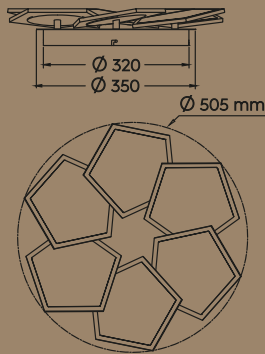

- 
- 
- 
- 
-  IP20

Deckenleuchte · Ceiling lamp
incl. SMD-LED
34 W / 3.900 Lumen
2.700 - 6.500 Kelvin

636819631
636819665

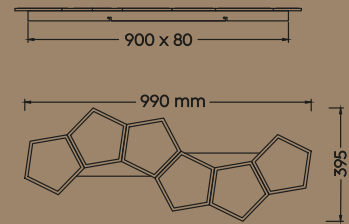

- 
- 
- 
- 
-  IP20

OVELA



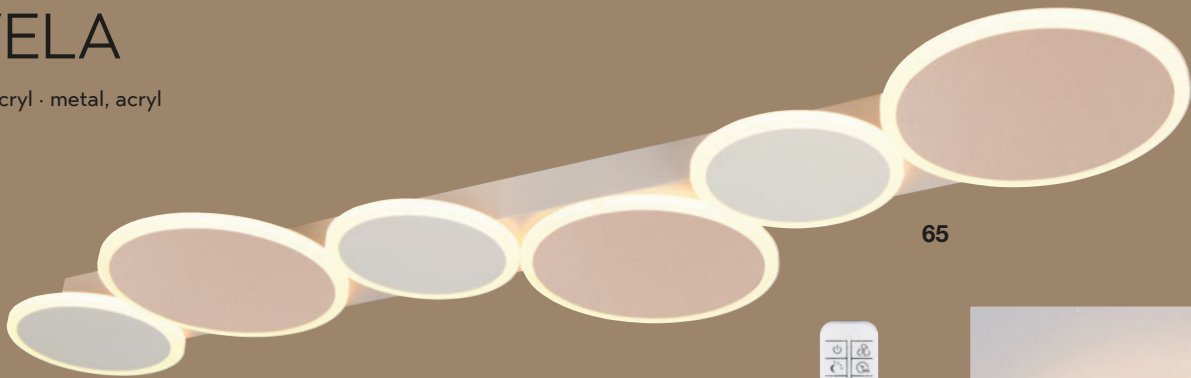

Metall, Acryl · metal, acryl



65





31

-  Lichtfarbe stufenlos einstellbar · Light color infinitely variable
-  SWITCH DIMMER
-  Memory Funktion · Memory function
-  Timer · Timer

Deckenleuchte · Ceiling lamp
incl. SMD-LED
34 W / 3.900 Lumen
2.700 - 6.500 Kelvin

636910631
636910665

- 
- 
- 
- 
-  IP20

-  31 | Weiß matt · white mat
-  65 | Coffee · coffee

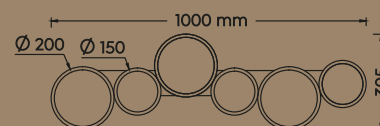







RIVA

Metall Weiß matt, Acryl
Metal white mat, acryl

-  Lichtfarbe stufenlos einstellbar ·
Light color infinitely variable
-  SWITCH DIMMER
-  Memory Funktion ·
Memory function



Deckenleuchte · Ceiling lamp
incl. SMD-LED
14 W / 1.500 Lumen
2.700 - 6.500 Kelvin
636714131

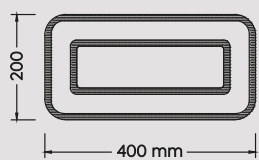

Deckenleuchte · Ceiling lamp
incl. SMD-LED
20 W / 2.300 Lumen
2.700 - 6.500 Kelvin
636716131



Deckenleuchte · Ceiling lamp
incl. SMD-LED
35 W / 4.100 Lumen
2.700 - 6.500 Kelvin
636719131

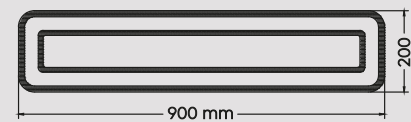





Wandleuchte · Wall lamp
incl. SMD-LED
7 W / 800 Lumen
2.300 + 3.000 + 4.000 Kelvin
238270132

Wandleuchte · Wall lamp
incl. SMD-LED
8,5 W / 1.000 Lumen
2.300 + 3.000 + 4.000 Kelvin
238270332

ARPINO

Metall, Schwarz matt
Metal, black mat

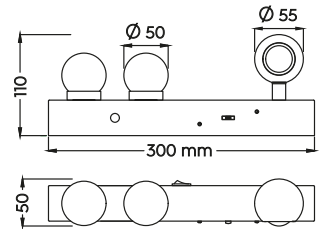
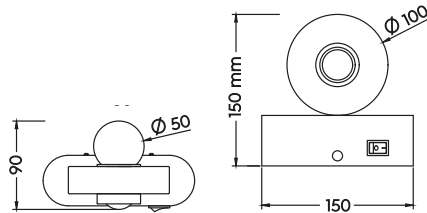
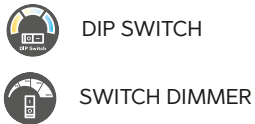

PRATELLA

Kunststoff · plastic



MIO

Metall · metal



Individuell verstellbar
Individually adjustable

32 | Schwarz matt · black mat
43 | Warm Beige · warm fawn

Wandleuchte · Wall lamp
excl. 1 x E27
max. 10 W
269370131
269370132

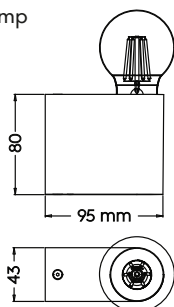

31 | Weiß matt · white mat
32 | Schwarz matt · black mat

Wandleuchte · Wall lamp
incl. SMD-LED
6 W / 560 Lumen
3.000 Kelvin
240319132
240319143

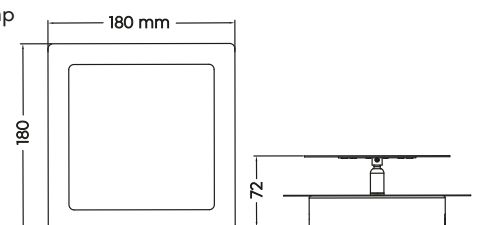



360° drehbar für direktes oder indirektes Licht
 360° Adjustable for direct or indirect light

CASSINO

Metall · metal



DIP SWITCH



SWITCH DIMMER



31 | Weiß matt · white mat



32 | Schwarz matt · black mat

Wandleuchte · Wall lamp
 incl. SMD-LED
 14 W / 1.700 Lumen
 2.300 + 3.000 + 4.000 Kelvin
237770131
237770132

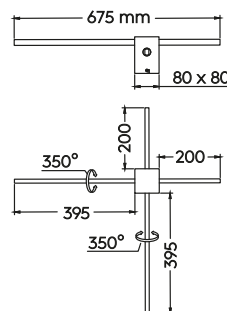

Wandleuchte · Wall lamp
 incl. SMD-LED
 7 W / 850 Lumen
 2.300 + 3.000 + 4.000 Kelvin
237779131
237779132

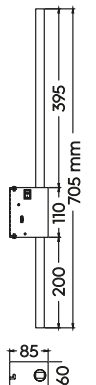

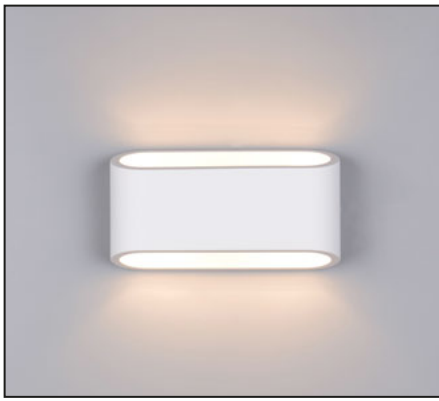

SEPANTA

Wandleuchte · Wall lamp

excl. 2 x G9
max. 5 W

201103201



Empfohlen:
recommended:

LED G9
3 W / 300 Lumen
3.000 Kelvin
929-2300

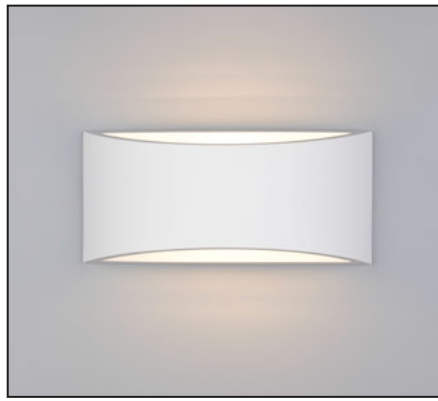
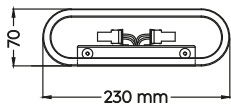
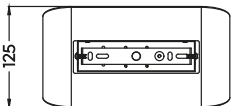

WACADIA

Wandleuchte · Wall lamp

excl. 1 x E14
max. 10 W

201101101



Empfohlen:
recommended:

Filament LED E14
4 W / 470 Lumen
2.700 Kelvin
983-400

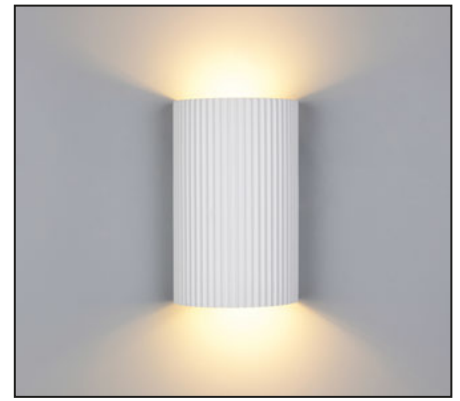
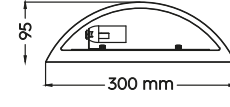

RAPOSA

Wandleuchte · Wall lamp

excl. 2 x GU10
max. 5 W

201105201



Empfohlen:
recommended:

LED GU10
4,5 W / 345 Lumen
3.000 Kelvin
956-5936

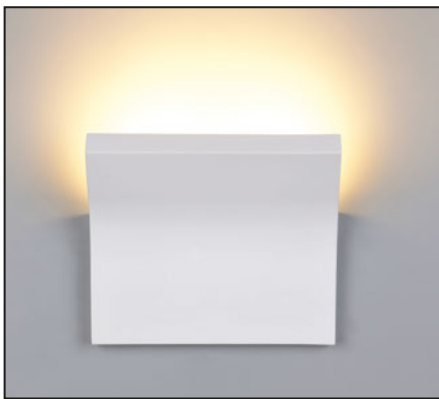
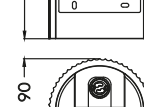
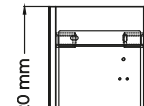

VANJURA

Wandleuchte · Wall lamp

excl. 2 x GX53
max. 10 W

201106101



Empfohlen:
recommended:

LED GX53
10 W / 950 Lumen
4.000 Kelvin
953-1334

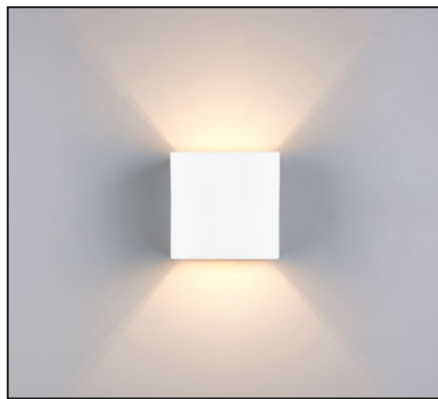
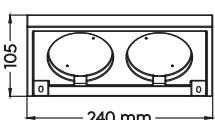
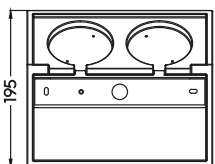

DADI

Wandleuchte · Wall lamp

excl. 1 x G9
max. 5 W

201102101



Empfohlen:
recommended:

LED G9
3 W / 300 Lumen
3.000 Kelvin
929-2300

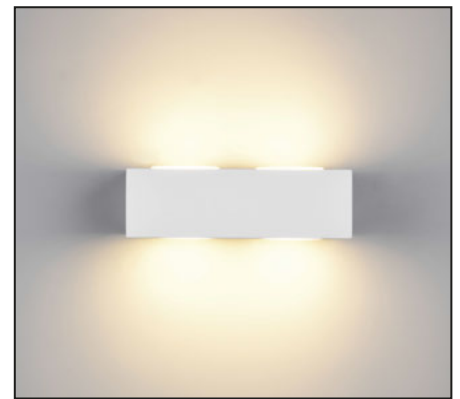
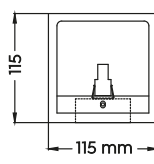
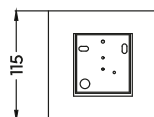

MATTONE

Wandleuchte · Wall lamp

excl. 4 x GX53
max. 10 W

201104401



Empfohlen:
recommended:

LED GX53
10 W / 950 Lumen
4.000 Kelvin
953-1334

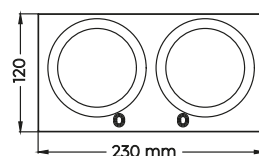
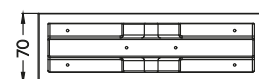



Überstreichbare Gipsleuchten
für individuelle Looks

Paintable plaster lights
for individual looks

Dank ihrer überstreichbaren Oberfläche lassen sich diese Wandleuchten individuell an Wandfarbe oder Raumgestaltung anpassen.

Thanks to their paintable surface, these wall lights can be individually adapted to the wall colour or room design.





Pendelleuchte · Pendant
 incl. SMD-LED
 3 x 5 W / 3 x 800 Lumen
 R33553306 4.000 Kelvin
 R33553342 3.000 Kelvin

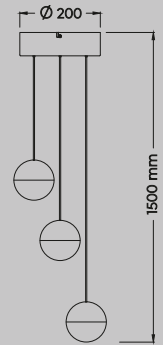

Pendelleuchte · Pendant
 incl. SMD-LED
 3 x 5 W / 3 x 800 Lumen
 R33553106 4.000 Kelvin
 R33553142 3.000 Kelvin

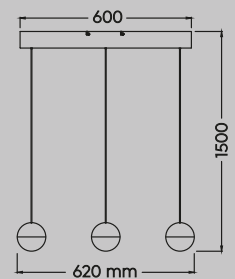

MANSA

Metall · metal

 **31** | Weiß matt · white mat

 **32** | Schwarz matt · black mat

Pendelleuchte · Pendant
 incl. SMD-LED
 36 W / 4.200 Lumen
 R33111131 4.000 Kelvin
 R33111132 3.000 Kelvin

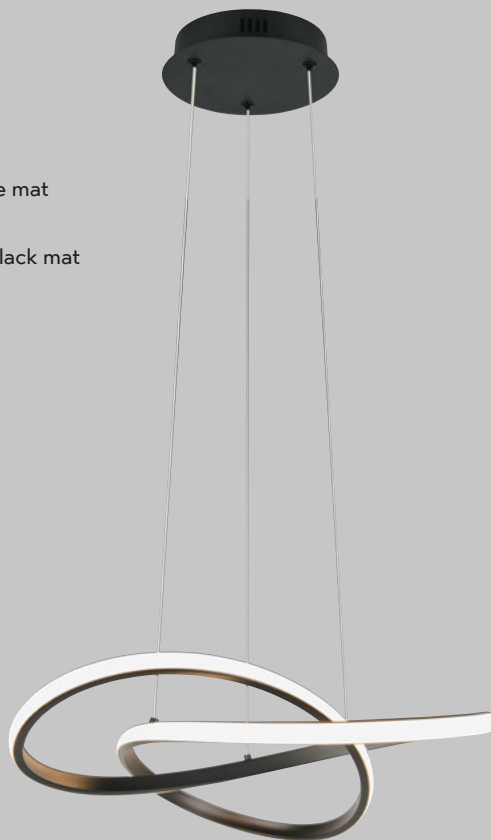
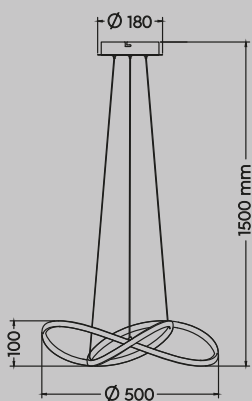



SENTA

Metall, Acryl · metal, acryl

 **06** | Chrom · chrome

 **42** | Anthrazit · anthracite

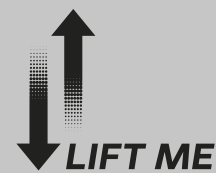

Innovative
Höhenverstellung
ohne Gegengewicht.
Innovative height
adjustment without
counterweight.

Pendelleuchte · Pendant

incl. SMD-LED
5 x 5 W / 5 x 800 Lumen

R33555106 4.000 Kelvin

R33555142 3.000 Kelvin

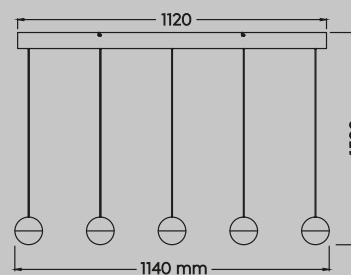

Pendelleuchte · Pendant

incl. SMD-LED
5 W / 800 Lumen

R33551106 4.000 Kelvin

R33551142 3.000 Kelvin

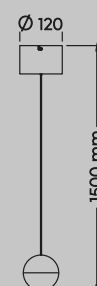

PARDINA

Metall Schwarz matt, Stoffschirm
Metal black mat, fabric shade



Deckenleuchte · Ceiling lamp

excl. 2 x E14
max. 40 W

R66742032

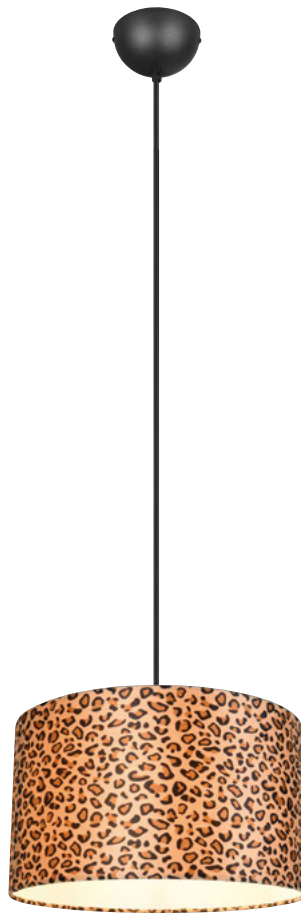
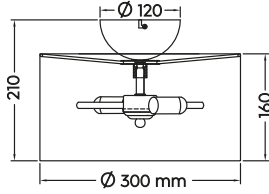

Tischleuchte · Table lamp

excl. 1 x E14
max. 10 W

R56741032

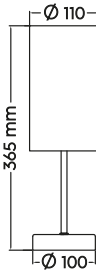

Pendelleuchte · Pendant

excl. 1 x E27
max. 40 W

R36741032

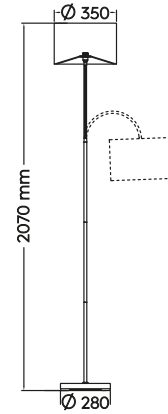
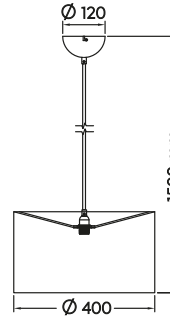

Stehleuchte · Floor lamp

excl. 1 x E27
max. 40 W

R46741032



ZEBARA

Metall Schwarz matt, Stoffschirm
Metal black mat, fabric shade

Tischleuchte · Table lamp

excl. 1 x E14
max. 10 W

R56751032

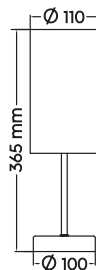







ELUNA

Metall, Glas · metal, glass

 **04** | Altmessing · old brass

 **32** | Schwarz matt · black mat

Pendelleuchte · Pendant

excl. 1 x E27
max. 40 W

R36521004

R36521032

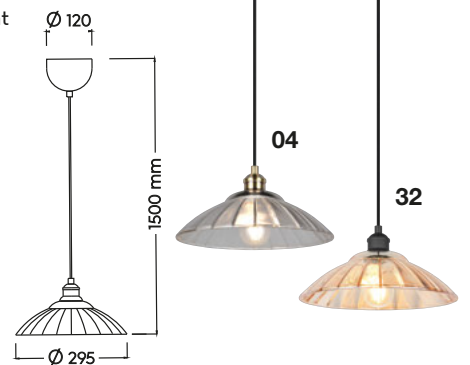

Pendelleuchte · Pendant

excl. 3 x E27
max. 40 W

R36523004

R36523032

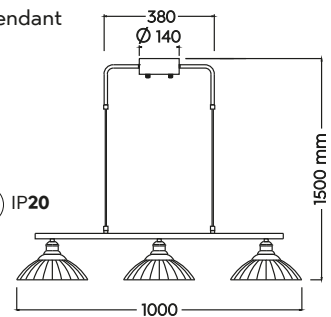

ABELLA

Metall, Glas · metal, glass





Pendelleuchte · Pendant

excl. 1 x E27
max. 10 W

R36761013

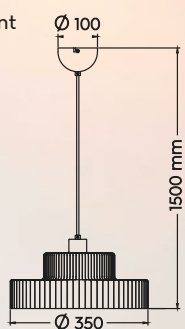
R36761052



 **13** | Amber · amber

 **52** | Transparent klar · transparent clear

ELVEZIA

Metall, Glas · metal, glass

Pendelleuchte · Pendant

excl. 1 x E27
max. 10 W

R36771013

R36771052

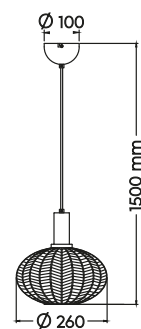
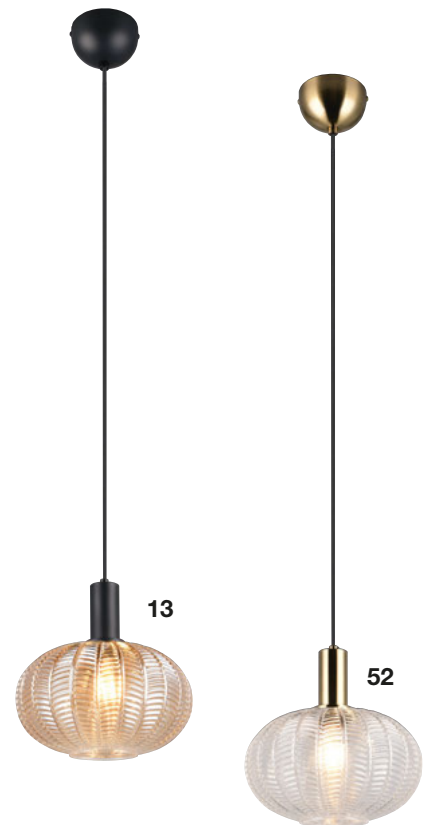

 **13** | Amber · amber

 **52** | Transparent klar · transparent clear

SIDERA

Metall, Glas · metal, glass

- 01** | Weiß · white ·
Glas Opal Weiß · glass opal white
- 13** | Amber · amber ·
Glas Amber · glass amber



01



13

Deckenleuchte · Ceiling lamp

excl. 1 x E27
max. 40 W

R66831001
R66831013

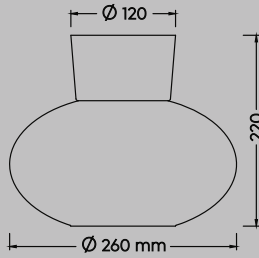

SIGNE

Metall · metal

- 01** | Weiß · white



Pendelleuchte · Pendant

excl. 1 x E14
max. 10 W

R36861001

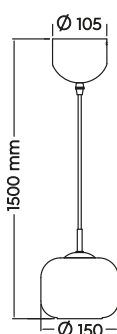

Pendelleuchte · Pendant

excl. 1 x E27
max. 10 W

R36861901

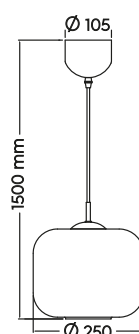

LIORA

Metall, Glas · metal, glass

- 13** | Amber · amber
- 54** | rauchfarbig · smoke

Pendelleuchte · Pendant

excl. 1 x E27
max. 15 W

R36601013
R36601054



LIFT ME

Innovative
Höhenverstellung
ohne Gegengewicht.
Innovative height
adjustment without
counterweight.

13

54

TOVA

Metall · metal

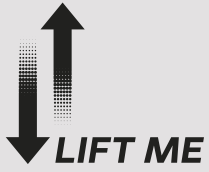

Innovative
Höhenverstellung
ohne Gegengewicht.
Innovative height
adjustment without
counterweight.

Pendelleuchte · Pendant

excl. 1 x E27
max. 15 W

R36411032
R36411076



● 32 | Schwarz matt · black mat
○ 76 | Warm Grau · warm grey

AMARILA

Metall · metal

● 32 | Schwarz matt · black mat
● 65 | Coffee · coffee



Pendelleuchte · Pendant

excl. 1 x E27
max. 40 W

R36841032
R36841065

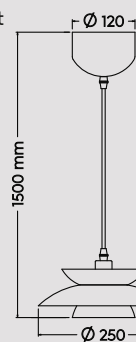

Pendelleuchte · Pendant

excl. 1 x E27
max. 40 W

R36841932
R36841965

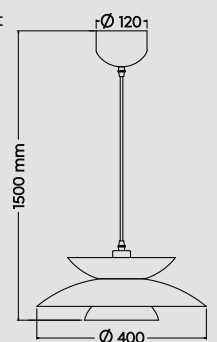

TILOS

Metall · metal

Pendelleuchte · Pendant

excl. 1 x E27
max. 10 W

R36501042
R36501043

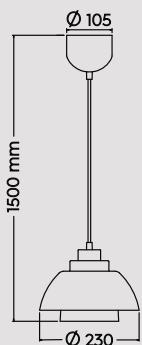

● 42 | Anthrazit · anthracite

● 43 | Warm Beige · warm fawn



Pendelleuchte · Pendant

excl. 1 x E27
max. 10 W

R36501942
R36501943

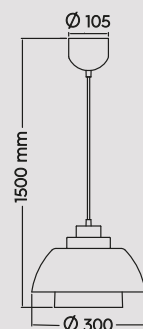





ZARO

Metall Schwarz matt, Holznachbildung
 Metal black mat, wood imitation

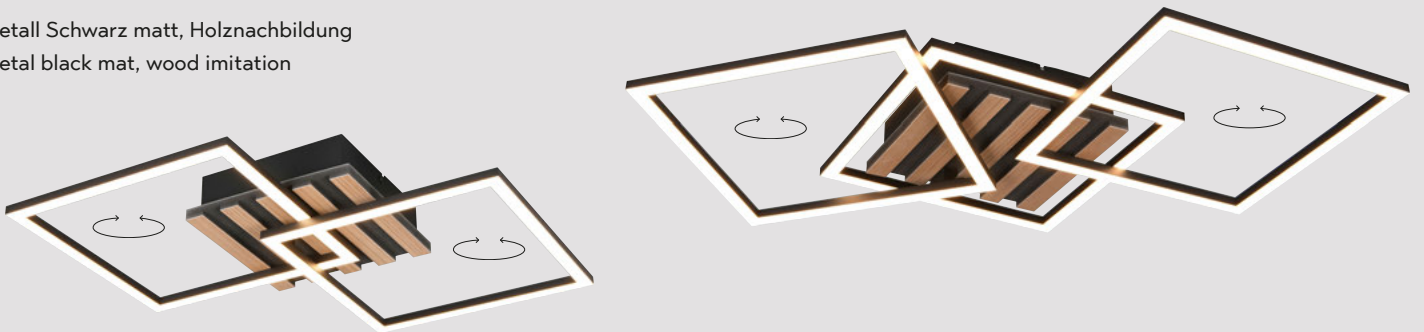

Deckenleuchte · Ceiling lamp
 incl. SMD-LED
 20 W / 2.250 Lumen
 3.000 Kelvin
R63402132

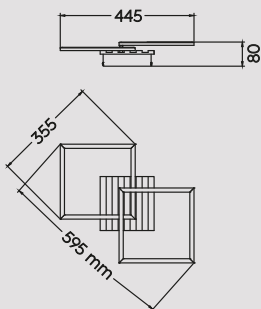

Deckenleuchte · Ceiling lamp
 incl. SMD-LED
 30 W / 3.550 Lumen
 3.000 Kelvin
R63403132

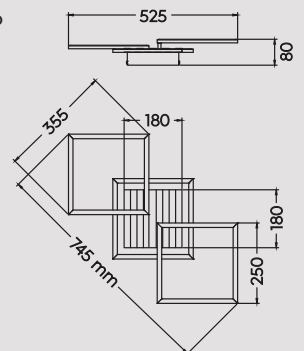



VONO

Metall Schwarz matt, Glas
Metal black mat, glass

 Lichtfarbe stufenlos einstellbar ·
Light color infinitely variable

 RGB Farbwechsler ·
RGB Colorchanging



Deckenleuchte · Ceiling lamp
incl. SMD-LED
17 W / 1.900 Lumen
2.700 - 6.500 Kelvin
incl. RGB-LED
3 W / 360 Lumen
R63441032

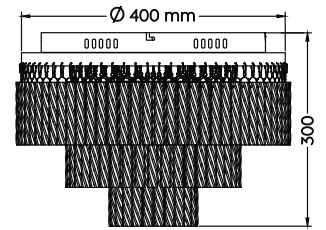

MOVA

Metall chrom, Acryl
Metal chrome, glass

Deckenleuchte · Ceiling lamp
incl. SMD-LED
22 W / 3.000 Lumen
4.000 Kelvin
R63292106

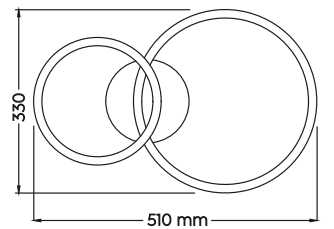

Deckenleuchte · Ceiling lamp
incl. SMD-LED
32 W / 4.200 Lumen
4.000 Kelvin
R63293106

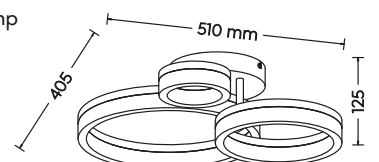

UMBRIA

Kunststoff Weiß · Plastic white



UMBRIA V
Deckenleuchte · Ceiling lamp
incl. SMD-LED
16 W / 1.600 Lumen
4.000 Kelvin
R64635101

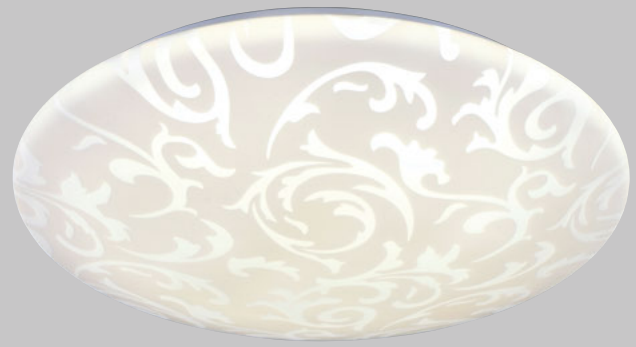
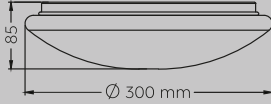

UMBRIA V
Deckenleuchte · Ceiling lamp
incl. SMD-LED
24 W / 2.500 Lumen
4.000 Kelvin
R64635901

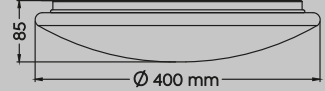

UMBRIA VI
Deckenleuchte · Ceiling lamp
incl. SMD-LED
16 W / 1.600 Lumen
4.000 Kelvin
R64636101

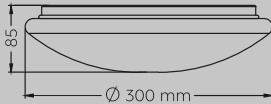

UMBRIA VI
Deckenleuchte · Ceiling lamp
incl. SMD-LED
24 W / 2.500 Lumen
4.000 Kelvin
R64636901

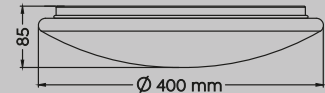

MANDRIA

Kunststoff Weiß
Plastic white



MANDRIA II
Deckenleuchte · Ceiling lamp
incl. SMD-LED
16 W / 1.600 Lumen
4.000 Kelvin
R64661901

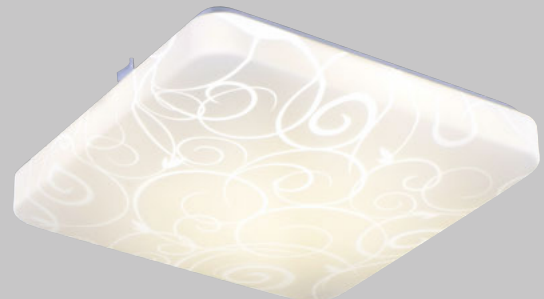
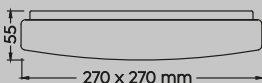



MANDRIA IV
Deckenleuchte · Ceiling lamp
incl. SMD-LED
16 W / 1.600 Lumen
4.000 Kelvin
R64664101





SANO

Metall Schwarz, Kunststoff Weiß
Metal black, plastic white

-  Lichtfarbe stufenlos einstellbar · Light color infinitely variable
-  Integrierter Dimmer · Integrated dimmer
-  Memory Funktion · Memory function



Deckenleuchte · Ceiling lamp



incl. SMD-LED
23 W / 2.400 Lumen
2.700 - 6.500 Kelvin

R63481001



ROTUNDA

Kunststoff Weiß
Plastic white

-  Lichtfarbe stufenlos einstellbar · Light color infinitely variable
-  SWITCH DIMMER
-  Memory Funktion · Memory function



Deckenleuchte · Ceiling lamp

incl. SMD-LED
24 W / 2.500 Lumen
2.700 - 6.500 Kelvin

R63071101

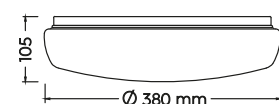



Strahler · Spot
 excl. 2 x GU10
 max. 5 W
R86852031
R86852032
R86852065

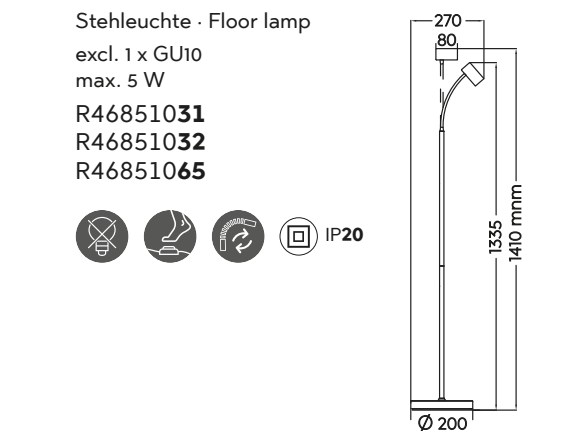
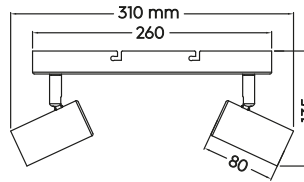

Stehleuchte · Floor lamp
 excl. 1 x GU10
 max. 5 W
R46851031
R46851032
R46851065

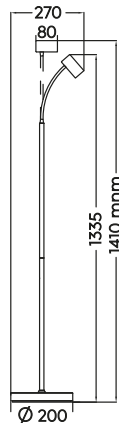

Strahler · Spot
 excl. 3 x GU10
 max. 5 W
R86853031
R86853032
R86853065

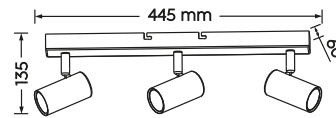

Tischleuchte · Table lamp
 excl. 1 x GU10
 max. 5 W
R56851031
R56851032
R56851065

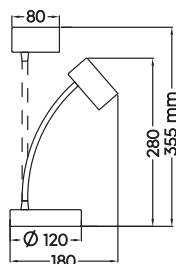

Strahler · Spot
 excl. 4 x GU10
 max. 5 W
R86854031
R86854032
R86854065

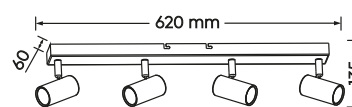



Strahler · Spot

excl. 1 x GU10
max. 5 W

R86851731
R86851732
R86851765

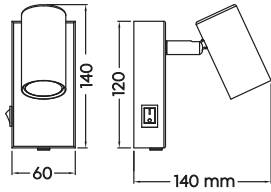

Wandleuchte · Wall lamp

excl. 1 x GU10
max. 5 W

R26851731
R26851732
R26851765

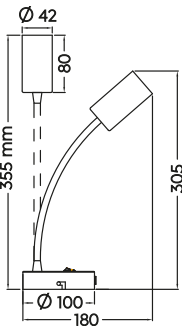

Wandleuchte · Wall lamp

excl. 2 x GU10
max. 5 W

R26852731
R26852732
R26852765

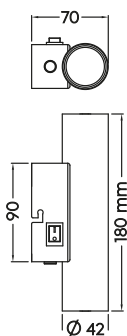

TARYN

Metall · metal

- 31 | Weiß matt · white mat
- 32 | Schwarz matt · black mat
- 65 | Coffee · coffee



Empfohlen:
recommended:



LED Mini-GU10
4 W / 345 Lumen
2.700 Kelvin
954-1432



LED Mini-GU10
4 W / 345 Lumen
3.000 Kelvin
954-1123



LED Mini-GU10
4 W / 450 Lumen
4.000 Kelvin
954-1534



MARS

Metall Schwarz matt, Glas rauchfarbig
metal black mat, glass smoke

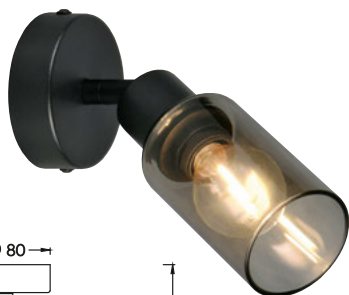

Strahler · Spot
excl. 1 x E14
max. 28 W
R80011032

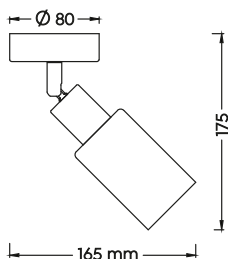

Strahler · Spot
excl. 2 x E14
max. 28 W
R80012032

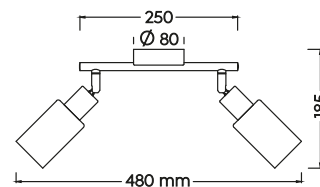

Strahler · Spot
excl. 4 x E14
max. 28 W
R80013932

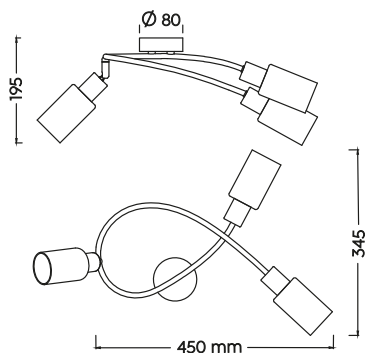

Strahler · Spot
excl. 4 x E14
max. 28 W
R80014032

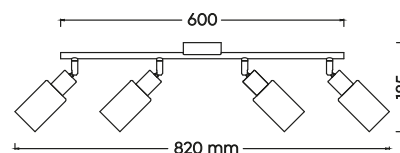



TRAVIA

Metall Schwarz matt, Holz, Glas rauchfarbig
metal black mat, wood, glass smoke



Strahler · Spot
excl. 1 x E14
max. 28 W
R86531732

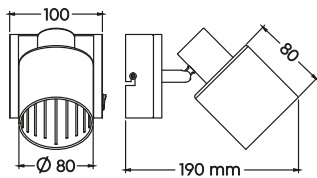

Strahler · Spot
excl. 2 x E14
max. 28 W
R86532032

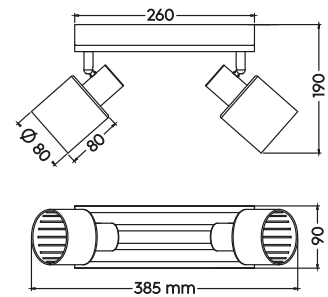

Strahler · Spot
excl. 3 x E14
max. 28 W
R86533032

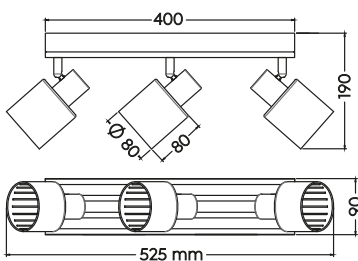

Strahler · Spot
excl. 4 x E14
max. 28 W
R86534032

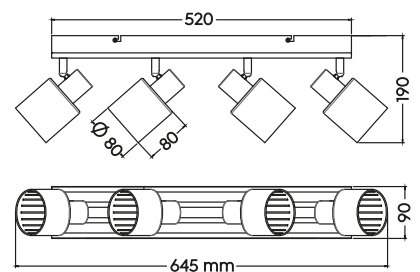

HUMA

Keramik, Stoffschirm
ceramic, fabric shade

- 01** | Weiß · white
- 02** | Schwarz · black

- 12** | Blau · blue
- 91** | Lila · lilac



Tischleuchte · Table lamp

excl. 1 x E14
max. 10 W

R56531001
R56531002
R56531012
R56531091

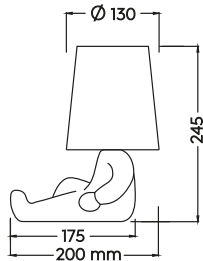

QUINN

Keramik, Glas Weiß
ceramic, glass white

- 02** | Schwarz · black
- 15** | Grün · green

- 40** | Apricot · apricot
- 76** | Warm Grau
warm grey



Tischleuchte · Table lamp

excl. 1 x G9
max. 5 W

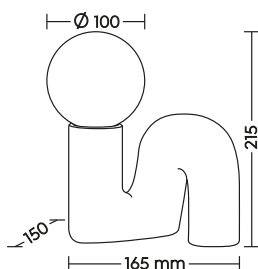

R56821002
R56821015
R56821040
R56821076





GATIO

Polyresin, Glas Weiß
Polyresin, glass white

-  **02** | Schwarz · black
-  **79** | goldfarbig · gold



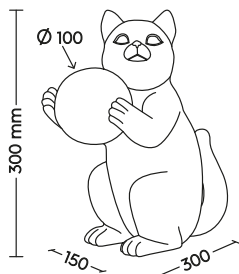

79

Tischleuchte · Table lamp
excl. 1 x G9
max. 5 W
R56621002
R56621079



CAPI

Polyresin, Glas Weiß
Polyresin, glass white

-  **02** | Schwarz · black
-  **79** | goldfarbig · gold



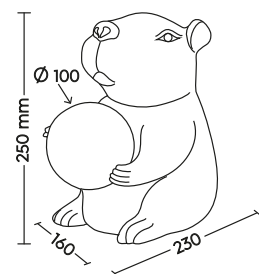

02

Tischleuchte · Table lamp
excl. 1 x G9
max. 5 W
R56721002
R56721079



LOVA

Keramik, Kunststoff Weiß
Ceramic, plastic white

-  **79** | goldfarbig · gold
-  **89** | silberfarbig · silver



79



89

Tischleuchte · Table lamp
excl. 1 x E27
max. 10 W
R56541079
R56541089

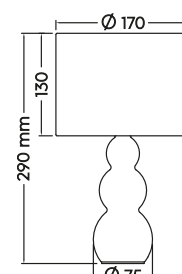



CIRRUS

Kunststoff Schwarz matt
Plastic black mat



RGB Farbwechsler ·
RGB Colorchanging



USB-C Anschluss ·
USB-C connection



Geeignet für Batteriebetrieb ·
Suitable for use with batteries



Tischleuchte · Table lamp
incl. SMD-LED 0,4 W
R53491132



IP20

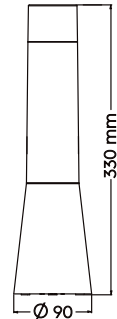

MARTINI

Kunststoff Schwarz matt
Plastic black mat



RGB Farbwechsler ·
RGB Colorchanging



USB-C Anschluss ·
USB-C connection



Geeignet für Batteriebetrieb ·
Suitable for use with batteries

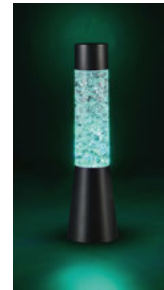

Tischleuchte · Table lamp
incl. SMD-LED 0,4 W
R53521132



IP20

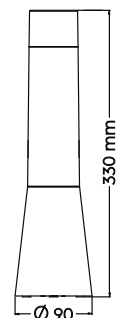

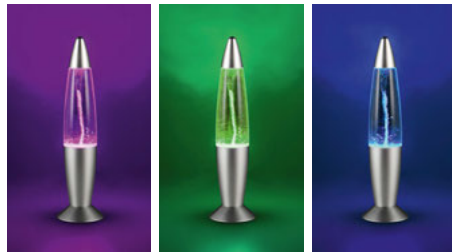

APOLLO

Kunststoff chromfarbig
Plastic chrome

 RGB Farbwechsler ·
RGB Colorchanging

 USB Anschluss ·
USB connection

Tischleuchte · Table lamp
incl. SMD-LED 0,4 W
R53571187

  IP20

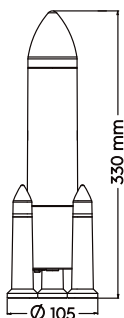

HOLLY

Kunststoff titanfarbig · Plastic titan

 RGB Farbwechsler ·
RGB Colorchanging

 USB-C Anschluss ·
USB-C connection

 Geeignet für Batteriebetrieb ·
Suitable for use with batteries

Tischleuchte · Table lamp
incl. SMD-LED 0,4 W
R53641187

  IP20

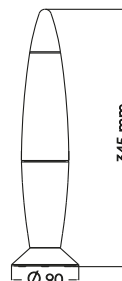

FAME

Kunststoff titanfarbig · Plastic titan

 RGB Farbwechsler ·
RGB Colorchanging

 USB-C Anschluss ·
USB-C connection

 Geeignet für Batteriebetrieb ·
Suitable for use with batteries

Tischleuchte · Table lamp
incl. SMD-LED 0,4 W
R53651187

  IP20

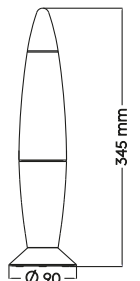

LUMA

Polyresin Braun · Polyresin brown





 RGB Farbwechsler · RGB Colorchanging

 USB-C Anschluss · USB-C connection

Tischleuchte · Table lamp
incl. SMD-LED 0,3 W
R59711126

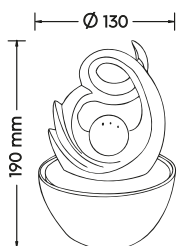
 IP20



 USB-C Anschluss · USB-C connection

Tischleuchte · Table lamp
incl. SMD-LED 0,06 W
R59711926

 IP20

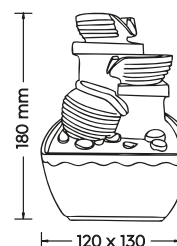

PASHA

Kunststoff · Plastic

 RGB Farbwechsler · RGB Colorchanging

Leuchtmittel · Light sources
SMD-LED 3 W, E27
R908-1471

 IP20

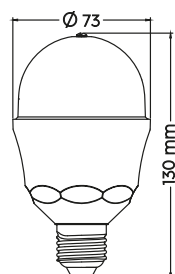

TRESOR

Kunststoff · Plastic

 RGB Farbwechsler · RGB Colorchanging

Leuchtmittel · Light sources
SMD-LED 2,5 W, E27
R987-1471

 IP20

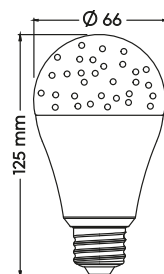



SHELLY

Kunststoff Pink · Plastic pink



RGB Farbwechsler ·
RGB Colorchanging



USB Anschluss ·
USB connection



Geeignet für Batteriebetrieb ·
Suitable for use with batteries

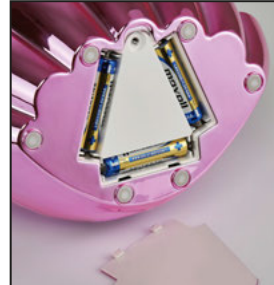

Tischleuchte · Table lamp

incl. SMD-LED
0,8 W / 15 Lumen
R57731193

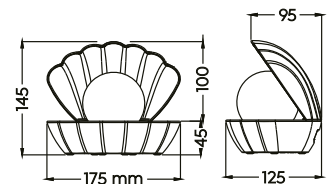

IP20



STAVRO

Metall goldfarbig, Glas
Metal gold, glass



4 fach TOUCH ·
4 level Touch function



USB-C Anschluss ·
USB-C connection



Akkubetrieb ·
Rechargeable battery operated



Tischleuchte · Table lamp

incl. SMD-LED
5 W / 140 Lumen
3.000 Kelvin
R53121117

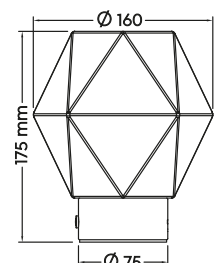

IP20







Pendelleuchte · Pendant

excl. 1 x E27
max. 10 W

R36791032

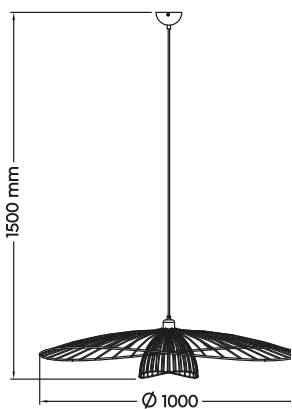

Deckenleuchte · Ceiling lamp

excl. 1 x E27
max. 10 W

R66791032

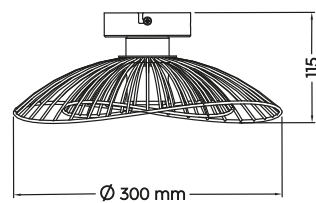

Stehleuchte · Floor lamp

excl. 1 x E27
max. 10 W

R46791032

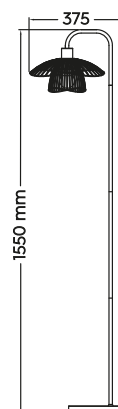



LAURIS

Metall Schwarz matt, goldfarbig
Metal black mat, gold



Tischleuchte · Table lamp
excl. 1 x E27
max. 10 W
R56791032

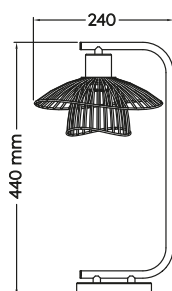

Pendelleuchte · Pendant
excl. 1 x E27
max. 10 W
R36791932

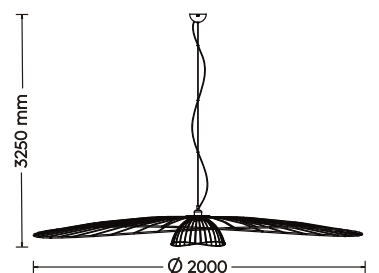



YAKO

Metall Schwarz matt
Metal black mat

Strahler · Spot
excl. 1 x E14
max. 40 W
R86701032

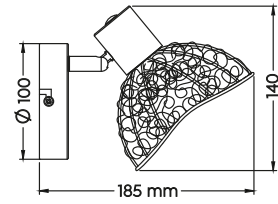

Strahler · Spot
excl. 2 x E14
max. 40 W
R86702032

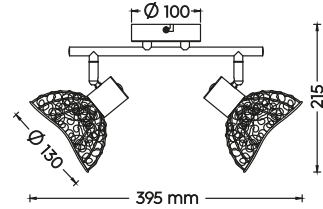

SAMDEL

Metall Schwarz matt, goldfarbig
Metal black mat, gold



Empfohlen:
recommended:

LED G9
3 W / 300 Lumen
3.000 Kelvin
929-2300



Wandleuchte · Wall lamp
excl. 1 x G9
max. 5 W
R26721080

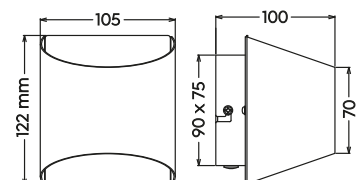



JEROME

Metall Schwarz matt,
Rattangeflecht naturbelassen
Metal black mat
rattan meshwork natural finish

Strahler · Spot
excl. 1 x E27
max. 10 W
R86231732

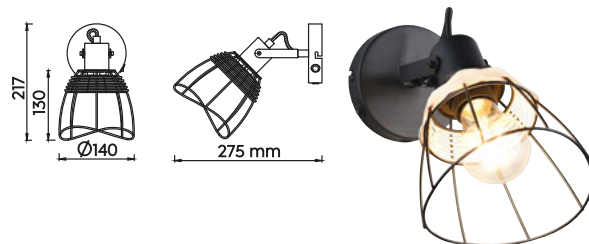

Strahler · Spot
excl. 3 x E27
max. 10 W
R86233032

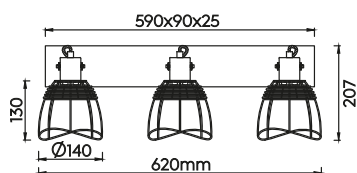

Strahler · Spot
excl. 2 x E27
max. 10 W
R86232032

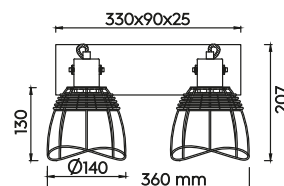



KIBITO

Baumwolle naturbelassen,
Metall Schwarz matt
Cotton natural finish,
metal black mat

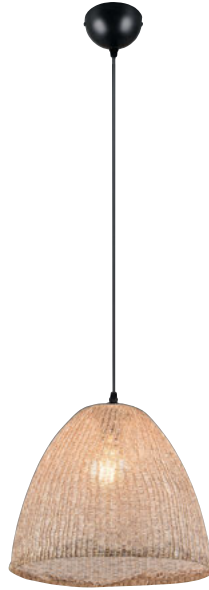

Pendelleuchte · Pendant
excl. 1 x E27
max. 10 W
R36731036

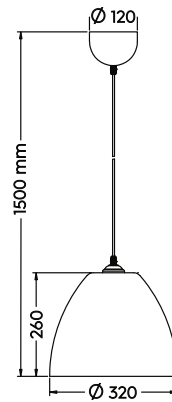

LUCILLE

Papiergarn Braun,
Metall Schwarz matt
Paper yarn brown,
metal black mat

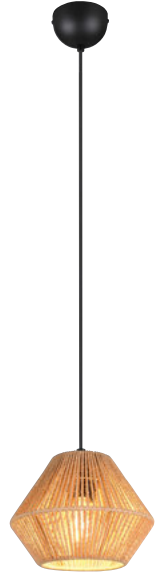

Pendelleuchte · Pendant
excl. 1 x E27
max. 28 W
R36111026

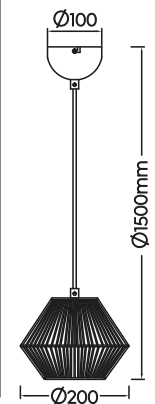

NATREL

Papiergarn naturbelassen,
Metall Schwarz matt
Paper yarn natural finish,
metal black mat



Strahler · Spot
excl. 1 x E14
max. 28 W
R86491036

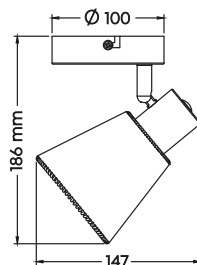

Strahler · Spot
excl. 2 x E14
max. 28 W
R86492036

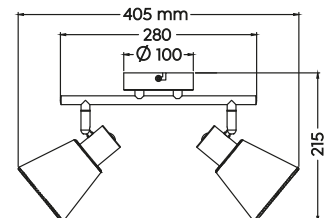

BANO

Metall Schwarz matt, Holz naturbelassen
Metal black mat, wood natural finish



Wandleuchte · Wall lamp

excl. 1 x E27

max. 10 W

R26691032

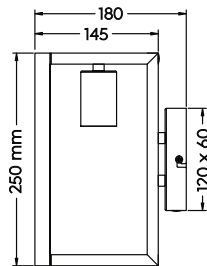

Pendelleuchte · Pendant

excl. 3 x E27

max. 10 W

R36693032

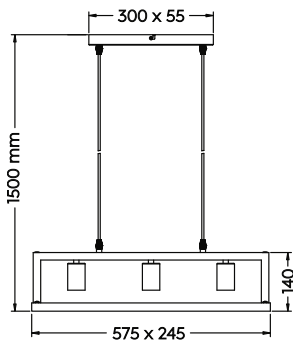

DELUME

Metall, Holz naturbelassen
Metal, wood natural finish

31 | Weiß matt · white mat

32 | Schwarz matt · black mat



Strahler · Spot

excl. 1 x E27

max. 40 W

R86671031

R86671032

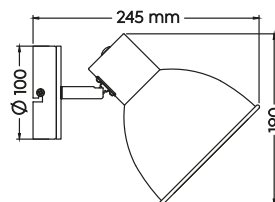

Strahler · Spot

excl. 2 x E27

max. 40 W

R86672031

R86672032

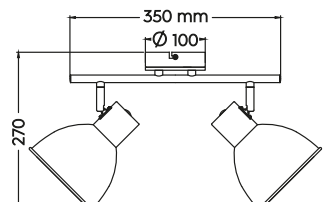



LAMEGO

Metall Schwarz matt, Holznachbildung
Metal black mat, wood imitation

Strahler · Spot
excl. 1 x E27
max. 10 W
R86681035

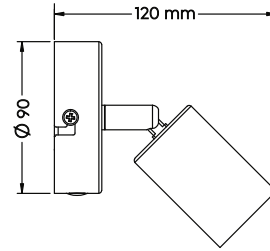

Strahler · Spot
excl. 2 x E27
max. 10 W
R86682035

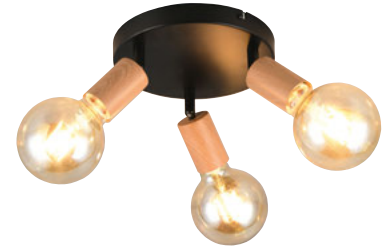
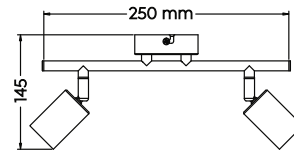

Strahler · Spot
excl. 3 x E27
max. 10 W
R86683335

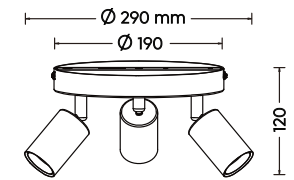

MERIDA

Metall, Holz naturbelassen
Metal, wood natural finish

- 31 | Weiß matt · white mat
- 32 | Schwarz matt · black mat

Wandleuchte · Wall lamp
excl. 1 x E27
max. 10 W
R86651031
R86651032

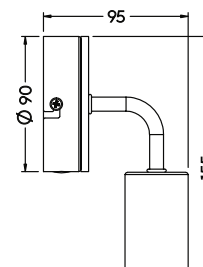

LYNAR

Metall, Holz naturbelassen
Metal, wood natural finish



Strahler · Spot
excl. 1 x E27
max. 10 W
R86661031
R86661032

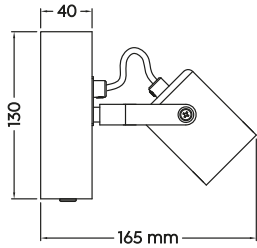

Strahler · Spot
excl. 2 x E27
max. 10 W
R86662031
R86662032

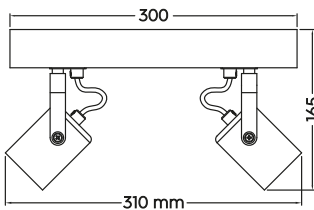

- 31 | Weiß matt · white mat
- 32 | Schwarz matt · black mat



Strahler · Spot
excl. 3 x E27
max. 10 W
R86663031
R86663032

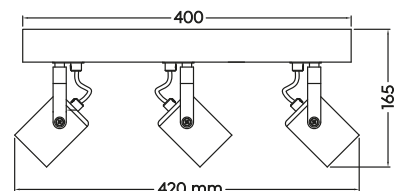

Empfohlen:
recommended:

Filament LED E27
6 W / 660 Lumen
2.700 Kelvin
988-679





CALVI

Metall, Rattangeflecht naturbelassen
Metal, rattan meshwork natural finish

 **31** | Weiß matt · white mat

 **32** | Schwarz matt · black mat



Wandleuchte · Wall lamp
excl. 1 x E14
max. 10 W
R26781732

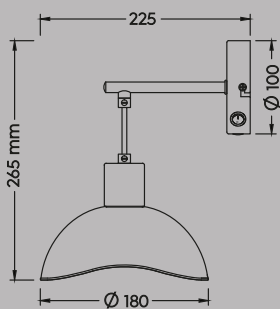

Strahler · Spot
excl. 1 x E14
max. 10 W
R86781731

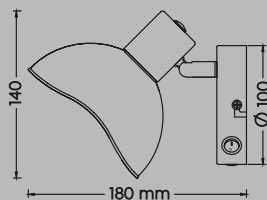

Strahler · Spot
excl. 12 x E14
max. 10 W
R86782031

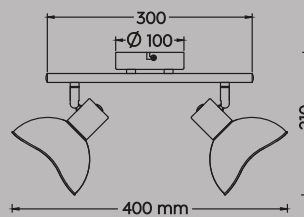

Strahler · Spot
excl. 3 x E14
max. 10 W
R86783031

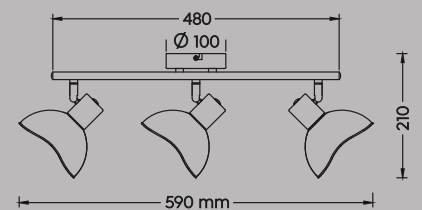



FORMENTERA

Keramik, Papier naturbelassen
 Ceramic, paper natural finish

- 15 | Grün · green
- 31 | Weiß matt · white mat
- 39 | Terracotta · terracotta



Tischleuchte · Table lamp
 excl. 1 x E14
 max. 40 W
R56801915
R56801931
R56801939

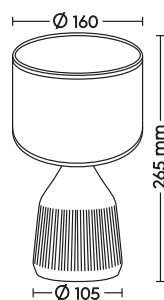

Tischleuchte · Table lamp
 excl. 1 x E27
 max. 60 W
R56801015
R56801031
R56801039

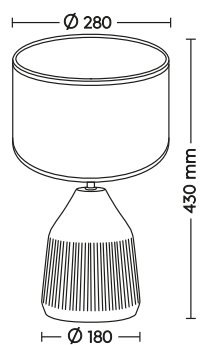

OUTDOOR



Mehr Komfort, mehr Sicherheit – die neuen Funktionen unserer Außenleuchten.

More convenience, more safety - the new functions of our outdoor lights.



MOTION SENSOR MULTICONTROL

Der integrierte Bewegungssensor der Hauptleuchte kann eine bestimmte Anzahl weiterer Leuchten mitsteuern. Die zusätzlichen Leuchten empfangen das Signal der Hauptleuchte und benötigen daher keinen eigenen Sensor.

The integrated motion sensor of the main light can also control a certain number of additional lights. The additional lights receive the signal from the main light and therefore do not require their own sensor.

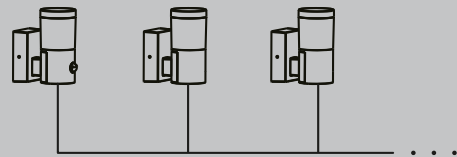

max. 8 pcs.



CONNECTOR BOX

Der Anschlusskasten dieser Leuchten ist so ausgelegt, dass er zwei Anschlussleitungen aufnehmen kann. Dadurch lassen sich mehrere Leuchten problemlos in Reihe schalten.

The connection box of these lights is designed to accommodate two connection cables. This means that several lights can be easily connected in series.

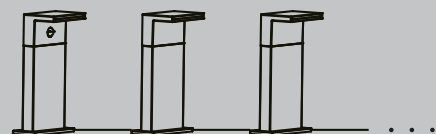

max. 8 pcs.

Robuste Außenleuchten für Küstenregionen

Robust outdoor lights for coastal regions



Leuchten, mit dem Label „Seaside Ready“, sind die perfekte Wahl für alle, die in maritimen Umgebungen leben. Dank hochwertiger Materialien und spezieller Oberflächenbeschichtungen trotzen sie selbst den härtesten Bedingungen an der Küste. Salzhaltige Luft und wechselnde Witterung können diesen Leuchten nichts anhaben.

Luminaires with the "Seaside Ready" label are the perfect choice for anyone who lives in a maritime environment. Thanks to high-quality materials and special surface coatings, they can withstand even the harshest conditions on the coast. Salty air and changing weather conditions are no match for these lights.



10 Jahre Garantie auf Korrosionsschutz bei Leuchten aus pulverbeschichtetem Aluminium. Ausgenommen sind Ausbleichen der Oberfläche sowie technische Komponenten.

10-year guarantee on corrosion protection for luminaires made of powder-coated aluminum. This excludes fading of the surface and technical components.



15 Jahre Garantie auf Korrosionsschutz bei Leuchten aus feuerverzinktem Edelstahl. Ausgenommen sind Ausbleichen der Oberfläche sowie technische Komponenten.

15-year guarantee on corrosion protection for luminaires made of hot-dip galvanized stainless steel. This excludes fading of the surface and technical components.



TANA

Metall zinkfarbig, Glas
Metal zinc-colored, glass



Wandleuchte · Wall lamp
excl. 1 x E27
max. 20 W
261060186

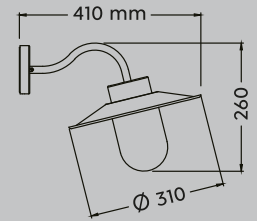

BARITO

Metall zinkfarbig, Glas weiß
Metal zinc-colored, glass white



Wandleuchte · Wall lamp
excl. 2 x E27
max. 15 W
260660286

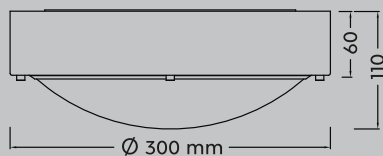

TUMEN

Metall zinkfarbig, Kunststoff weiß
Metal zinc-colored, plastic white



Wandleuchte · Wall lamp
excl. 1 x E27
max. 10 W
260560186

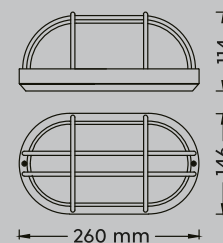



RUVUMA

Metall zinkfarbig, Glas
Metal zinc-colored, glass

Wandleuchte · Wall lamp
excl. 1 x E27
max. 10 W
262067186

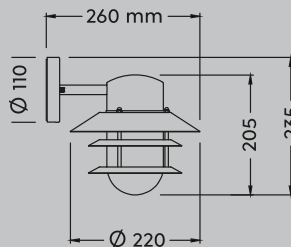

Wandleuchte · Wall lamp
excl. 1 x E27
max. 10 W
262060186

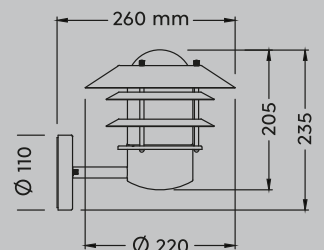

Sockelleuchte · Podestal lamp
excl. 1 x E27
max. 10 W
562060186

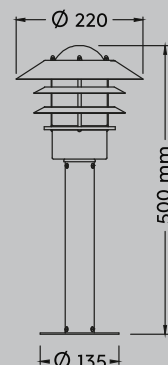

Bodenleuchte · Floor lamp
excl. 1 x E27
max. 10 W
462060186



BRENTA

Aluminium Druckguss Weiß matt, Glas
Diecast aluminium white mat, glass



Wandleuchte · Wall lamp
excl. 1 x E27
max. 40 W
201760131

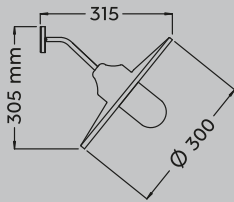

LIVENZA

Aluminium Druckguss Weiß matt, Glas
Diecast aluminium white mat, glass



Wandleuchte · Wall lamp
excl. 1 x E27
max. 40 W
205760131

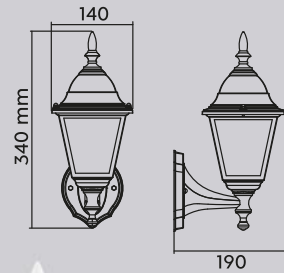

Wandleuchte · Wall lamp
excl. 1 x E27
max. 40 W
205767131

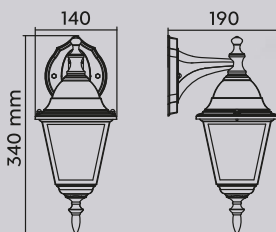

Sockelleuchte · Podestal lamp
excl. 1 x E27
max. 40 W
505760131

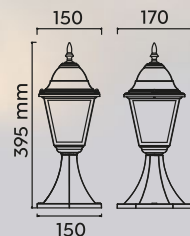



24

ATRATO

Aluminium - aluminium



42



24 | rostfarbig · rusty



42 | Anthrazit · anthracite

Empfohlen:
recommended:

LED GX53
10 W / 950 Lumen
4.000 Kelvin

953-1334



Wandleuchte · Wall lamp

excl. 1 x GX53
max. 10 W

218260124

218260142

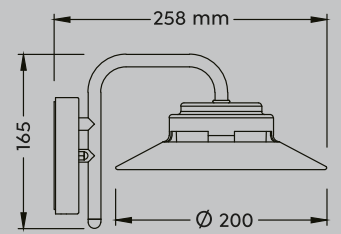

GARONNE

Aluminium Druckguss rostfarbig, Glas
Diecast aluminium rusty, glass



Wandleuchte · Wall lamp

excl. 1 x E27
max. 40 W

201860124



Wandleuchte · Wall lamp

excl. 2 x E27
max. 40 W

201860224

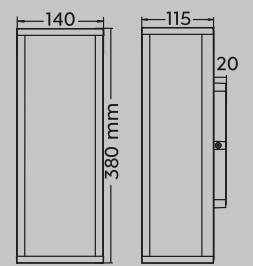
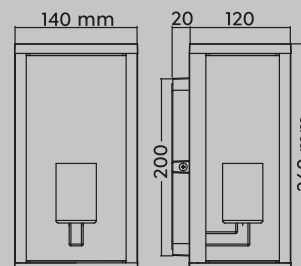



Wandleuchte · Wall lamp
 incl. SMD-LED
 13 W / 1.500 Lumen
 2.200 + 3.000 + 4.000 Kelvin
238660142

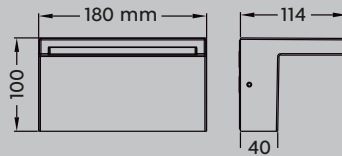

⊕ IP65



Sockelleuchte · Podestal lamp
 incl. SMD-LED
 13 W / 1.500 Lumen
 2.200 + 3.000 + 4.000 Kelvin
538660142

⊕ IP65

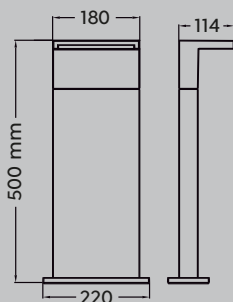

Bodenleuchte · Floor lamp
 incl. SMD-LED
 13 W / 1.500 Lumen
 2.200 + 3.000 + 4.000 Kelvin
438660142

⊕ IP65

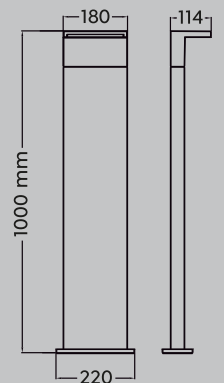

RAVI

Aluminium Druckguss Anthrazit
Diecast aluminium anthracite



DIP SWITCH



Helligkeit einstellbar ·
Adjustable light level



inkl. Verbinder für Reihenschaltung ·
Connector for series connection included

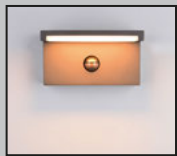

2.200 K

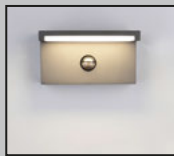

3.000 K

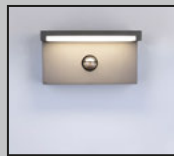

4.000 K

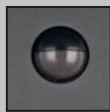
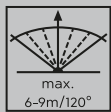

Bewegungssensor Multi-Control ·
Multi-Control motion sensor



Bewegungssensor und Orientierungslicht ·
Motion sensor and orientation light



Wandleuchte · Wall lamp
incl. SMD-LED
13 W / 1.500 Lumen
2.200 + 3.000 + 4.000 Kelvin
238669142

IP54

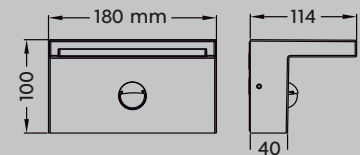

Bodenleuchte · Floor lamp
incl. SMD-LED
13 W / 1.500 Lumen
2.200 + 3.000 + 4.000 Kelvin
438669142

IP54

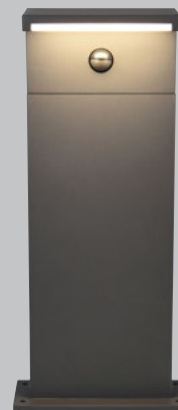
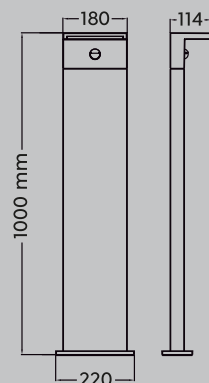

Sockelleuchte · Podestal lamp
incl. SMD-LED
13 W / 1.500 Lumen
2.200 + 3.000 + 4.000 Kelvin
538669142

IP54

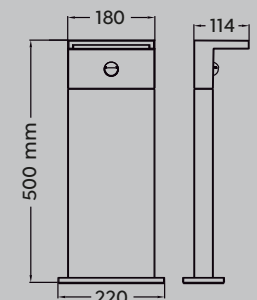

OUTDOOR

TAGUS

Aluminium Druckguss Anthrazit
Diecast aluminium anthracite



DIP SWITCH



Helligkeit einstellbar ·
Adjustable light level



inkl. Verbinder für Reihenschaltung ·
Connector for series connection included



2.200 K



3.000 K



4.000 K



Wandleuchte · Wall lamp
incl. SMD-LED
13 W / 1.500 Lumen
2.200 + 3.000 + 4.000 Kelvin
238560142

⊕ IP65

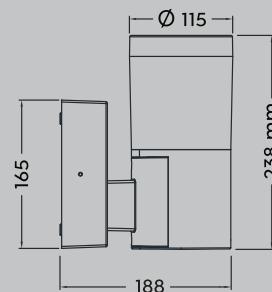

Bodenleuchte · Floor lamp
incl. SMD-LED
13 W / 1.500 Lumen
2.200 + 3.000 + 4.000 Kelvin
438560142

⊕ IP65



Sockelleuchte · Podestal lamp
incl. SMD-LED
13 W / 1.500 Lumen
2.200 + 3.000 + 4.000 Kelvin
538560142

⊕ IP65



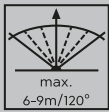

Bewegungssensor Multi-Control ·
Multi-Control motion sensor



Bewegungssensor und Orientierungslicht ·
Motion sensor and orientation light



Wandleuchte · Wall lamp
incl. SMD-LED
13 W / 1.500 Lumen
2.200 + 3.000 + 4.000 Kelvin
238569142

IP54

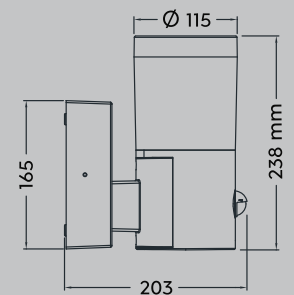

Bodenleuchte · Floor lamp
incl. SMD-LED
13 W / 1.500 Lumen
2.200 + 3.000 + 4.000 Kelvin
438569142

IP54



Sockelleuchte · Pedestal lamp
incl. SMD-LED
13 W / 1.500 Lumen
2.200 + 3.000 + 4.000 Kelvin
538569142

IP54



MURES

Aluminium Druckguss Anthrazit, Glas Weiß
Diecast aluminium anthracite, white glass

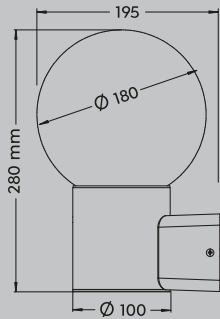

Wandleuchte · Wall lamp
excl. 1 x E27
max. 40 W
269860142

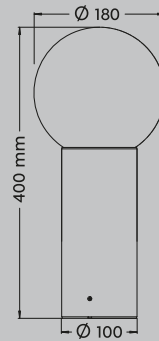

Sockelleuchte · Podestal lamp
excl. 1 x E27
max. 40 W
569860142



Bodenleuchte · Floor lamp
excl. 1 x E27
max. 40 W
469860142

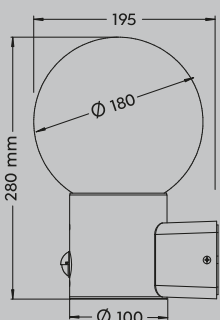

Wandleuchte · Wall lamp
excl. 1 x E27
max. 40 W
269869142

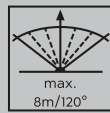

Bewegungssensor · Motion sensor

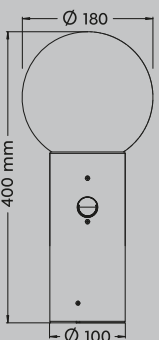

Sockelleuchte · Podestal lamp
excl. 1 x E27
max. 40 W
569869142



Bodenleuchte · Floor lamp
excl. 1 x E27
max. 40 W
469869142









TRIOTO

Edelstahl, Kunststoff Weiß
Steel, plastic white

-  **07** | Nickel matt · nickel mat
-  **32** | Schwarz matt · black mat



Wandleuchte · Wall lamp
excl. 1 x E27
max. 25 W
209760107
209760132

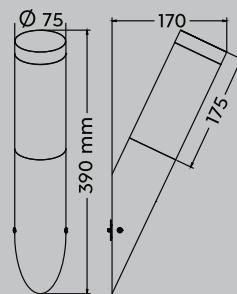

Wandleuchte · Wall lamp
excl. 1 x E27
max. 25 W
209769107
209769132

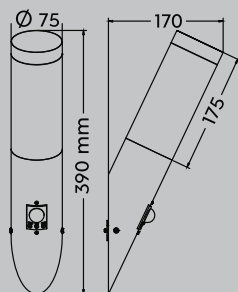
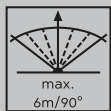

Sockelleuchte · Podestal lamp
excl. 1 x E27
max. 25 W
509760107
509760132

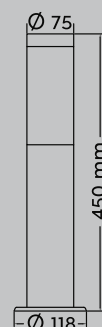

Bodenleuchte · Floor lamp
excl. 1 x E27
max. 25 W
409760107
409760132



VOLGA

Aluminium Druckguss Anthrazit, Kunststoff Weiß
Diecast aluminium anthracite, plastic white

OUTDOOR

Wandleuchte · Wall lamp

excl. 1 x E27
max. 25 W

269469142

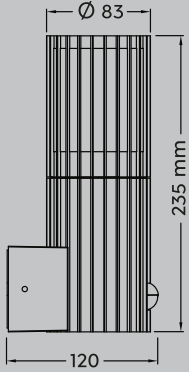

Wandleuchte · Wall lamp

excl. 1 x E27
max. 25 W

269460142

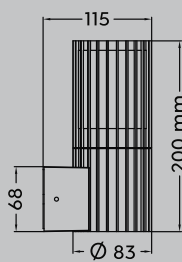

Wandleuchte · Wall lamp

excl. 1 x E27
max. 25 W

269460242

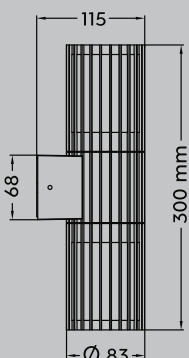

Bodenleuchte · Floor lamp

excl. 1 x E27
max. 25 W

469460142

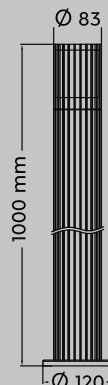

Sockelleuchte · Podestal lamp

excl. 1 x E27
max. 25 W

569460142







TURIA

Aluminium Druckguss, Glas
Diecast aluminium, glass



-  **24** | rostfarbig · rusty
-  **31** | Weiß matt · white mat
-  **42** | Anthrazit · anthracite

Empfohlen:
recommended:

LED GU10
4,5 W / 345 Lumen
3.000 Kelvin
956-5936



Wandleuchte · Wall lamp

excl. 2 x GU10
max. 5 W

260260224
260260231
260260242

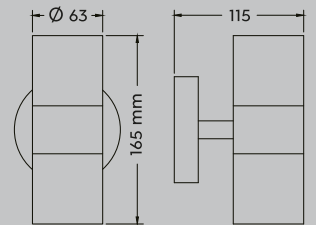

YAMUNA



Aluminium Druckguss
Diecast aluminium



Empfohlen:
recommended:

LED Mini-GU10
4 W / 345 Lumen
2.700 Kelvin

954-1432

-  **24** | rostfarbig · rusty
-  **31** | Weiß matt · white mat
-  **42** | Anthrazit · anthracite



Wandleuchte · Wall lamp

excl. 2 x GU10
max. 10 W

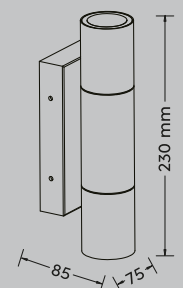

269760224
269760231
269760242





PARANA

Aluminium Druckguss
Diecast aluminium

-  **31** | Weiß matt · white mat
-  **42** | Anthrazit · anthracite



Empfohlen:
recommended:

LED GU10
4,5 W / 345 Lumen
3.000 Kelvin
956-5936



Wandleuchte · Wall lamp
excl. 2 x GU10
max. 5 W
269560231
269560200

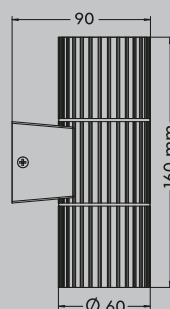

Wandleuchte · Wall lamp
excl. 1 x GU10
max. 5 W
269560131
269560100

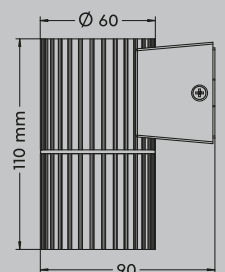



BENI

Metall, Glas · Metal, glass



 **31** | Weiß matt · white mat

 **42** | Anthrazit · anthracite



Wandleuchte · Wall lamp

excl. 1 x GU10
max. 5 W

260360131
260360142

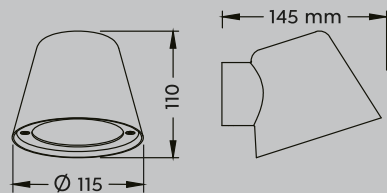

Empfohlen:
recommended:

LED GU10
4,5 W / 345 Lumen
3.000 Kelvin

956-5936



Sockelleuchte · Podestal lamp

excl. 1 x GU10
max. 5 W

560360131
560360142

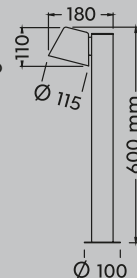

Bodenleuchte · Floor lamp

excl. 1 x GU10
max. 5 W

460360131
460360142



BRAGA

Metall, Glas · Metal, glass

 **31** | Weiß matt · white mat

 **32** | Schwarz matt · black mat

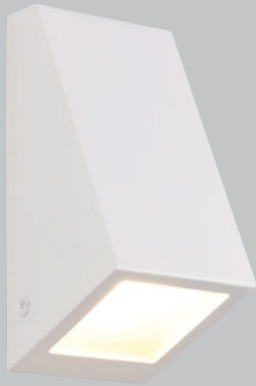

Wandleuchte · Wall lamp

excl. 1 x GU10

max. 10 W

R26971631

R26971632



Empfohlen:
recommended:

LED GU10
4,5 W / 345 Lumen
3.000 Kelvin

956-5936

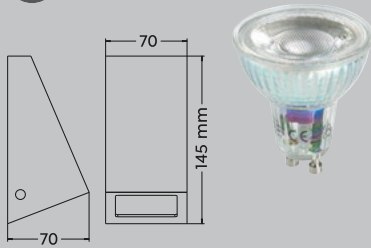

OUTDOOR

AMBATO

Kunststoff · Plastic

 Stoßfest gemäß IK10 ·
Shock-resistant according to IK10

 **31** | Weiß matt · white mat

 **32** | Schwarz matt · black mat



Wandleuchte · Wall lamp

excl. 1 x E27

max. 10 W

R26931631

R26931632

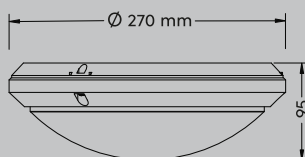



CUSCO

Kunststoff Schwarz matt
Plastic black mat



Wandleuchte · Wall lamp
incl. LED GX53
10 W / 950 Lumen
4.000 Kelvin
R26961632

Wandleuchte · Wall lamp
incl. LED GX53
2 x 10 W / 2 x 950 Lumen
4.000 Kelvin
R26962632

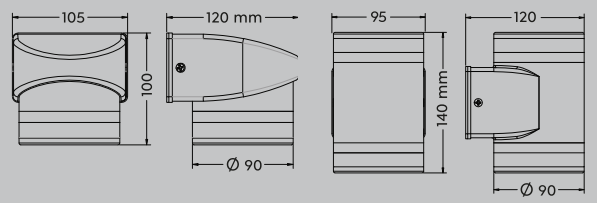

ELVAS

Kunststoff · Plastic



- Bewegungssensor · Motion sensor
- Dämmerungssensor · Dusk sensor



- 31** | Weiß matt · white mat
- 32** | Schwarz matt · black mat

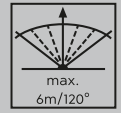

Wandleuchte · Wall lamp
incl. SMD-LED
3 W / 38 s0 Lumen
4.000 Kelvin
R25129631
R25129632

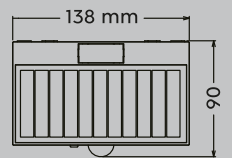



3.000 K



4.000 K



6.000 K

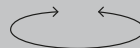
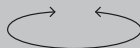

TALCA

Kunststoff · Plastic



Lichtfarbe einstellbar · Adjustable light color



Bewegungssensor · Motion sensor



Dämmerungssensor · Dusk sensor



Memory Funktion · Memory function

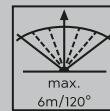

31 | Weiß matt · white mat



32 | Schwarz matt · black mat

Wandleuchte · Wall lamp
incl. SMD-LED
2,5 W / 330 Lumen
3.000 + 4.000 + 6.000 Kelvin

R25119631

R25119632



IP65

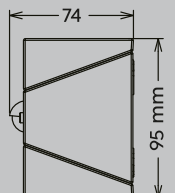
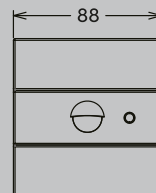



SCOOP

Edelstahl Schwarz matt
Steel black mat

3er Set • Set of 3

In der Höhe anpassbar (55 / 75 / 95 cm)
Height adjustable (55 / 75 / 95 cm)

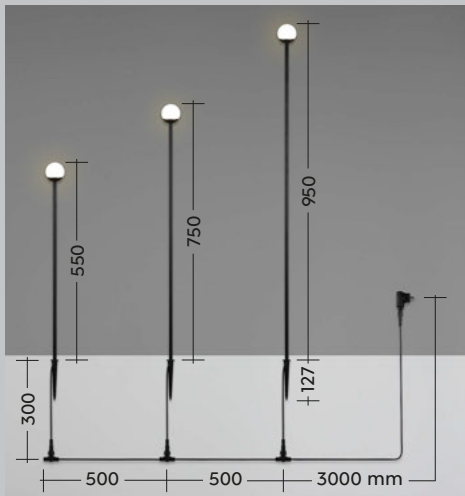

Gartenleuchte · Garden lamp
incl. 3 x LED
3 x 1,5 W / 3 x 160 Lumen
3.000 Kelvin
R45863632



STICK

Edelstahl Schwarz matt
Steel black mat

3er Set • Set of 3

In der Höhe anpassbar (55 / 75 / 95 cm)
Height adjustable (55 / 75 / 95 cm)

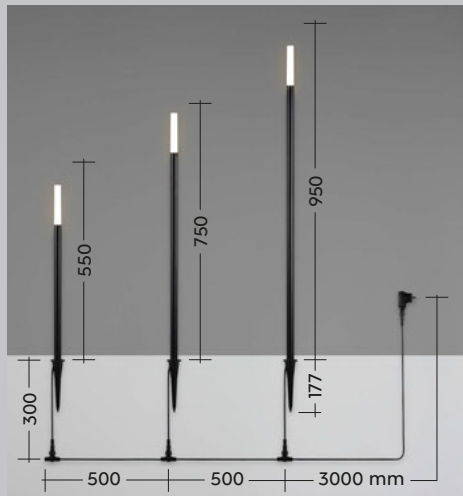

Gartenleuchte · Garden lamp
incl. 3 x LED
3 x 3,5 W / 3 x 330 Lumen
3.000 Kelvin
R45853632



PURUS

Aluminium Druckguss Anthrazit
Diecast aluminium anthracite

3er Set • Set of 3

In der Höhe anpassbar (55 / 75 / 95 cm)
Height adjustable (55 / 75 / 95 cm)



Strahler · Spot
excl. 1 x GU10
max. 5 W
R86871042

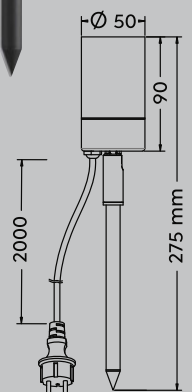

EMBER

Kunststoff Schwarz, Hanf naturbelassen
Plastic black, hemp natural finish



Lichterkette · Fairy lights
incl. 8 x LED
8 x 0,4 W / 8 x 45 Lumen
2.700 Kelvin
R74938602

8fl.
6,00 m

IP44

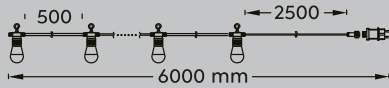

OUTDOOR

CHAIN

Kunststoff Schwarz matt, Papiergarn naturbelassen
Plastic black mat, paper yarn natural finish

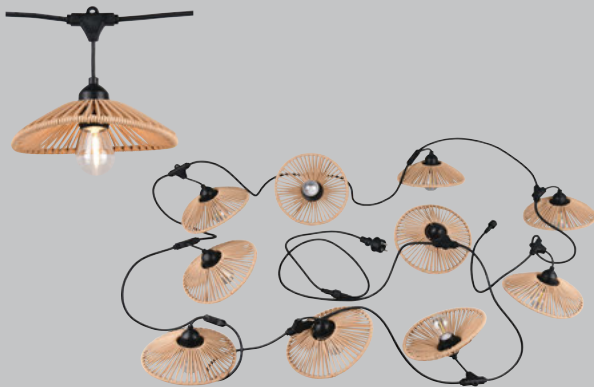

Lichterkette · Fairy lights
incl. 10 x LED E27
10 x 1 W / 10 x 80 Lumen
3.000 Kelvin
R74771532

10fl.
6,50 m

IP44

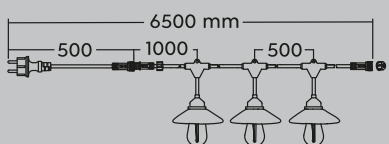

Verlängerbar bis max. 6 Stück ·
extendable up to 6 pieces

PRODUKTEIGENSCHAFTEN

Features · Caractéristiques · Kenmerken · Acabados ·
Caratteristiche · Caracteristici · Ominaisuudet · Cechy



Schalter · Switch

Interrupteur · Schakelaar · Interruptor ·
Interruttore · Intrerupator · Kytkin ·
Przełącznik



Fußschalter · Footswitch

interrupteur à pédale · Voetschakelaar ·
Interruptor de pie · interruttore a pedale ·
comutator picior · Päälle / pois jalkakytin ·
wyłącznik nożny



Schnurschalter · Cable switch

Interrupteur de cordon · Snoerschakelaar ·
Cable de interruptor · Interruttore su cavo ·
Intrerupator cu cablu · katkaisin ja johto ·
Przełącznik na kablu



Getrennt schaltbar · Separately switchable

Interrupteurs séparés · Gescheiden schakelbaar ·
Interruptores separados · Interruttori separati ·
Intrerupatoare separate · Erikseen kytkettävissä ·
Oddzieleny przełącznik



Fernbedienung · Remote control

Commande à distance · Afstandsbediening ·
Mando a distancia · Comando a distanza ·
Telecomanda · Kauko-ohjain · Pilot



Integrierter Dimmer · Integrated dimmer

Variateur intégré · Geïntegreerde dimmer ·
Regulador integrado · Dimmer integrato ·
Variator de lumina integrat · Integroitu himmennin ·
Wbudowany ściemniacz



Sensordimmer · Sensor dimmer

Variateur tactile · Touchdimmer ·
Regulador con sensor · Touchdimmer ·
Variator cu senzor · Kosketushimmennin ·
Czujnik ściemniania



Extern dimmbar · Externally dimmable

Dimmable avec variateur externe · Extern dimbaar ·
Dimmable por regulador externo · Dimmerabile con
dimmer esterno · variator extern de lumina ·
himmennettävissä · Zewnętrznie ściemniania



RGB Farbwechsler · RGB Colorchanging

Changement de couleur RGB · RGB Kleurverandering ·
Cambio de color RGB · Cambia colore RGB ·
Schimbator de culoare RGB · Värinvaihto RGB ·
Zmieniający kolor RGB



Lichtfarbe einstellbar · Adjustable light color

Couleur de lumière réglable · Lichtkleur instelbaar ·
Color de luz regulable · Colore della luce regolabile ·
Lumina colorata reglabila · Värilämpötila säädettävissä ·
Regulowana barwa światła



Schwenkbar · Slewable

Pivotant · Draaibaar · Pivotante ·
Girevole · Pivotant · Suunnattava ·
Skretny



DIP SWITCH

Lichtfarben direkt an der Leuchte einstellbar ·
Colours directly adjustable at the lamp

Les couleurs de la lumière peuvent être réglées
directement sur le luminaire · Lichtkleuren direct
instelbaar op de lamp · Tonalidades de luz ajustables
directamente en la lámpara · Colori della luce regolabili
direttamente sulla lampada · Colori ale luminii reglabile
direct de la bec · Valon väri asetettävissä suoraan
valaisimesta · Barwy światła można ustawić bezpośrednio
na oprawie



LIFT ME

Innovative Höhenverstellung ohne Gegengewicht ·
Innovative height adjustment without counterweight ·
Nouveau! Réglage de la hauteur sans contrepoids ·
Innovatieve hoogteverstelling zonder contragewicht ·
Innovador sistema de ajuste de altura sin necesidad de
contrapeso · Regolazione innovativa dell'altezza senza
contrappeso · Ajustare inovativa a înaltimei fara
contragreutate · Innovatiivinen korkeuden säätö ilman
vastapainoa · Innowacyjna regulacja wysokości bez
przeciwwagi



4 fach TOUCH · 4 level Touch function

Interrupteur tactile 4 niveaux · Touch schakelaar 4 niveaus ·
Función Táctil 4 nivel · Interruttore touch 4 livelli ·
Intrerupator tactil 4 nivele · Kosketuskäyttöinen 4 taso ·
Funkcja dotykowa 4 poziomy



Flexibel · Flexible

Flexible · Flexibel · Flexible · Flessibile ·
Flexibil · Joustava · Elastyczny



USB-C Anschluss · USB-C connection

Entrée USB-C · USB-C-aansluiting · Conexión USB-C ·
Connessione USB-C · Conexiune USB-C ·
USB-C-liitäntä · Połączenie USB-C



Nachtlicht · Night light

Veilleuse de nuit · Nachtlicht · Luz de la noche ·
Luce notturna · Lampă de noapte · Yövalo ·
Lampka nocna



Helligkeit einstellbar · Adjustable light level

Niveau d'éclairage ajustable · Instelbaar lichtniveau ·
Nivel de luz ajustable · Livello di luce regolabile ·
Nivelul de lumină reglabil · Säädettävä valon taso ·
Regulowana jasność światła



Akkubetrieb · Rechargeable battery operated

Fonctionnement sur batteries rechargeables · Werkt op
herlaadbare batterijen · Batería recargable · Batteria
Ricaricabile · Operabil prin baterie reincarcabilă ·
Ladattava akku · Akumulator zasilany baterijnie



Timer · Timer

Minuterie · Timer · Temporizador · Timer ·
Temporizator · Ajastin · Timer



Up and down Beleuchtung · Up and Down lighting

Point lumineux en haut et en bas · Lichtpunt boven en
onder · Luz de arriba y abajo · Luce su e giù · Sus și în
jos lumina · Ylös ja alas valoa · W górę iw dół światło



Dimmbar mit Schalter · Dimmable via switch
 Réglable avec interrupteur · Dimbaar via schakelaar ·
 Regulable mediante interruptor · Dimmerabile tramite
 interruttore · Estompat prin comutator · Himmennettävä
 kytkimen · Ściemnialne za pośrednictwem przełącznika



Ohne Leuchtmittel · Lamp(s) excluded
 Sans ampoule(s) · Zonder lichtbron(nen) ·
 Sin bombilla(s) · Lampadina Esclusa · Fara bec (s) ·
 Ilman polttimo (s) · Bez żarówki (s)



Memory Funktion · Memory function
 fonction mémoire · Geheugen functie ·
 Función de memoria · Funzione memorizzazione ·
 funcția memorie · Muistitoiminto · Funkcja pamięci



indirekte Beleuchtung · indirect lighting
 lumière indirecte · indirecte belichting ·
 Iluminación indirecta · Illuminazione a scomparsa ·
 iluminat indirect · epäsuora valaistus ·
 oświetlenie pośrednie



Hakenbefestigung · Hook mounting
 Montage du crochet · Haakbevestiging ·
 Montaje con gancho · Montaggio a gancio ·
 Montarea cârligului · Koukun kiinnitys ·
 Montaż na haku



Bewegungssensor · Motion sensor
 Détecteur de mouvement · Bewegungssensor ·
 Sensor de movimiento · Sensore di movimento ·
 Senzor de mișcare · Liiketunnistin · Czujnik ruchu



USB Anschluss · USB connection
 Entrée USB · USB-aansluiting · Conexión USB ·
 Connessione USB · Conexiune USB · USB-liitäntä ·
 Połączenie USB



Solar · Solar
 Solaire · Solair · Solar · Solare · Solar ·
 Aurinkokenno · Solar



FLEXconnect ready



Mini GU10



Stoßfest gemäß IK10 · Shock-resistant according to IK10
 Résistance aux chocs selon IK10 · Slagvast volgens IK10 ·
 Resistente a impactos según IK10 · Resistente agli urti
 secondo IK10 · Rezistent la impact în conformitate cu IK10 ·
 Iskunkestävä IK10:n mukaan · Odporność na uderzenia
 zgodnie z IK10



Bewegungssensor Multi-Control

Der integrierte Bewegungssensor der Hauptleuchte kann eine bestimmte Anzahl weiterer Leuchten mitsteuern. Die zusätzlichen Leuchten empfangen das Signal der Hauptleuchte und benötigen daher keinen eigenen Sensor.

Multi-Control motion sensor

The integrated motion sensor of the main light can also control a certain number of additional lights. The additional lights receive the signal from the main light and therefore do not require their own sensor.

Capteur de mouvement Multi-Control

Le capteur de mouvement intégré du luminaire principal peut également commander un certain nombre de luminaires supplémentaires. Les luminaires supplémentaires reçoivent le signal du luminaire principal et n'ont donc pas besoin de leur propre capteur.

Multi-Control bewegingssensor

De geïntegreerde bewegingssensor van de hoofdlamp kan ook een bepaald aantal extra lampen aansturen. De extra lampen ontvangen het signaal van de hoofdlamp en hebben dus geen eigen sensor nodig.

Sensor de movimiento Multi-Control

El sensor de movimiento integrado de la luz principal también puede controlar un cierto número de luces adicionales. Las luces adicionales reciben la señal de la luz principal y, por tanto, no necesitan su propio sensor.

Sensore di movimento Multi-Control

Il sensore di movimento integrato nella luce principale può controllare anche un certo numero di luci aggiuntive. Le luci supplementari ricevono il segnale dalla luce principale e non necessitano quindi di un proprio sensore.

Senzor de mișcare Multi-Control

Senzorul de mișcare integrat al luminii principale poate controla, de asemenea, un anumit număr de lumini suplimentare. Luminile suplimentare primesc semnalul de la lumina principală și, prin urmare, nu au nevoie de un senzor propriu.

Multi-Control liiketunnistin

Päävalon integroitu liiketunnistin voi ohjata myös tiettyä määrää lisävaloja. Lisävalot saavat signaalin päävalosta, joten ne eivät tarvitse omaa tunnistinta.

Czujnik ruchu Multi-Control

Zintegrowany czujnik ruchu głównego światła może również sterować pewną liczbą dodatkowych świateł. Dodatkowe światła odbierają sygnał z głównego światła i dlatego nie wymagają własnego czujnika.



Inkl. Verbinder für Reihenschaltung

Der Anschlusskasten dieser Leuchten ist so ausgelegt, dass er zwei Anschlussleitungen aufnehmen kann. Dadurch lassen sich mehrere Leuchten problemlos in Reihe schalten.

Connector for series connection included

The connection box of these lights is designed to accommodate two connection cables. This means that several lights can be easily connected in series.

Connecteur pour connexion en série inclus

Le boîtier de raccordement de ces luminaires est conçu de manière à pouvoir accueillir deux câbles de raccordement. Il est ainsi possible de brancher plusieurs luminaires en série sans problème.

Connector voor serieaansluiting inbegrepen

De aansluitdoos van deze lampen is zo ontworpen dat er twee aansluitkabels in passen. Dit betekent dat meerdere lampen eenvoudig in serie kunnen worden aangesloten.

Conector para conexión en serie incluido

La caja de conexiones de estas luces está diseñada para alojar dos cables de conexión. Esto permite conectar fácilmente varias luces en serie.

Connettore per il collegamento in serie incluso

La scatola di connessione di queste luci è progettata per ospitare due cavi di collegamento. In questo modo è possibile collegare facilmente più luci in serie.

Conector pentru conectarea în serie inclus

Năiden valaisimien liitäntäkotelo on suunniteltu siten, että siihen mahtuu kaksi liitäntäkäapeliä. Tämä tarkoittaa, että useita valoja voidaan helposti kytkeä sarjaan.

Mukana liitin sarjakytkentää varten

Näiden valaisimien liitäntäkotelo on suunniteltu siten, että siihen mahtuu kaksi liitäntäkäapeliä. Tämä tarkoittaa, että useita valoja voidaan helposti kytkeä sarjaan.

W zestawie złącze do połączenia szeregowego

Skrzynka połączeniowa tych świateł została zaprojektowana tak, aby pomieścić dwa kable połączeniowe. Oznacza to, że kilka lamp można łatwo połączyć szeregowo.



Geeignet für Küstengebiete 10 Jahre

10 Jahre Garantie auf Korrosionsschutz bei Leuchten aus pulverbeschichtetem Aluminium. Ausgenommen sind Ausbleichen der Oberfläche sowie technische Komponenten.

Seaside ready (10 years)

10-year guarantee on corrosion protection for luminaires made of powder-coated aluminum. This excludes fading of the surface and technical components.

Seaside ready (10 ans)

10 ans de garantie contre la corrosion pour les luminaires en aluminium thermolaqué. Sont exclus la décoloration de la surface ainsi que les composants techniques.

Klaar voor de kust (10 jaar)

10 jaar garantie op corrosiebescherming voor armaturen gemaakt van gepoedercoat aluminium. Dit sluit verbleking van het oppervlak en technische onderdelen uit.

Seaside ready (10 años)

10 años de garantía de protección contra la corrosión para luminarias de aluminio con recubrimiento de polvo. Esto excluye la decoloración de la superficie y los componentes técnicos.

Seaside ready (10 anni)

Garanzia di 10 anni sulla protezione dalla corrosione per gli apparecchi di illuminazione in alluminio verniciato a polvere. Questo esclude lo sbiadimento della superficie e dei componenti tecnici.

Seaside ready (10 ani)

Garanție de 10 ani privind protecția împotriva coroziunii pentru corpurile de iluminat din aluminiu acoperit cu pulbere. Aceasta exclude decolorarea suprafeței și a componentelor tehnice.

Seaside ready (10 vuotta)

10 vuoden korroosiosuojatakuu jauhemaalattusta alumiinista valmistetuille valaisimille. Tämä ei koske pinnan ja teknisten osien haalistumista.

Seaside ready (10 lat)

10-letnia gwarancja na ochronę antykorozyjną opraw oświetleniowych wykonanych z aluminium malowanego proszkowo. Nie obejmuje to blaknięcia powierzchni i elementów technicznych.



Geeignet für Küstengebiete 15 Jahre

15 Jahre Garantie auf Korrosionsschutz bei Leuchten aus feuerverzinktem Edelstahl. Ausgenommen sind Ausbleichen der Oberfläche sowie technische Komponenten.

Seaside ready (15 years)

15-year guarantee on corrosion protection for luminaires made of hot-dip galvanized stainless steel. This excludes fading of the surface and technical components.

Seaside ready (15 ans)

15 ans de garantie contre la corrosion pour les luminaires en acier inoxydable galvanisé à chaud. Sont exclus la décoloration de la surface ainsi que les composants techniques.

Klaar voor de kust (15 jaar)

15 jaar garantie op corrosiebescherming voor armaturen gemaakt van thermisch verzinkt roestvrij staal. Dit sluit verbleking van het oppervlak en technische onderdelen uit.

Seaside ready (15 años)

15 años de garantía de protección contra la corrosión para luminarias de acero inoxidable galvanizado en caliente. Esto excluye la decoloración de la superficie y los componentes técnicos.

Seaside ready (15 anni)

Garanzia di 15 anni sulla protezione dalla corrosione per gli apparecchi di illuminazione in acciaio inox zincato a caldo. Questo esclude lo sbiadimento della superficie e dei componenti tecnici.

Seaside ready (15 ani)

Garanție de 15 ani privind protecția împotriva coroziunii pentru corpurile de iluminat din oțel inoxidabil galvanizat la cald. Aceasta exclude decolorarea suprafeței și a componentelor tehnice.

Seaside ready (15 vuotta)

15 vuoden korroosiosuojatakuu kuumasinkitystä ruostumattomasta teräksestä valmistetuille valaisimille. Tämä ei koske pinnan ja teknisten osien haalistumista.

Seaside ready (15 lat)

15-letnia gwarancja na ochronę antykorozyjną opraw oświetleniowych wykonanych ze stali nierdzewnej ocynkowanej ognioowo. Nie obejmuje to blaknięcia powierzchni i elementów technicznych.

FARBEN & MATERIALIEN

Colours and materials · Couleurs et matériaux · Kleuren en materialen · Colores y materiales ·
Colori e materiali · Culori si materiale · Värit ja materiaalit · Kolory i materiały · Renkler ve malzemeler

- 01** Weiß · white
blanc · wit · blanco · bianco · alb · valkoinen · biały
- 02** Schwarz · black
noir · zwart · negro · nero · negru · musta · czarny
- 04** Altmessing · old brass
laiton fumé · oud brons · bronce viejo · ottone invecchiato ·
bronz antic · antiikkimessinki · patyna
- 06** Chrom · chrome
chrome · chroom · cromo · cromo · crom ·
kromi · chrom
- 07** Nickel matt · nickel mat
nickel mat · nikkelt mat · níquel mate · nichel opaco ·
nichel mat · harjattu teräs · nikiel mat
- 08** Messing matt · brass mat
laiton mat · messing mat · bronce mate · ottone satinato ·
bronz mat · mattamessinki · mosiądz mat
- 12** Blau · blue
bleu · blauw · azul · azzurro · albastru · sininen · niebieski
- 13** Amber · amber
ambre · amber · ámbar · ambra · amber · meripihka ·
bursztynowy
- 14** alabasterfarbig · alabaster coloured
couleur albâtre · albastkleurig · color alabastro ·
color alabastro · colorat în alabastru · alabasterin värinen ·
kolor alabastrowy
- 15** Grün · green
vert · groen · verde · verde · verde · vihreä · zielony
- 17** mehrfarbig · multicolor
multicolore · multicolor · multicolor · multicolore ·
multicolor · monivärinen · multi-kolor
- 24** rostfarbig · rusty
rouille · roestkleur · óxido · ruggine · ruginiu · rustiikki ·
miedz
- 26** Braun · brown
brun · bruin · marrón · marrone · maro · ruskea · brązowy
- 28** rostfarbig antik · antique rust
rouille antique · roestkleur antiek · oxido · ruggine anticato ·
ruginiu antic · rustiikki · antyczny rdzawy
- 31** Weiß matt · white mat
blanc mat · wit mat · estera blanca · bianco opaco · alb mat ·
valkoinen matto · biały mat
- 32** Schwarz matt · black mat
noir mat · mat zwart · estera negra · nero opaco ·
negru mat · musta matto · czarny mat
- 35** Holznachbildung · wood imitation
imitation bois · houtimitatie · imitación de madera ·
effetto legno · imitație de lemn · puujäljitelmä ·
imitacja drewna
- 36** naturbelassen · natural finish
finition naturelle · natuurlijke afwerking · acabado natural ·
finitura naturale · finisaj natural · luonnollinen viimeistely ·
naturalne wykończenie
- 39** Terrakotta · terracotta
terre cuite · terracotta · terracota · terracotta ·
teracotă · terrakotta · terakota
- 40** Apricot · apricot
abricot · abrikoos · albaricoque · apricot ·
caise · aprikoosi · morela
- 42** Anthrazit · anthracite
antracite · antraciet · antracita · antracite · antracit ·
antrasiitti · antracyt
- 43** Warm Beige · warm beige
beige chaud · warm beige · beige cálido · beige caldo ·
bej cald · lämmin beige · ciepły beż
- 52** Transparent klar · transparent clear
transparent claire · transparant helder · transparente claro ·
transparente chiaro · transparent clar · kirkas · przezroczysty
- 54** rauchfarbig · smoke
fumé · rookkleur · humo · fume' · fumuriu ·
savu · przydymiony
- 65** Coffee · coffee
café · koffie · café · caffè · cafea · antiikkiteräs · kawa
- 76** Warm Grau · Warm Grey
Gris chaud · Warm grijs · Gris cálido · Grigio caldo · Gri cald ·
Lämmin harmaa · Ciepły szary
- 79** goldfarbig · gold
or · goud · oro · oro · aur · kultaa · złota
- 80** Schwarz-Gold · black-gold
noir et or · zwart-goud · negro-oro · oro nero ·
negru-auriu · musta-kulta · czarno złoty
- 86** zinkfarbig · zinc-colored
couleur zinc · zink kleur · color zinc · color Zinco ·
culoarea zincului · antiikkihopea · kolor cynkowy
- 87** titanfarbig · titan
titane · titaan · titán · titano · titaniu ·
titaani · tytanowy
- 89** silberfarbig · silver
argent · zilver · plata · argento · argint · purppura · srebrny
- 91** Lila · lilac
lilla · lilla · lila · lilla · lila · pastellin pinkki · liliowy
- 93** Pink · pink
rose · pink · pink · rosa · pink · musta-hopea · różowy

Artikel-Nr. product no.	Serie series	Seite page	EAN-Nummer EAN-number	Artikel-Nr. product no.	Serie series	Seite page	EAN-Nummer EAN-number
201101101	WACADIA	14	4017807692303	438660142	RAVI	56	4017807686920
201102101	DADI	14	4017807692341	438669142	RAVI	57	4017807686937
201103201	SEPANTA	14	4017807692365	442410107	AMADOR	7	4017807688184
201104401	MATTONI	14	4017807692396	442410132	AMADOR	7	4017807688160
201105201	RAPOSA	14	4017807692433	442410165	AMADOR	7	4017807688177
201106101	VANJURA	14	4017807692471	460360131	BENI	66	4017807691634
201760131	BRENTA	54	4017807687354	460360142	BENI	66	4017807691450
201860124	GARONNE	55	4017807687378	462060186	RUVUMA	53	4017807687736
201860224	GARONNE	55	4017807687392	469460142	VOLGA	63	4017807687064
205760131	LIVENZA	54	4017807693690	469860142	MURES	60	4017807687309
205767131	LIVENZA	54	4017807693683	469869142	MURES	60	4017807687323
209760107	TRIOTO	62	4017807556551	505760131	LIVENZA	54	4017807693720
209760132	TRIOTO	62	4017807648201	509760107	TRIOTO	62	4017807556575
209769107	TRIOTO	62	4017807693744	509760132	TRIOTO	62	4017807648225
209769132	TRIOTO	62	4017807648218	523310907	MONZA	6	4017807693263
218260124	ATRATO	55	4017807691276	523310908	MONZA	6	4017807693294
218260142	ATRATO	55	4017807691177	523310932	MONZA	6	4017807693256
237770131	CASSINO	13	4017807683240	538560142	TAGUS	58	4017807686838
237770132	CASSINO	13	4017807683202	538569142	TAGUS	59	4017807686845
237779131	CASSINO	13	4017807683257	538660142	RAVI	56	4017807686906
237779132	CASSINO	13	4017807683226	538669142	RAVI	57	4017807686913
237870131	TARSIA	2	4017807683301	560360131	BENI	66	4017807691597
237970131	NAPOLI	5	4017807683486	560360142	BENI	66	4017807691436
237970132	NAPOLI	5	4017807683431	562060186	RUVUMA	53	4017807687712
238170131	AROLA	4	4017807683592	569460142	VOLGA	63	4017807687026
238170132	AROLA	4	4017807683530	569860142	MURES	60	4017807687262
238270132	ARPINO	12	4017807683639	569869142	MURES	60	4017807687286
238270332	ARPINO	12	4017807683622	636714131	RIVA	10	4017807682939
238560142	TAGUS	58	4017807686807	636716131	RIVA	10	4017807682915
238569142	TAGUS	59	4017807686821	636719131	RIVA	10	4017807682953
238660142	RAVI	56	4017807686876	636810631	ZAYA	8	4017807684988
238669142	RAVI	57	4017807686890	636810665	ZAYA	8	4017807684995
240319132	MIO	12	4017807673203	636819631	ZAYA	8	4017807682991
240319143	MIO	12	4017807677898	636819665	ZAYA	8	4017807683004
260260224	TURIA	64	4017807691320	636910631	OVELA	8	4017807685008
260260231	TURIA	64	4017807691344	636910665	OVELA	8	4017807685015
260260242	TURIA	64	4017807691306	637810131	TARSIA	2	4017807683387
260360131	BENI	66	4017807691566	637910231	NAPOLI	5	4017807683493
260360142	BENI	66	4017807691412	637910232	NAPOLI	5	4017807683455
260560186	TUMEN	52	4017807691719	638110131	AROLA	4	4017807683615
260660286	BARITO	52	4017807691887	638110132	AROLA	4	4017807683578
261060186	TANA	52	4017807691672	954-1123	LED LM MINI	29	4017807679502
262060186	RUVUMA	53	4017807687675	954-1432	LED LM MINI	29	4017807679526
262067186	RUVUMA	53	4017807687699	954-1534	LED LM MINI	29	4017807679540
269370131	PRATELLA	12	4017807683271	R25119631	TALCA	69	4017807691610
269370132	PRATELLA	12	4017807683264	R25119632	TALCA	69	4017807691658
269460142	VOLGA	63	4017807686944	R25129631	ELVAS	68	4017807691528
269460242	VOLGA	63	4017807686982	R25129632	ELVAS	68	4017807691542
269469142	VOLGA	63	4017807690965	R26691032	BANO	45	4017807670899
269560131	PARANA	65	4017807687125	R26721080	SAMDEL	42	4017807672299
269560142	PARANA	65	4017807687101	R26781732	CALVI	48	4017807680102
269560231	PARANA	65	4017807687163	R26851731	TARYN	29	4017807685688
269560242	PARANA	65	4017807687149	R26851732	TARYN	29	4017807685671
269760224	YAMUNA	64	4017807687477	R26851765	TARYN	29	4017807685695
269760231	YAMUNA	64	4017807687453	R26852731	TARYN	29	4017807688726
269760242	YAMUNA	64	4017807687439	R26852732	TARYN	29	4017807688702
269860142	MURES	60	4017807687187	R26852765	TARYN	29	4017807688740
269869142	MURES	60	4017807687200	R26931631	AMBATO	67	4017807691474
337810131	TARSIA	2	4017807683349	R26931632	AMBATO	67	4017807691498
337810331	TARSIA	3	4017807683363	R26961632	CUSCO	68	4017807687507
337810531	TARSIA	3	4017807683400	R26962632	CUSCO	68	4017807687521
337819131	TARSIA	2	4017807683325	R26971631	BRAGA	67	4017807687552
337910231	NAPOLI	5	4017807683509	R26971632	BRAGA	67	4017807687576
337910232	NAPOLI	5	4017807683462	R33111131	MANSA	16	4017807682151
409760107	TRIOTO	62	4017807556599	R33111132	MANSA	16	4017807682144
409760132	TRIOTO	62	4017807687415	R33551106	SENTA	17	4017807685800
423310207	MONZA	6	4017807691030	R33551142	SENTA	17	4017807697773
423310208	MONZA	6	4017807691061	R33553106	SENTA	16	4017807685831
423310232	MONZA	6	4017807691092	R33553142	SENTA	16	4017807697858
438560142	TAGUS	58	4017807686852	R33553306	SENTA	16	4017807685824
438569142	TAGUS	59	4017807686869	R33553342	SENTA	16	4017807697834

Artikel-Nr. product no.	Serie series	Seite page	EAN-Nummer EAN-number	Artikel-Nr. product no.	Serie series	Seite page	EAN-Nummer EAN-number
R33555106	SENTA	17	4017807685855	R59711926	LUMA	36	4017807691399
R33555142	SENTA	17	4017807697872	R63071101	ROTUNDA	27	4017807682113
R36111026	LUCILLE	44	4017807637618	R63292106	MOVA	25	4017807682175
R36411032	TOVA	22	4017807682304	R63293106	MOVA	25	4017807682199
R36411076	TOVA	22	4017807682328	R63402132	ZARO	24	4017807685961
R36501042	TILOS	22	4017807682403	R63403132	ZARO	24	4017807682212
R36501043	TILOS	22	4017807690088	R63441032	VONO	25	4017807682236
R36501942	TILOS	22	4017807682434	R63481001	SANO	27	4017807682632
R36501943	TILOS	22	4017807690118	R64635101	UMBRIA V	26	4017807669404
R36521004	ELUNA	20	4017807682465	R64635901	UMBRIA V	26	4017807669428
R36521032	ELUNA	20	4017807682489	R64636101	UMBRIA VI	26	4017807669459
R36523004	ELUNA	20	4017807682526	R64636901	UMBRIA VI	26	4017807669473
R36523032	ELUNA	20	4017807682502	R64661901	MANDRIA II	26	4017807640335
R36601013	LIORA	21	4017807682380	R64664101	MANDRIA IV	26	4017807669756
R36601054	LIORA	21	4017807682366	R66742032	PARDINA	18	4017807693072
R36693032	BANO	45	4017807673364	R66791032	LAURIS	40	4017807678116
R36731036	KIBITO	44	4017807673395	R66831001	SIDERA	21	4017807697247
R36741032	PARDINA	18	4017807693096	R66831013	SIDERA	21	4017807697261
R36761013	ABELLA	20	4017807682021	R74771532	CHAIN	71	4017807697612
R36761052	ABELLA	20	4017807677706	R74938602	EMBER	71	4017807687767
R36771013	ELVEZIA	20	4017807677768	R80011032	MARS	30	4017807670455
R36771052	ELVEZIA	20	4017807682045	R80012032	MARS	30	4017807670479
R36791032	LAURIS	40	4017807678093	R80013932	MARS	30	4017807670493
R36791932	LAURIS	41	4017807678086	R80014032	MARS	30	4017807670516
R36841032	AMARILA	22	4017807682762	R86231732	JEROME	43	4017807637694
R36841065	AMARILA	22	4017807682755	R86232032	JEROME	43	4017807637700
R36841932	AMARILA	22	4017807682786	R86233032	JEROME	43	4017807637717
R36841965	AMARILA	22	4017807682779	R86491036	NATREL	44	4017807672312
R36861001	SIGNE	21	4017807686715	R86492036	NATREL	44	4017807672343
R36861901	SIGNE	21	4017807686739	R86531732	TRAVIA	31	4017807682588
R45853632	STICK	70	4017807697575	R86532032	TRAVIA	31	4017807682595
R45863632	SCOOP	70	4017807697599	R86533032	TRAVIA	31	4017807682601
R46741032	PARDINA	18	4017807693102	R86534032	TRAVIA	31	4017807682618
R46791032	LAURIS	40	4017807678109	R86651031	MERIDA	46	4017807670769
R46851031	TARYN	28	4017807685763	R86651032	MERIDA	46	4017807670783
R46851032	TARYN	28	4017807685756	R86661031	LYNAR	47	4017807670707
R46851065	TARYN	28	4017807685770	R86661032	LYNAR	47	4017807670684
R53121117	STAVRO	37	4017807686692	R86662031	LYNAR	47	4017807670745
R53491132	CIRRUS	34	4017807681161	R86662032	LYNAR	47	4017807670721
R53521132	MARTINI	34	4017807681185	R86663031	LYNAR	47	4017807672015
R53571187	APOLLO	35	4017807681208	R86663032	LYNAR	47	4017807671995
R53641187	HOLLY	35	4017807681123	R86671031	DELUME	45	4017807672213
R53651187	FAME	35	4017807681147	R86671032	DELUME	45	4017807672237
R56531001	HUMA	32	4017807682540	R86672031	DELUME	45	4017807672251
R56531002	HUMA	32	4017807682533	R86672032	DELUME	45	4017807672275
R56531012	HUMA	32	4017807682557	R86681035	LAMEGO	46	4017807670851
R56531091	HUMA	32	4017807682564	R86682035	LAMEGO	46	4017807670875
R56541079	LOVA	33	4017807682656	R86683335	LAMEGO	46	4017807672039
R56541089	LOVA	33	4017807682663	R86701032	YAKO	42	4017807670912
R56621002	GATIO	33	4017807682076	R86702032	YAKO	42	4017807670936
R56621079	GATIO	33	4017807682083	R86781731	CALVI	48	4017807678055
R56721002	CAPI	33	4017807685947	R86782031	CALVI	48	4017807678062
R56721079	CAPI	33	4017807685954	R86783031	CALVI	48	4017807678079
R56741032	PARDINA	18	4017807678321	R86851731	TARYN	29	4017807685527
R56751032	ZEBARA	18	4017807678345	R86851732	TARYN	29	4017807685510
R56791032	LAURIS	41	4017807678123	R86851765	TARYN	29	4017807685534
R56801015	FORMENTERA	49	4017807678130	R86852031	TARYN	28	4017807685565
R56801031	FORMENTERA	49	4017807680126	R86852032	TARYN	28	4017807685558
R56801039	FORMENTERA	49	4017807678147	R86852065	TARYN	28	4017807685572
R56801915	FORMENTERA	49	4017807692068	R86853031	TARYN	28	4017807685602
R56801931	FORMENTERA	49	4017807692105	R86853032	TARYN	28	4017807685596
R56801939	FORMENTERA	49	4017807692082	R86853065	TARYN	28	4017807685619
R56821002	QUINN	32	4017807682274	R86854031	TARYN	28	4017807685640
R56821015	QUINN	32	4017807682281	R86854032	TARYN	28	4017807685633
R56821040	QUINN	32	4017807682267	R86854065	TARYN	28	4017807685657
R56821076	QUINN	32	4017807682250	R86871042	PURUS	70	4017807687910
R56851031	TARYN	28	4017807685725	R908-1471	PASHA	36	4017807685978
R56851032	TARYN	28	4017807685718	R987-1471	TRESOR	36	4017807681376
R56851065	TARYN	28	4017807685732				
R57731193	SHELLY	37	4017807682014				
R59711126	LUMA	36	4017807691375				

Kontakte · Contact

Contact · Contact · Contactar · Contatto · Contact · Yhteydenotto · Kontakt

TRIO Leuchten GmbH

Gut Nierhof 17
D-59757 Arnsberg

T +49 (0) 2931 9666-0
F +49 (0) 2931 9666-57

info@trio-leuchten.de
www.trio-leuchten.de

Reality Leuchten GmbH

Gut Nierhof 17
D-59757 Arnsberg

T +49 (0) 2931 9666-99
F +49 (0) 2931 9666-98

info@reality-leuchten.de
www.reality-leuchten.de

TRIO International GmbH

Gut Nierhof 17
D-59757 Arnsberg

T +49 (0) 2931 9666-587
F +49 (0) 2931 9666-56

info@trio-lighting.com
www.trio-lighting.com

Baden Württemberg, Rheinland-Pfalz, Saarland

Antonio De Simone

T +49 (0) 151 5855222
antonio.desimone@trio-leuchten.de

Bayern, Hessen

Martin Kluge

T +49 (0) 171 7300330
martin.kluge@trio-leuchten.de

Berlin, Brandenburg, Mecklenburg-Vorpommern, Sachsen, Sachsen-Anhalt, Thüringen

Jörg Bumke

T +49 (0) 160 7406860
joerg.bumke@trio-leuchten.de

Bremen, Hamburg, Niedersachsen, Schleswig-Holstein

Jens Gebers

T +49 (0) 170 1615227
jens.gebers@trio-leuchten.de

Hessen, Nordrhein-Westfalen, Rheinland-Pfalz

Christian Teller

T +49 (0) 171 4521820
christian.teller@trio-leuchten.de

Österreich

Wolfgang Melich

T +43 (0) 660 5161228
wolfgang.melich@trio-leuchten.de

Schweiz

TRIO Leuchten GmbH

T +49 (0) 2931 9666-0
info@reality-leuchten.de



France

Stéphane Papierny

Directeur commercial France
info.france@trio-lighting.com

Julien Lamouret

Chef de Produits et Directeur
des Ventes France GSB

Sullivan Nicolas

Commercial pour les départements
01, 03, 07, 21, 23, 26, 38, 39, 42, 43, 48, 63,
69, 71, 73 et 74

Vincent Zaepffel

Commercial pour les départements
08, 10, 25, 51, 52, 54, 55, 57, 67, 68, 70,
88 et 90

Christophe Meulien

Agent commercial pour les départements
04, 05, 06, 11, 13, 30, 34, 66, 83, 84 et 98

Jean Barel

Agent commercial pour les départements
09, 12, 15, 16, 19, 24, 31, 32, 33, 40, 46, 47,
64, 65, 81, 82 et 87

Michel Salamand

Agent commercial pour les départements
14, 17, 22, 29, 35, 36, 37, 41, 44, 49, 50, 53, 56,
61, 72, 79, 85 et 86

Stéphane Riebel

Agent commercial pour les départements
18, 27, 28, 45, 58, 75, 76, 77, 78, 89, 91, 92, 93,
94 et 95

Sylvain Martin

Agent commercial pour les territoires
des DROM-COM

Agence Rouquié

Bruno Rouquié

Agent commercial GSB pour les départements
09, 12, 15, 16, 17, 18, 19, 24, 31, 32, 33, 36, 40, 46,
47, 64, 65, 81, 82 et 87

Jean Marc Beneforti

Agent commercial pour les départements
2a et 2b

Daho Bekhti

Agent commercial pour les départements
02, 59, 60, 62 et 80

Agence Nao West

Aymeric Monnet / Marie Lafleuriel

Agent commercial GSB pour les départements
14, 22, 29, 35, 37, 41, 44, 49, 50, 53, 56, 61, 72,
79, 85 et 86

Belgium / Luxemburg

**Yves Van den Berghe / Frank Boesmans /
Pauline Delorme / Wim Deplae**
info.belgium@trio-lighting.com

Denmark

Jan Rantzau-Bartens
info.denmark@trio-lighting.com

Netherlands

Karl Stok / Bas Martin
info.nederland@trio-lighting.com

Romania

Loredana Barbu
loredana.barbu@trio-lighting.com
T (+40) 741 788 674

Great Britain

TRIO Lighting UK Ltd.
Unit 5, Hemmells Park Hemmells,
Laindon Essex
SS1s 6GF
T +44 (0) 12 68 88 95 95
F +44 (0) 12 68 88 95 96
sales@trio-lightinguk.com

Italy

TRIO Lighting Italia s.r.l
Via Isonzo, 81
22066 Mariano Comense (CO)
T +39 (0) 317 477 55
F +39 (0) 313 551 560
commerciale@trio-lighting.com

Nordic and Baltic

TRIO Lighting Scandinavia Oy
Malmin raitti 17, rappu B
00700 Helsinki
T +358 (0) 10 23 13 390
TLS@trio-lighting.com

*Our Scandinavian organisation represents TRIO
in Finland, Sweden, Norway, Iceland, Estonia,
Latvia and Lithuania.*

Spain

TRIO Lighting Ibèrica S.L.
C/VALLESPÍR 19, Plta 2, módulo 1.1
08173 Sant Cugat del Vallès
T +34 (0) 935 458 630
info.iberica@trio-lighting.com

Africa

F&M Global
T (+32) 4719 22111
hans.deserranno@fmglobal.be

Ina Concept
T (+32) 4719 94693
jerome.freri@ina-concept.com

Albania

Kika Light
T (+355) 672 084 781
kikalight@gmail.com

Bosnia and Herzegovina

GRIČ d.o.o.
T (+38) 7039 706 658
daniel.martinovic@tel.net.ba

Bulgaria

ATG Bulgaria
T (+359) 899 927 707
deyana_petrova@atg-apa.net

Czech Republic

Luminex spol. s.r.o.
T (+42) 777 570 560
objednavky@luminex.cz

Greece / Cyprus

Solomon Lighting S.A.
T (+30) 21060 46003
alberto@solomongroup.gr

Hungary

Luxera Kft.
T (+36) 83 3163 88
info@trio-lampa.hu

Kosovo

ACN
T (+383) 44 344 434
info@acn-ks.com

North Macedonia

Elektro Megavat
T (+389) 71665006
contact@megalight.com.mk

Poland

Delighting Polska sp. z.o.o.
T (+48) 61 4367 481
kontakt@delighting.pl

Republic of Moldova

Volta LTD
T (+37) 322 26 7775
import5@volta.md

Serbia

Aura Light d.o.o. Novi Sad
T (+38) 121 2100724
aura.lightdoo@gmail.com

Slovakia

Feim SK s.r.o.
T (+42) 134 7743 228
svietidla@feim.sk

Slovenia

BT Trade d.o.o.
T (+386) 41 676 006
info@butiksvetil.si

Türkiye

Soho Aydınlatma Ticaret Ltd.
T (+90) 2165 7669 41
kartal.kendirici@soholight.com

Ukraine

MAX Light
T (+38) 4446 37942
tanya@maxlight.ua

SAVE THE DATE



LICHTWOCHE
SAUERLAND
01. – 05.03.2026

lichtforumnrw

Mitglied der Trägergesellschaft Lichtforum NRW e.V.
Member of the supporting organisation Lichtforum NRW e.V.

TRIO behält sich das Recht vor, zu jeder Zeit, notwendige Änderungen oder Aktualisierungen der in diesem Katalog enthaltenen Produkte vorzunehmen. · TRIO reserves the right to carry out any time, necessary changes or updates of the products in this catalogue. · TRIO se réserve le droit d'apporter à tout moment les modifications ou actualisations nécessaires aux produits dans ce catalogue. · TRIO behoudt zich het recht voor op ieder moment noodzakelijke wijzigingen of updates aan de producten in deze catalogus door te voeren. · TRIO se reserva , en todo momento, el derecho a realizar las modificaciones o actualizaciones que considere necesarias para cualquier producto de este catálogo. · TRIO si riserva il diritto di apportare, in qualunque momento, tutte le modifiche necessarie ai prodotti di questo catalogo. · TRIO-ul își rezervă dreptul de a face oricând orice modificări sau actualizări necesare pentru produsele din acest catalog. · TRIO pidättää oikeuden tehdä muutoksia tai päivittää tuotteita tässä luettelossa. · TRIO zastrzega sobie prawo do wprowadzania w dowolnym czasie zmian lub aktualizacji produktów zawartych w katalogu.

TRIO Leuchten GmbH

T +49 29319 666-0 · info@trio-leuchten.de

Reality Leuchten GmbH

T +49 2931 9666-99 · info@reality-leuchten.de

TRIO International GmbH

T +49 2931 9666-587 · info@trio-lighting.com

Gut Nierhof 17 · D-59757 Arnsberg · trio-lighting.com



/trioleuchten



@trio.lighting



@trioleuchten



@TRIO Lighting Group



@triolighting