

**RL**

live your light



VENTILATOREN | FANS

2026



TRONDHEIM 6



LILLESAND 7



BIDAR 8

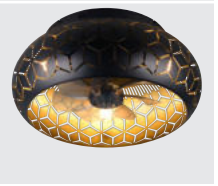

JOHANNA 9



SMILLUM 10



PAJALA 11



MUONIO 12



SKAULO 13



SORTLAND 14



STOCKHOLM 15



ROTSUND 16



MORA 17



STRALSUND 18



FARSUND 19

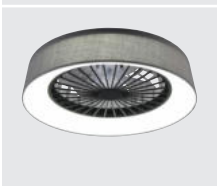

VISBY 20



HALMSTAD 21



HARSTAD 22



VARPULA 23

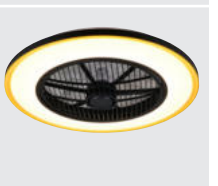

HOLMSUND 24



STRALSUND 25



SVAERHOLT 26

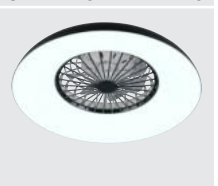

LINKÖPING 27

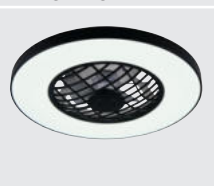

STOCKHOLM 28



KURULA 29



SAARELA 30



MOSS 31



TAMPERE 32



BORAS 33



KERAVA 34



KASFJORD 35



KIRUNA 36



VANSBRO 37



VOLDA 38



LUND 40



HAMMERFEST 41



RANDERS 42



HELSINKI 43



GÖTEBORG 44

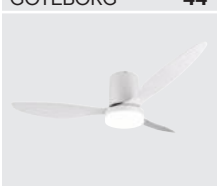

FLEN 45



OSLO 46



RENA 48

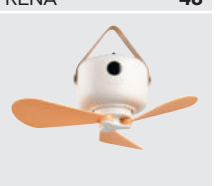

BREEZY 49



VIKING 50

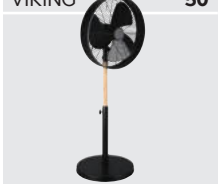

INHALT | CONTENT  
VENTILATOREN | FANS

# DC MOTOR

Deckenventilatoren mit DC-Motor (Gleichstrom-Elektromotor) sind sehr energiesparend und äußerst zuverlässig. Zudem laufen DC-Ventilatoren außerordentlich leise und sehr gleichmäßig. Sie eignen sich perfekt für Ruhebereiche, z. B. das Schlafzimmer, Kinderzimmer, Lesebereiche und Büros.

Ein weiterer Pluspunkt ist der Vor- und Rückwärtslauf bzw. Sommer- und Winterbetrieb. Im Sommer sollte der Deckenventilator gegen den Uhrzeigersinn gedreht werden, um den Luftstrom direkt nach unten zu leiten, der für eine kühle Brise sorgt. Im Winter muss der Ventilator im Uhrzeigersinn laufen, um einen Aufwind zu erzeugen und die warme Luft im Raum besser zu verteilen.

*Ceiling fans with a DC motor (direct current electric motor) are very energy-efficient and extremely reliable. DC fans also run extremely quietly and very smoothly. They are perfect for quiet areas, e.g. bedrooms, children's rooms, reading areas and offices.*

*Another plus point is the forward and reverse operation or summer and winter operation. In summer, the ceiling fan should be turned anticlockwise to direct the airflow straight downwards, which creates a cool breeze. In winter, the fan must run clockwise to create an updraft and better distribute the warm air in the room.*

## Sommerbetrieb | Summer operation



## Winterbetrieb | Winter operation

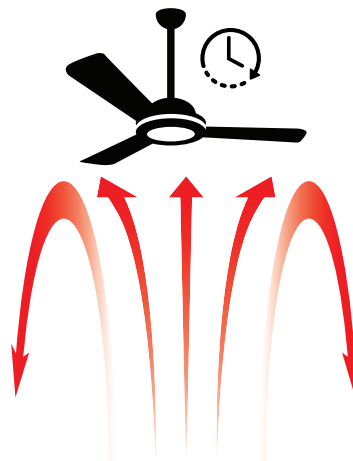

Vorteile DC-Ventilatoren  
Advantages of DC fans

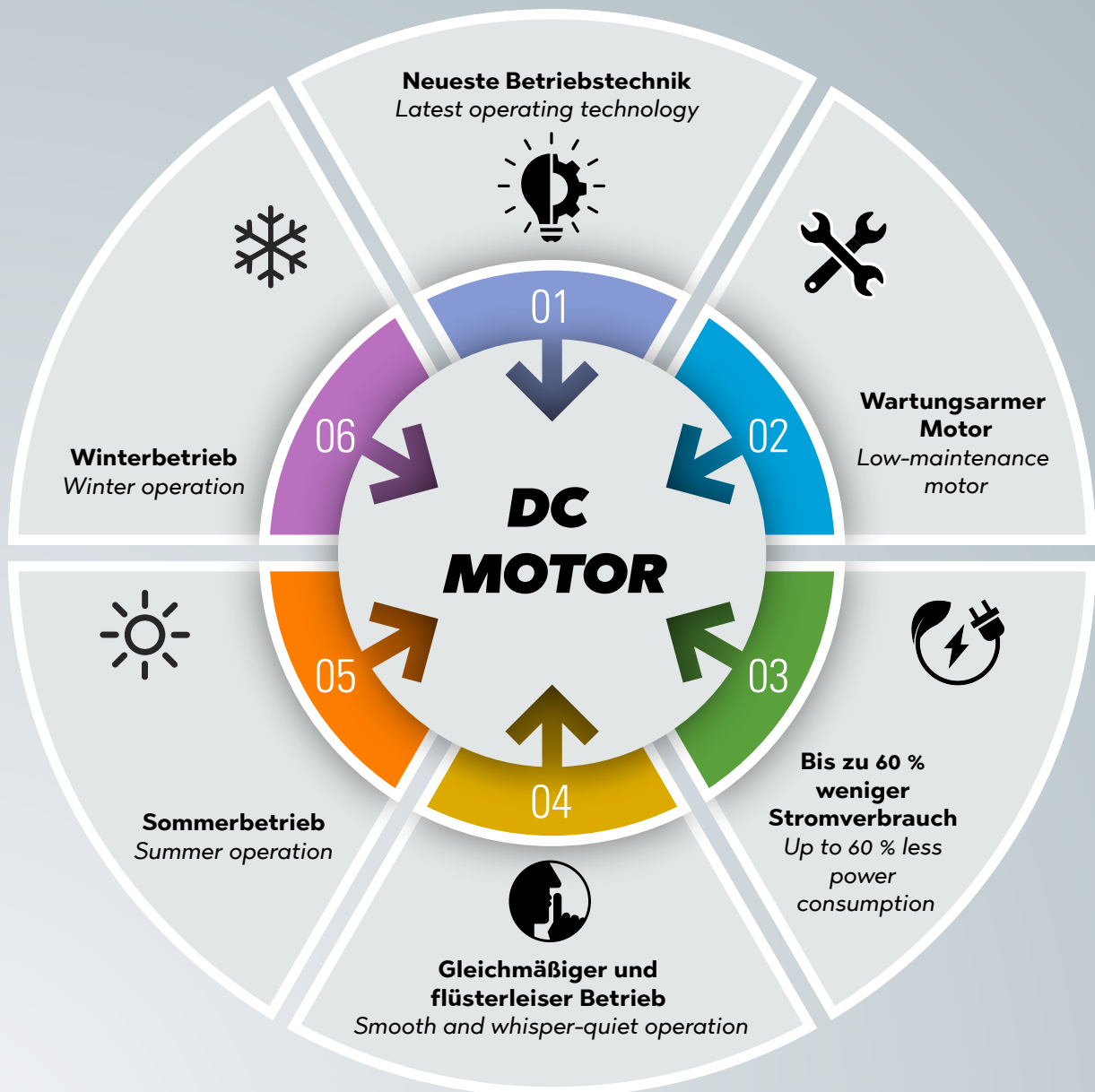

# TRONDHEIM



Level	1	2	3
Motor power consumption (W)	6	10	15
Airflow (m <sup>3</sup> /min)	26	34	39
RPM Rotations per minute	600	790	910
Service relationship (m <sup>3</sup> /min)/W	4,3	3,4	2,6
Sound level (db/A)	41	47	54
Maximum air speed (m/s)			4
Stand power	0,5		
Room size (m <sup>2</sup> )	<13		

**DC  
MOTOR**



SUMMER WINTER



R61095032



6



Artikelnummer   Art. No	R61095032	R61105032
Material   Material	Metall   Metal	Metall   Metal
	Kunststoff   Plastic	Kunststoff   Plastic
Farbe   Colour	Schwarz matt   Black mat	Schwarz matt   Black mat
	Schwarz   Black	Holzfarbig   Wood
Leuchtmittel   Lamps	excl. 4x E27 max. 10 W*	excl. 4x E27 max. 10 W*
Leuchtenlichtstrom   Luminous flux	470 lm	470 lm
Lichtfarbe   Light colour	2.700 K	2.700 K

\*Empfohlen/recommended: 987-400, Filament LED E27, 4 W, 470 lm, 2.700 K

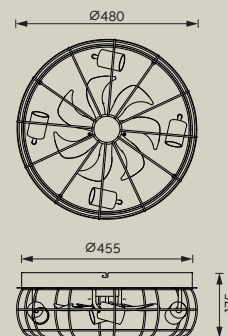

# LILLESAND



Level	1	2	3
Motor power consumption (W)	6	10	15
Airflow (m <sup>3</sup> /min)	26	34	39
RPM Rotations per minute	600	790	910
Service relationship (m <sup>3</sup> /min)/W	4,3	3,4	2,6
Sound level (db/A)	41	47	54
Maximum air speed (m/s)			4
Stand power	0,5		
Room size (m <sup>2</sup> )	<13		

**DC  
MOTOR**



Artikelnummer   Art. No	<b>R67302126</b>
Material   Material	Metall   Metal
	Papier   Paper
Farbe   Colour	Schwarz matt   Black mat
	Braun   Brown
Leuchtmittel   Lamps	excl. 4x E27, max. 10 W*
Leuchtenlichtstrom   Luminous flux	470 lm
Lichtfarbe   Light colour	3.000 K
*Empfohlen/recommended: <b>987-479</b> , Filament LED E27, 4 W, 470 lm, 3.000 K	

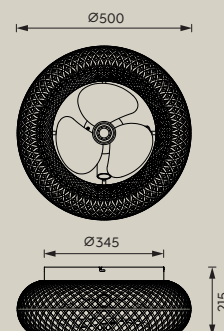

# BIDAR

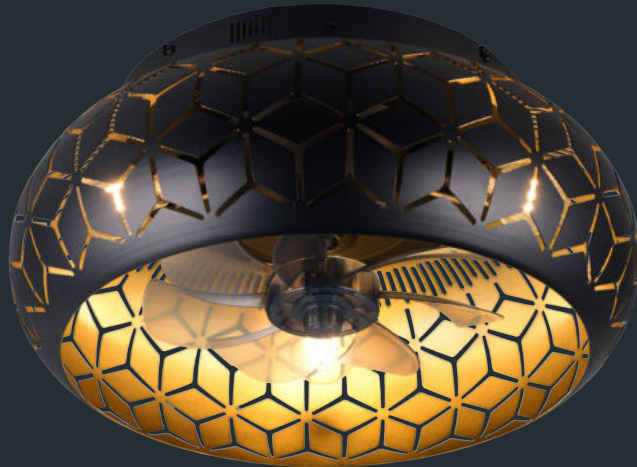

Level	1	2	3
Motor power consumption (W)	6	10	15
Airflow (m <sup>3</sup> /min)	26	34	39
RPM Rotations per minute	600	790	910
Service relationship (m <sup>3</sup> /min)/W	4,3	3,4	2,6
Sound level (db/A)	41	47	54
Maximum air speed (m/s)			3,9
Stand power	0,5		
Room size (m <sup>2</sup> )	<13		

**DC  
MOTOR**

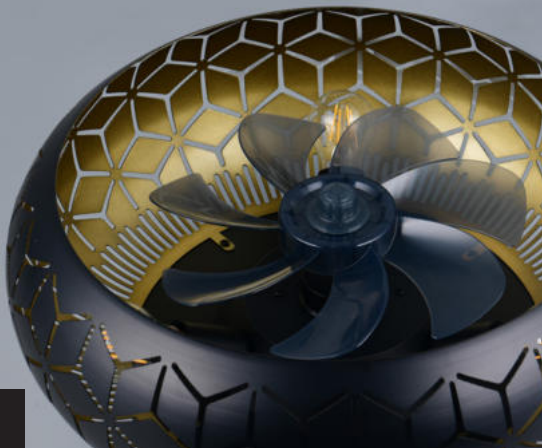
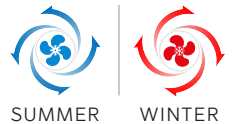

8



Artikelnummer   Art. No	R61574031	R61574080
Material   Material	Metall   Metal	Metall   Metal
Farbe   Colour	Weiß matt   White mat	Schwarz matt   Black mat
		Gold   Gold
Leuchtmittel   Lamps	excl. 3x E27*, max. 10 W	excl. 3x E27*, max. 10 W
Leuchtenlichtstrom   Luminous flux	470 lm	470 lm
Lichtfarbe   Light colour	2.700 K	2.700 K

Empfohlen/recommended: 987-400, Filament LED E27, 4 W, 470 lm, 2.700 K

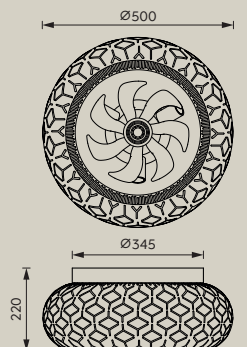

# JOHANNA



Level	1	2	3
Motor power consumption (W)	11	19	28
Airflow (m <sup>3</sup> /min)	35	47	55
RPM Rotations per minute	620	825	955
Service relationship (m <sup>3</sup> /min)/W	3,2	2,5	2
Sound level (db/A)	43	48	55
Maximum air speed (m/s)			5,2
Stand power	0,5		
Room size (m <sup>2</sup> )	<13		

**DC  
MOTOR**



Artikelnummer   Art. No	<b>R66884032</b>
Material   Material	Metall   Metal
Farbe   Colour	Schwarz matt   Black mat
Leuchtmittel   Lamps	excl. 4x E27*, max. 10 W
Leuchtenlichtstrom   Luminous flux	470 lm
Lichtfarbe   Light colour	2.700 K
Empfohlen/recommended: <b>987-400</b> , Filament LED E27, 4 W, 470 lm, 2.700 K	

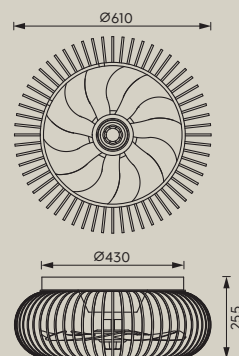

# SMILLUM



Level	1	2	3
Motor power consumption (W)	11	19	28
Airflow (m <sup>3</sup> /min)	36	48	57
RPM Rotations per minute	620	825	955
Service relationship (m <sup>3</sup> /min)/W	3,3	2,6	2,1
Sound level (db/A)	43	48	55
Maximum air speed (m/s)			5,2
Stand power	0,5		
Room size (m <sup>2</sup> )	<13		

**DC  
MOTOR**



SUMMER WINTER



10



Artikelnummer   Art. No	<b>R66905036</b>
Material   Material	Metall   Metal
	Hanf   Hemp material
Farbe   Colour	Schwarz matt   Black mat
	Naturbelassen   Natural
Leuchtmittel   Lamps	excl. 4x E27*, max. 10 W
Leuchtenlichtstrom   Luminous flux	470 lm
Lichtfarbe   Light colour	2.700 K
Empfohlen/recommended: <b>987-400</b> , Filament LED E27, 4 W, 470 lm, 2.700 K	

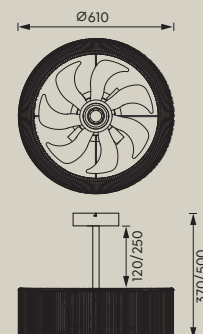

# PAJALA



Level	1	2	3
Motor power consumption (W)	6	10	12
Airflow (m <sup>3</sup> /min)	24	31	34
RPM Rotations per minute	620	825	955
Service relationship (m <sup>3</sup> /min)/W	4	3,1	2,8
Sound level (db/A)	40	45	53
Maximum air speed (m/s)			4,2
Stand power	0,5		
Room size (m <sup>2</sup> )	<13		

**DC  
MOTOR**



SUMMER WINTER



Lichtfarbe stufenlos einstellbar  
Light colour infinitely variable

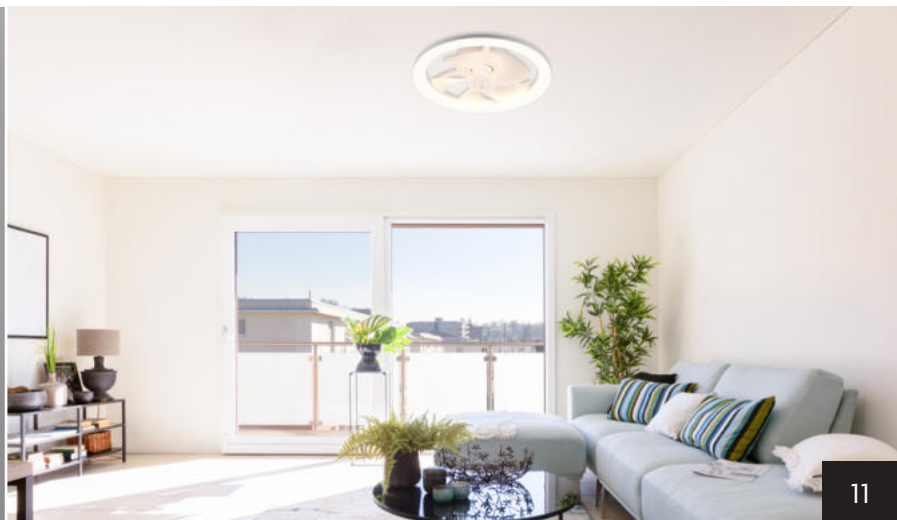

11



2.700 K 6.500 K

Artikelnummer   Art. No	<b>R69172131</b>
Material   Material	Kunststoff   Plastic
Farbe   Colour	Weiß matt   White mat
Leuchtmittel   Lamps	incl. SMD-LED, 22 W
Leuchtenlichtstrom   Luminous flux	2.600 lm
Lichtfarbe   Light colour	2.700 - 6.500 K

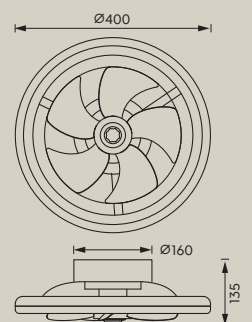

# MUONIO



Level	1	2	3
Motor power consumption (W)	5	10	15
Airflow (m <sup>3</sup> /min)	22	31	38
RPM Rotations per minute	800	1000	1200
Service relationship (m <sup>3</sup> /min)/W	4,4	3,1	2,5
Sound level (db/A)	40	45	49
Maximum air speed (m/s)			6,3
Stand power	0,48		
Room size (m <sup>2</sup> )	<13		

**DC  
MOTOR**



SUMMER

WINTER



Lichtfarbe stufenlos einstellbar  
Light colour infinitely variable



12



2.700 K  6.500 K

Artikelnummer   Art. No	<b>R69182132</b>
Material   Material	Metall   Metal
Farbe   Colour	Schwarz matt   Black mat
Leuchtmittel   Lamps	incl. SMD-LED, 20 W
Leuchtenlichtstrom   Luminous flux	2.300 lm
Lichtfarbe   Light colour	2.700 - 6.500 K

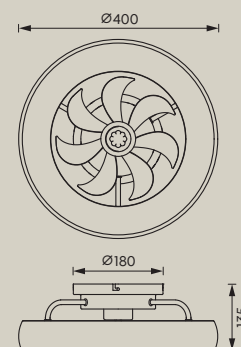

# SKAULO



Level	1	2	3
Motor power consumption (W)	5,8	10,1	15
Airflow (m <sup>3</sup> /min)	24	29	35
RPM Rotations per minute	620	825	955
Service relationship (m <sup>3</sup> /min)/W	4,1	2,9	2,3
Sound level (db/A)	40	45	53
Maximum air speed (m/s)			4,2
Stand power	0,5		
Room size (m <sup>2</sup> )	<13		

**DC  
MOTOR**

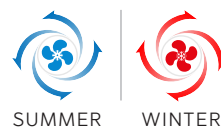

SUMMER

WINTER



Lichtfarbe stufenlos einstellbar  
Light colour infinitely variable

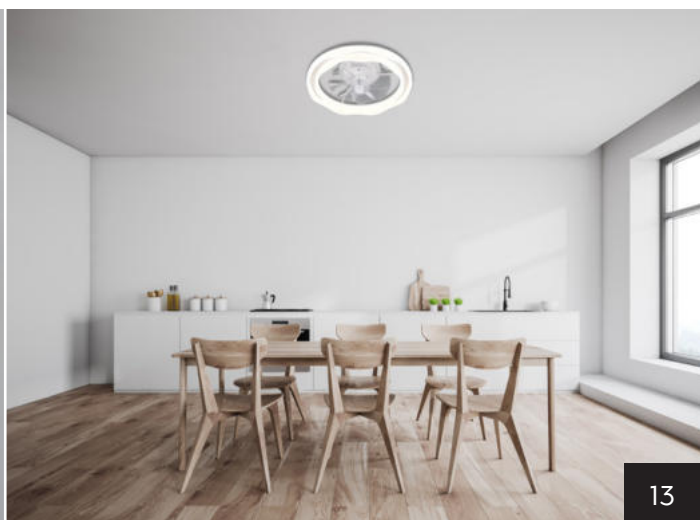

13



2.700 K  6.500 K

Artikelnummer   Art. No	<b>R69192131</b>
Material   Material	Kunststoff   Plastic
Farbe   Colour	Weiß   White
Leuchtmittel   Lamps	incl. SMD-LED, 35 W
Leuchtenlichtstrom   Luminous flux	4.200 lm
Lichtfarbe   Light colour	2.700 - 6.500 K

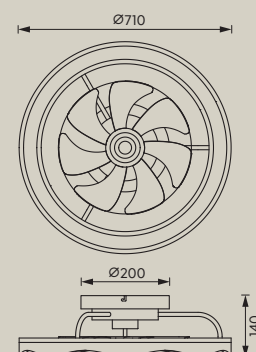

# SORTLAND

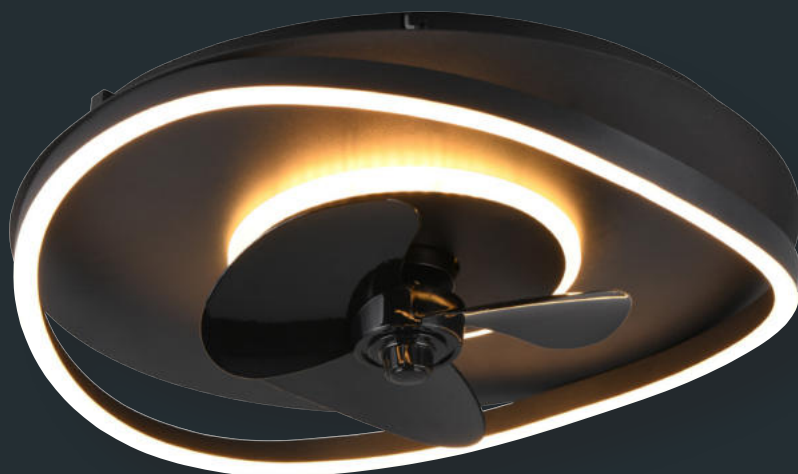

Level	1	2	3
Motor power consumption (W)	5	10	15
Airflow (m <sup>3</sup> /min)	19	27	33
RPM Rotations per minute	760	1040	1260
Service relationship (m <sup>3</sup> /min)/W	3,8	2,7	2,2
Sound level (db/A)	42	48	56
Maximum air speed (m/s)	0,9	1,5	1,8
Stand power	0,5		
Room size (m <sup>2</sup> )	<13		

**DC  
MOTOR**



14

Lichtfarbe stufenlos einstellbar / Light colour infinitely variable



2.700 K  6.500 K

Artikelnummer   Art. No	<b>R67393132</b>
Material   Material	Metall   Metal Kunststoff   Plastic
Farbe   Colour	Schwarz matt   Black mat
Leuchtmittel   Lamps	incl. SMD-LED, 30 W
Leuchtenlichtstrom   Luminous flux	3.500 lm
Lichtfarbe   Light colour	2.700 - 6.500 K

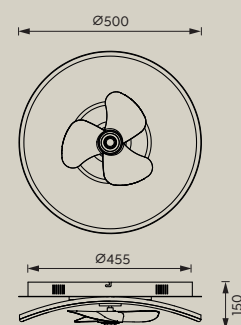

# STOCKHOLM



Level	1	2	3	4	5	6
Motor power consumption (W)	4	8	12	16	20	25
Airflow (m <sup>3</sup> /min)	42	58	70	76	81	88
RPM Rotations per minute	180	250	300	330	350	380
Service relationship (m <sup>3</sup> /min)/W	10,5	7,2	5,8	4,7	4	3,5
Sound level (db/A)	31	35	43	48	50,5	54
Maximum air speed (m/s)	1,4	1,72	2,04	2,36	2,68	3
Stand power	0,5					
Room size (m <sup>2</sup> )	<13					

DC  
MOTOR



SUMMER WINTER



Lichtfarbe stufenlos einstellbar  
Light colour infinitely variable



15



2.700 K 6.500 K

Artikelnummer   Art. No	R64262131	R64262132
Material   Material	Kunststoff   Plastic	Kunststoff   Plastic
Farbe   Colour	Weiß matt   White mat	Schwarz matt   Black mat
Leuchtmittel   Lamps	incl. SMD-LED, 37 W	incl. SMD-LED, 37 W
Leuchtenlichtstrom   Luminous flux	4.300 lm	4.300 lm
Lichtfarbe   Light colour	2.700 - 6.500 K	2.700 - 6.500 K

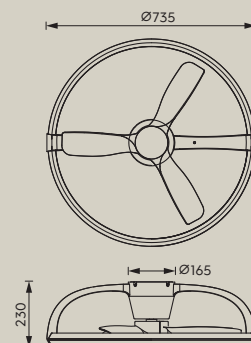

# ROTSUND



Level	1	2	3	4	5
Motor power consumption (W)	5	7,5	9,9	12,5	15
Airflow (m <sup>3</sup> /min)	13,5	16	19	22	26
RPM Rotations per minute	940	1090	1190	1300	1380
Service relationship (m <sup>3</sup> /min)/W	2,7	2,1	1,9	1,8	1,7
Sound level (db/A)	48	52	55	57	58
Maximum air speed (m/s)	3,3	3,7	4	4,5	4,8
Stand power	0,36				
Room size (m <sup>2</sup> )	<13				

DC  
MOTOR



Lichtfarbe stufenlos einstellbar  
Light colour infinitely variable

16



2.700 K  6.500 K

Artikelnummer   Art. No	R69222132
Material   Material	Kunststoff   Plastic
Farbe   Colour	Schwarz matt   Black mat
Leuchtmittel   Lamps	incl. SMD-LED, 22 W
Leuchtenlichtstrom   Luminous flux	3.000 lm
Lichtfarbe   Light colour	2.700 - 6.500 K

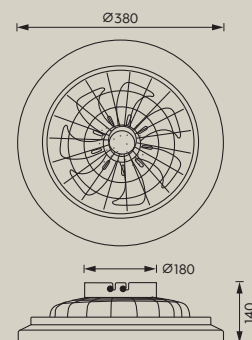

# MORA



Level	1	2	3
Motor power consumption (W)	6	9	12
Airflow (m <sup>3</sup> /min)	15	20	25
RPM Rotations per minute	520	680	850
Service relationship (m <sup>3</sup> /min)/W	2,5	2,2	2,1
Sound level (db/A)	35	43	52
Maximum air speed (m/s)			3,2
Stand power	0,5		
Room size (m <sup>2</sup> )	<13		

**DC  
MOTOR**



SUMMER



Lichtfarbe stufenlos einstellbar  
Light colour infinitely variable



17



2.700 K  6.000 K

Artikelnummer   Art. No	<b>R64032101</b>
Material   Material	Kunststoff   Plastic
Farbe   Colour	Weiß   White
Leuchtmittel   Lamps	incl. SMD-LED, 13 W
Leuchtenlichtstrom   Luminous flux	1.800 lm
Lichtfarbe   Light colour	2.700 - 6.000 K

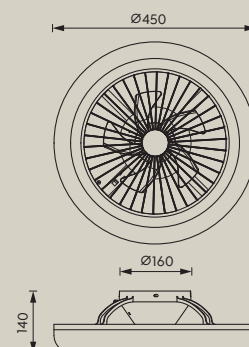

# STRALSUND



Level	1	2	3
Motor power consumption (W)	6	10	15
Airflow (m <sup>3</sup> /min)	25	29	33
RPM Rotations per minute	620	825	955
Service relationship (m <sup>3</sup> /min)/W	4,1	2,9	2,2
Sound level (db/A)	40	45	53
Maximum air speed (m/s)			3,5
Stand power	0,5		
Room size (m <sup>2</sup> )	<13		

DC  
MOTOR

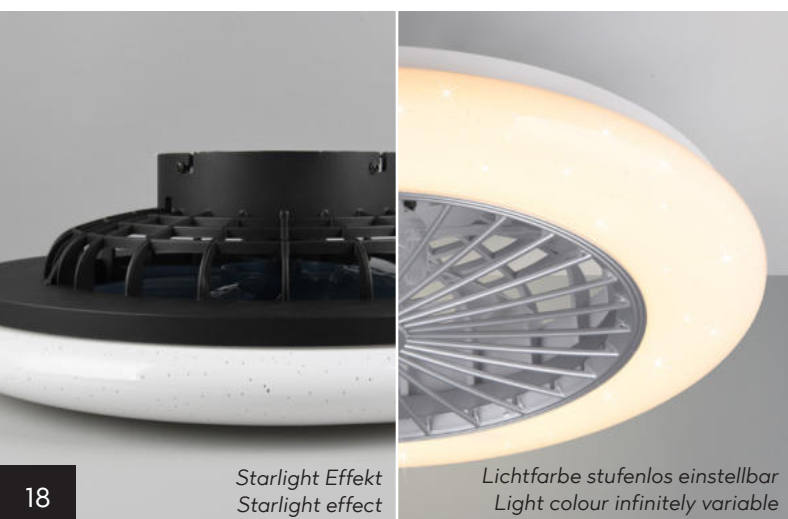

Starlight Effekt  
Starlight effect

Lichtfarbe stufenlos einstellbar  
Light colour infinitely variable



18



2.700 K  6.500 K

Artikelnummer   Art. No	R62522132	R62522187
Material   Material	Kunststoff   Plastic	Kunststoff   Plastic
Farbe   Colour	Weiß matt   White mat Schwarz matt   Black mat	Weiß matt   White mat Titanfarbig   Titan
Leuchtmittel   Lamps	incl. SMD-LED, 30 W	incl. SMD-LED, 30 W
Leuchtenlichtstrom   Luminous flux	3.500 lm	3.500 lm
Lichtfarbe   Light colour	2.700 - 6.500 K	2.700 - 6.500 K

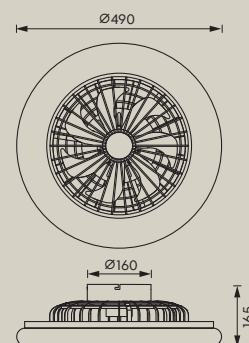

# FARSUND



Level	1	2	3
Motor power consumption (W)	6	10	15
Airflow (m <sup>3</sup> /min)	25	29	33
RPM Rotations per minute	620	825	955
Service relationship (m <sup>3</sup> /min)/W	4,1	2,9	2,2
Sound level (db/A)	40	45	53
Maximum air speed (m/s)			3,5
Stand power	0,5		
Room size (m <sup>2</sup> )	<13		

**DC  
MOTOR**

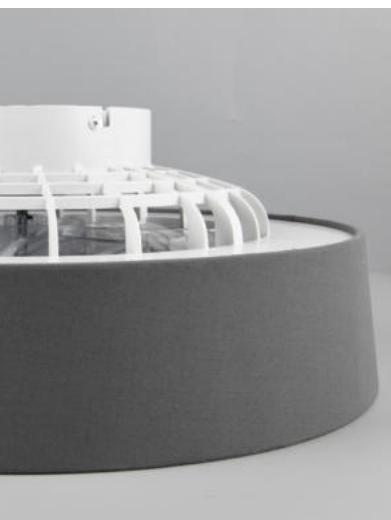

2.700 K  6.500 K

Artikelnummer   Art. No	<b>R62662111</b>
Material   Material	Stoff   Fabric Kunststoff   Plastic
Farbe   Colour	Grau   Grey Weiß   White
Leuchtmittel   Lamps	incl. SMD-LED, 30 W
Leuchtenlichtstrom   Luminous flux	3.500 lm
Lichtfarbe   Light colour	2.700 - 6.500 K

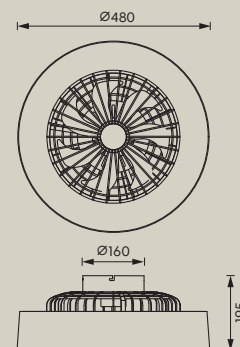

# VISBY



Level	1	2	3	4	5	6
Motor power consumption (W)	3	5	8	10,5	13	15
Airflow (m <sup>3</sup> /min)	15	23	29	33	36	39
RPM Rotations per minute	350	610	810	900	970	1050
Service relationship (m <sup>3</sup> /min)/W	5	4,6	3,6	3,1	2,8	2,6
Sound level (db/A)	31	35	42	48,5	52,5	55
Maximum air speed (m/s)						3,5
Stand power	0,5					
Room size (m <sup>2</sup> )	<13					

## DC MOTOR



2.700 K 6.500 K

Artikelnummer   Art. No	R62402106
Material   Material	Kunststoff   Plastic
	Chrom   Chrome
Farbe   Colour	Weiß   White
	Chrom   Chrome
Leuchtmittel   Lamps	incl. SMD-LED, 38 W
Leuchtenlichtstrom   Luminous flux	4.400 lm
Lichtfarbe   Light colour	2.700 - 6.500 K

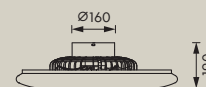

# HALMSTAD

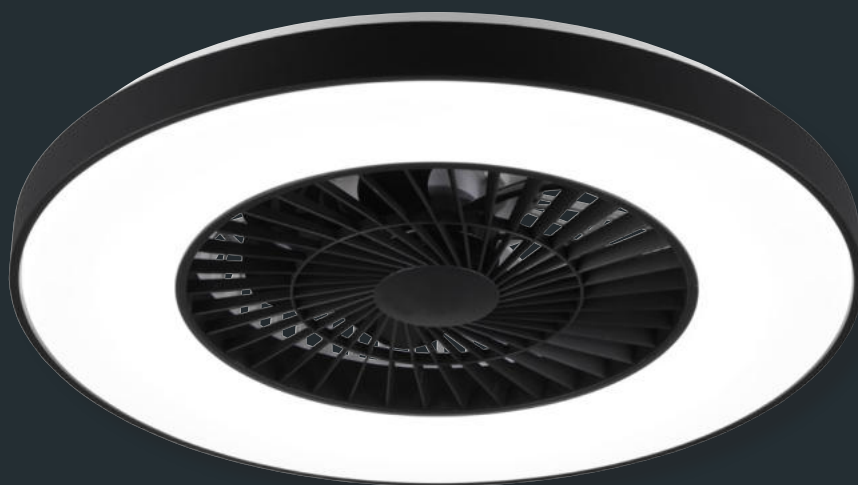

Level	1	2	3
Motor power consumption (W)	6	10	15
Airflow (m <sup>3</sup> /min)	25	29	33
RPM Rotations per minute	620	825	955
Service relationship (m <sup>3</sup> /min)/W	4,1	2,9	2,2
Sound level (db/A)	40	45	53
Maximum air speed (m/s)			3,5
Stand power	0,5		
Room size (m <sup>2</sup> )	<13		

**DC  
MOTOR**



2.700 K  6.500 K

Artikelnummer   Art. No	<b>R62672132</b>
Material   Material	Kunststoff   Plastic
Farbe   Colour	Schwarz matt   Black mat Weiß   White
Leuchtmittel   Lamps	incl. 1x SMD-LED, 38 W
Leuchtenlichtstrom   Luminous flux	4.400 lm
Lichtfarbe   Light colour	2.700 - 6.500 K

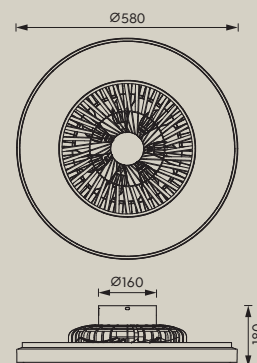

# HARSTAD



Level	1	2	3
Motor power consumption (W)	6	10	15
Airflow (m <sup>3</sup> /min)	25	29	33
RPM Rotations per minute	620	825	955
Service relationship (m <sup>3</sup> /min)/W	4,1	2,9	2,2
Sound level (db/A)	40	45	53
Maximum air speed (m/s)			3,5
Stand power	0,5		
Room size (m <sup>2</sup> )	<13		

**DC  
MOTOR**

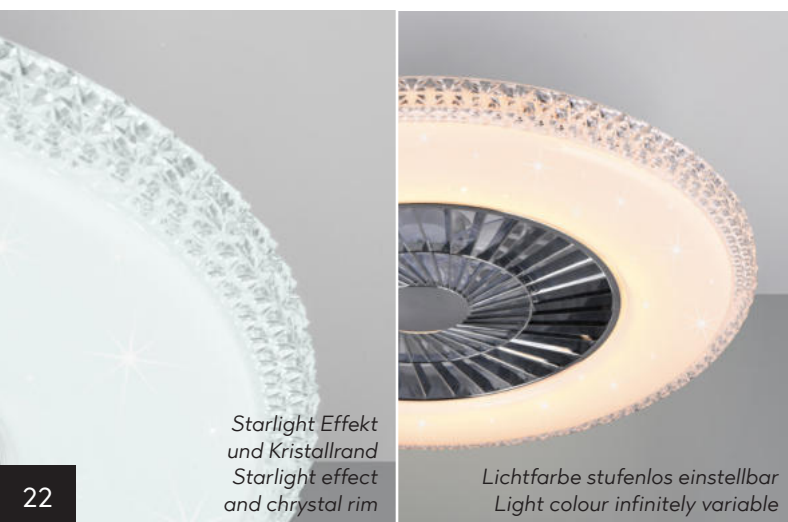

Starlight Effekt  
und Kristallrand  
Starlight effect  
and chrysal rim

Lichtfarbe stufenlos einstellbar  
Light colour infinitely variable



2.700 K  6.500 K

<b>Artikelnummer   Art. No</b>	<b>R62412106</b>
<b>Material   Material</b>	Kunststoff   Plastic Kristall   Crystal
<b>Farbe   Colour</b>	Weiß   White Transparent   Transparent
<b>Leuchtmittel   Lamps</b>	incl. 1x SMD-LED, 38 W
<b>Leuchtenlichtstrom   Luminous flux</b>	4.400 lm
<b>Lichtfarbe   Light colour</b>	2.700 - 6.500 K

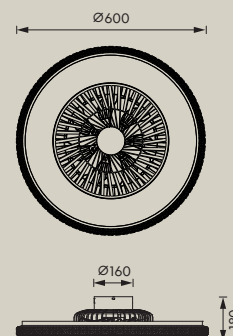

# VARPULA



Level	1	2	3	4	5	6
Motor power consumption (W)	1,5	4,5	8	11,3	14	15
Airflow (m <sup>3</sup> /min)	7	19	31	41	46	48
RPM Rotations per minute	160	600	800	950	1050	1100
Service relationship (m <sup>3</sup> /min)/W	4,7	4,2	3,9	3,6	3,3	3,2
Sound level (db/A)	32	34	38	43	49	55
Maximum air speed (m/s)	0,6	1,3	1,6	1,9	2,2	2,5
Stand power	0,5					
Room size (m <sup>2</sup> )	<13					

**DC  
MOTOR**

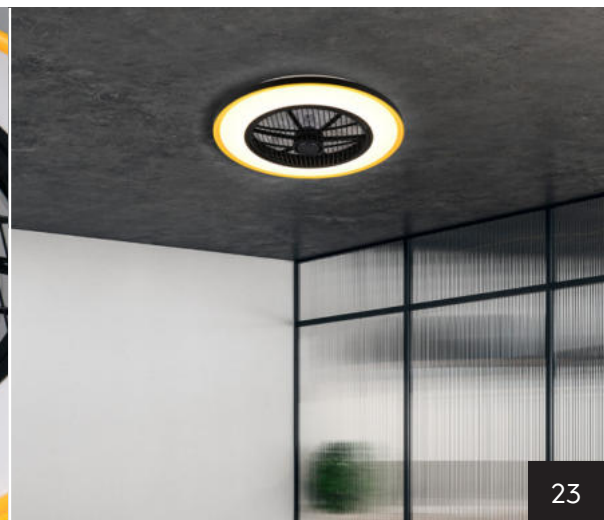
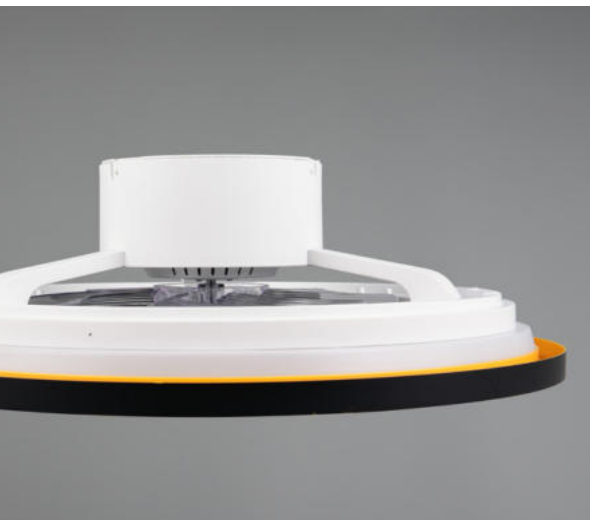

23



2.700 K  6.500 K

Artikelnummer   Art. No	<b>R69272180</b>
Material   Material	Kunststoff   Plastic
Farbe   Colour	Schwarz-Gold   Black Gold Weiß   White
Leuchtmittel   Lamps	incl. 1x SMD-LED, 28 W
Leuchtenlichtstrom   Luminous flux	3.200 lm
Lichtfarbe   Light colour	2.700 - 6.500 K

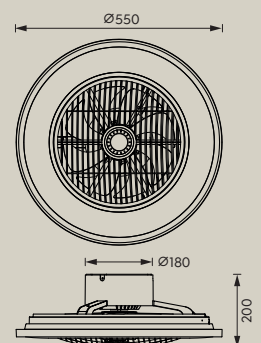

# HOLMSUND



Level	1	2	3
Motor power consumption (W)	5,5	10	13
Airflow (m <sup>3</sup> /min)	22	27	30
RPM Rotations per minute	685	915	990
Service relationship (m <sup>3</sup> /min)/W	4	2,8	2,4
Sound level (db/A)	41	45	50
Maximum air speed (m/s)			5
Stand power	0,5		
Room size (m <sup>2</sup> )	<13		

**DC  
MOTOR**



Lichtfarbe stufenlos einstellbar  
Light colour infinitely variable



Dynamic light:  
Faszinierende Lichteffekte  
Fascinating light effects



24



3.000 K  6.500 K

Artikelnummer   Art. No	<b>R69282101</b>
Material   Material	Kunststoff   Plastic
Farbe   Colour	Weiß   White
Leuchtmittel   Lamps	incl. 1x SMD-LED, 20 W
Leuchtenlichtstrom   Luminous flux	2.400 lm
Lichtfarbe   Light colour	3.000 - 6.500 K

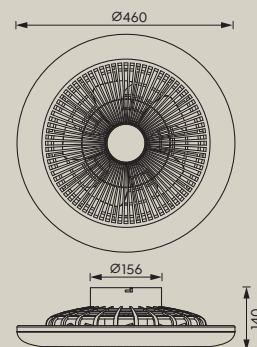

# STRALSUND



Level	1	2	3
Motor power consumption (W)	6	10	15
Airflow (m <sup>3</sup> /min)	25	29	33
RPM Rotations per minute	620	825	955
Service relationship (m <sup>3</sup> /min)/W	4,1	2,9	2,2
Sound level (db/A)	40	45	53
Maximum air speed (m/s)			3,5
Stand power	0,5		
Room size (m <sup>2</sup> )	<13		

**DC  
MOTOR**

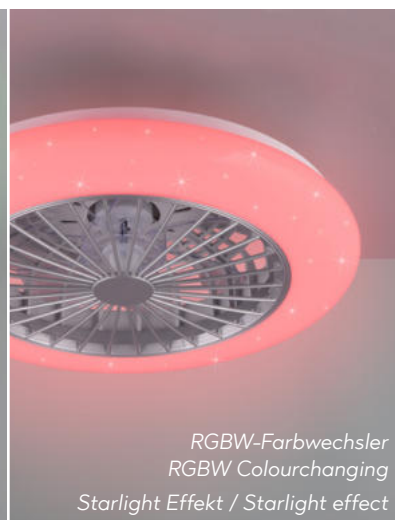
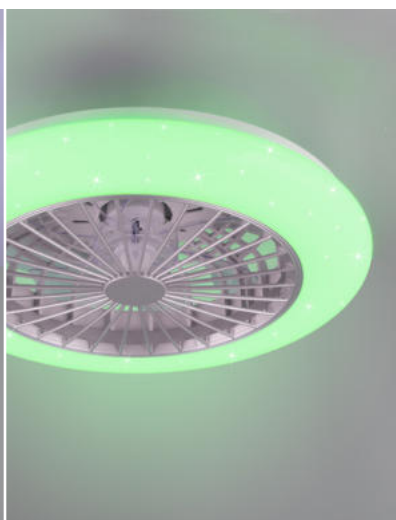
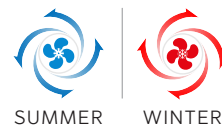

RGBW-Farbwechsler  
RGBW Colourchanging  
Starlight Effekt / Starlight effect



25



2.700 K  6.500 K

Artikelnummer   Art. No	<b>R62522987</b>
Material   Material	Kunststoff   Plastic
Farbe   Colour	Weiß matt   White mat Titanfarbig   Titan
Leuchtmittel   Lamps	incl. 1x SMD-LED, 30 W
Leuchtenlichtstrom   Luminous flux	3.500 lm
Lichtfarbe   Light colour	2.700 - 6.500 K

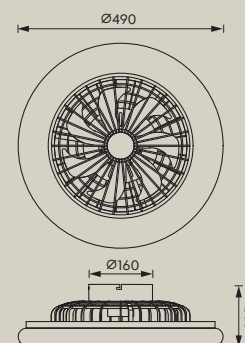

# SVAERHOLT



Level	1	2	3	4	5
Motor power consumption (W)	5	8,5	11,5	15	19
Airflow (m <sup>3</sup> /min)	26	31	35	39	45
RPM Rotations per minute	640	800	900	1000	1080
Service relationship (m <sup>3</sup> /min)/W	5,2	3,6	3	2,6	2,4
Sound level (db/A)	43	48	52	54	56
Maximum air speed (m/s)	2	2,5	3	3,5	4
Stand power	0,36				
Room size (m <sup>2</sup> )	<13				

**DC  
MOTOR**

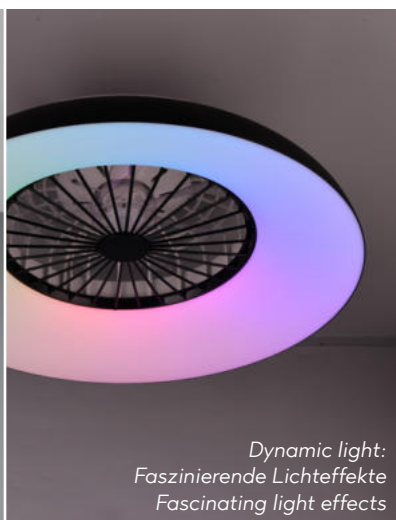

26



2.700 K  6.500 K

Artikelnummer   Art. No	<b>R69302102</b>
Material   Material	Kunststoff   Plastic
Farbe   Colour	Schwarz   Black
Leuchtmittel   Lamps	incl. 1x SMD-LED, 34 W
Leuchtenlichtstrom   Luminous flux	4.500 lm
Lichtfarbe   Light colour	2.700 - 6.500 K

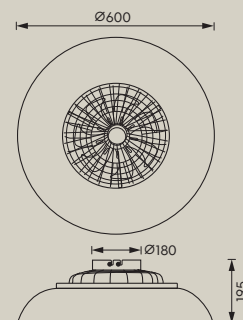

# LINKÖPING



Level	1	2	3
Motor power consumption (W)	6	15	20
Airflow (m <sup>3</sup> /min)	21	30	35
RPM Rotations per minute	650	820	1050
Service relationship (m <sup>3</sup> /min)/W	3,5	2,1	1,8
Sound level (db/A)	39	46	54
Maximum air speed (m/s)			3,8
Stand power	0,5		
Room size (m <sup>2</sup> )	<13		

**DC  
MOTOR**

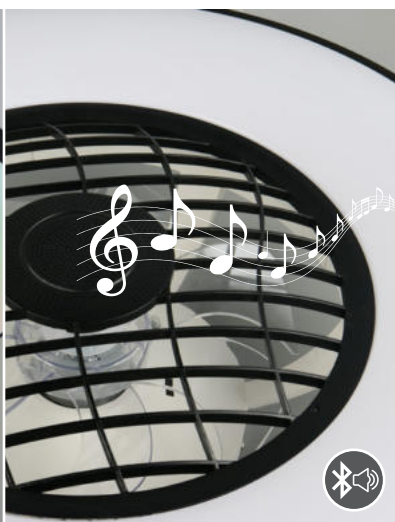

Dynamic light:  
Faszinierende Lichteffekte  
Fascinating light effects



2.700 K  6.500 K

Artikelnummer   Art. No	R64462102
Material   Material	Kunststoff   Plastic
Farbe   Colour	Schwarz   Black Weiß   White
Leuchtmittel   Lamps	incl. SMD-LED, 45 W
Leuchtenlichtstrom   Luminous flux	5.600 lm
Lichtfarbe   Light colour	2.700 - 6.500 K

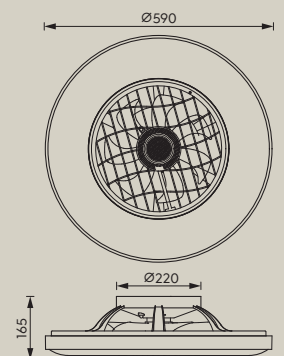

# STOCKHOLM



Level	1	2	3	4	5	6
Motor power consumption (W)	4	8	12	16	20	25
Airflow (m <sup>3</sup> /min)	42	58	70	76	81	88
RPM Rotations per minute	180	250	300	330	350	380
Service relationship (m <sup>3</sup> /min)/W	10,5	7,2	5,8	4,7	4	3,5
Sound level (db/A)	31	35	43	48	50,5	54
Maximum air speed (m/s)	1,4	1,72	2,04	2,36	2,68	3
Stand power	0,5					
Room size (m <sup>2</sup> )	<13					

DC  
MOTOR



SUMMER

WINTER



28

Lichtfarbe stufenlos einstellbar  
Light colour infinitely variable

Dynamic light:  
Faszinierende Lichteffekte  
Fascinating light effects



2.700 K 6.500 K

Artikelnummer   Art. No	R64262932
Material   Material	Kunststoff   Plastic
Farbe   Colour	Schwarz matt   Black mat
Leuchtmittel   Lamps	incl. SMD-LED, 37 W
Leuchtenlichtstrom   Luminous flux	4.500 lm
Lichtfarbe   Light colour	2.700 - 6.500 K

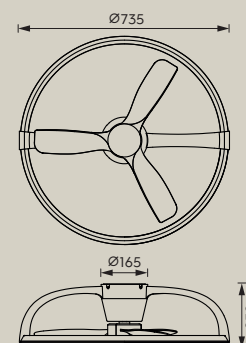

# KURULA



Level	1	2	3	4	5	6
Motor power consumption (W)	1,5	4	7	10,5	13	15
Airflow (m <sup>3</sup> /min)	10,5	24	33	37	41	43
RPM Rotations per minute	160	610	810	950	1050	1100
Service relationship (m <sup>3</sup> /min)/W	7	6	4,8	3,5	3,1	2,9
Sound level (db/A)	31	35	40,5	48,5	52,5	55
Maximum air speed (m/s)	0,9	1,5	2,1	2,5	2,9	3,2
Stand power	0,5					
Room size (m <sup>2</sup> )	<13					

**DC  
MOTOR**



Oszillierend  
Oscillating



Lichtfarbe stufenlos einstellbar  
Light colour infinitely variable



Fernbedienung inkl. Halterung  
Remote control including wall mount



2.700 K  6.500 K

Artikelnummer   Art. No	<b>R69382101</b>
Material   Material	Kunststoff   Plastic
Farbe   Colour	Weiß   White
Leuchtmittel   Lamps	incl. SMD-LED, 37 W
Leuchtenlichtstrom   Luminous flux	4.300 lm
Lichtfarbe   Light colour	2.700 - 6.500 K

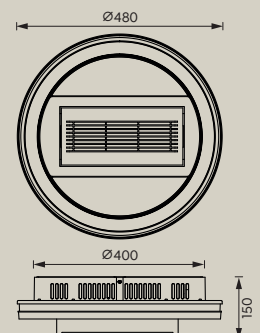

# SAARELA



Level	1	2	3	4	5	6
Motor power consumption (W)	8,4	9,5	10,5	12	13,7	15
Airflow (m <sup>3</sup> /min)	20	24	28	35	42	48
RPM Rotations per minute	550	585	605	645	675	705
Service relationship (m <sup>3</sup> /min)/W	2,4	2,5	2,7	2,9	3,1	3,2
Sound level (db/A)	40	41	42	43	45	48
Maximum air speed (m/s)	2	2,5	3,1	3,4	3,7	4
Stand power	0,5					
Room size (m <sup>2</sup> )	<13					

**DC  
MOTOR**



SUMMER

WINTER



Lichtfarbe einstellbar  
Light colour variable



30



3.000 K 4.000 K 6.500 K

Artikelnummer   Art. No	<b>R69472101</b>
Material   Material	Kunststoff   Plastic
Farbe   Colour	Schwarz matt   Black mat
Leuchtmittel   Lamps	incl. SMD-LED, 38 W
Leuchtenlichtstrom   Luminous flux	3.800 lm
Lichtfarbe   Light colour	3.000+4.000+6.500 K

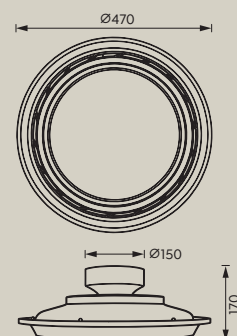

# MOSS



Level	1	2	3	4	5	6
Motor power consumption (W)	3,1	3,5	4,3	7,3	11,4	15
Airflow (m <sup>3</sup> /min)	27	30	35	52	68	79
RPM Rotations per minute	300	350	410	520	580	620
Service relationship (m <sup>3</sup> /min)/W	8,7	8,5	8,1	7,1	6	5,2
Sound level (db/A)	29	32	35	38	41	45
Maximum air speed (m/s)						3,1
Stand power	0,5					
Room size (m <sup>2</sup> )	<13					

**DC  
MOTOR**



SUMMER WINTER



Lichtfarbe stufenlos einstellbar  
Light colour infinitely variable



Flügel ein- und ausfahrbar  
Retractable/extendable fan blades



31



2.700 K 6.500 K

Artikelnummer   Art. No	<b>R69512101</b>
Material   Material	Kunststoff   Plastic
Farbe   Colour	Weiß   White
Leuchtmittel   Lamps	incl. SMD-LED, 18 W
Leuchtenlichtstrom   Luminous flux	2.520 lm
Lichtfarbe   Light colour	2.700 - 6.500 K

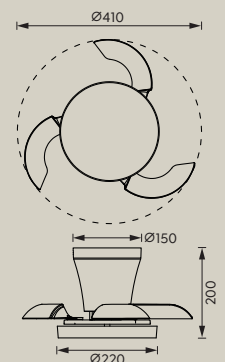

# TAMPERE



Level	1	2	3	4	5	6
Motor power consumption (W)	3,8	5,8	9,9	12,9	19,5	20
Airflow (m <sup>3</sup> /min)	32	45	59	69	92	95
RPM Rotations per minute	170	195	230	280	320	380
Service relationship (m <sup>3</sup> /min)/W	8,4	7,8	6	5,3	4,7	4,7
Sound level (db/A)	25	28	32	38	41	47
Maximum air speed (m/s)						2,8
Stand power	0,5					
Room size (m <sup>2</sup> )	<13					

**DC  
MOTOR**



Mit Wandhalterung  
With wall mount



Flügel ein- und ausfahrbar / Lichtfarbe einstellbar  
Retractable/extendable fan blades / Light colour variable



2.700 K  6.500 K

Artikelnummer   Art. No	<b>R69532101</b>
Material   Material	Kunststoff   Plastic
Farbe   Colour	Weiß   White
Leuchtmittel   Lamps	incl. SMD-LED, 24 W
Leuchtenlichtstrom   Luminous flux	2.800 lm
Lichtfarbe   Light colour	2.700 - 6.500 K

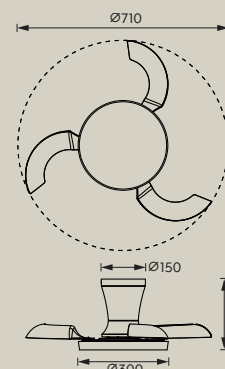

# BORAS



Level	1	2	3	4	5	6
Motor power consumption (W)	5,6	7,8	10	14	20	25
Airflow (m <sup>3</sup> /min)	32	42	50	68	92	105
RPM Rotations per minute	180	210	230	290	330	400
Service relationship (m <sup>3</sup> /min)/W	5,7	5,4	5	4,8	4,6	4,2
Sound level (db/A)	22	24	27	32	39	46
Maximum air speed (m/s)						2,9
Stand power	0,5					
Room size (m <sup>2</sup> )	13-20					

**DC  
MOTOR**



33



2.700 K  6.500 K

Artikelnummer   Art. No	<b>R69542131</b>
Material   Material	Kunststoff   Plastic
Farbe   Colour	Weiß matt   White mat
Leuchtmittel   Lamps	incl. SMD-LED, 24 W
Leuchtenlichtstrom   Luminous flux	2.640 lm
Lichtfarbe   Light colour	2.700 - 6.500 K

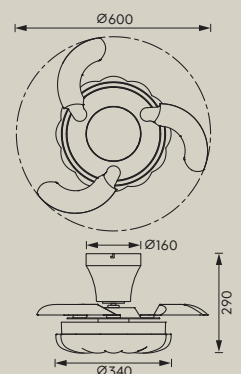

# KERAVA



Level	1	2	3	4	5	6
Motor power consumption (W)	9,8	11,8	15,4	18,9	22,8	30
Airflow (m <sup>3</sup> /min)	65	72	84	98	109	125
RPM Rotations per minute	188	200	215	226	234	248
Service relationship (m <sup>3</sup> /min)/W	6,6	6,1	5,5	5,2	4,8	4,2
Sound level (db/A)	28	31	37	41	45	49
Maximum air speed (m/s)						2,5
Stand power	0,5					
Room size (m <sup>2</sup> )	13-20					

**DC  
MOTOR**

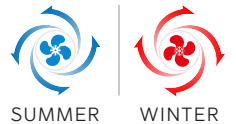

2.700 K  6.500 K

Artikelnummer   Art. No	<b>R69572101</b>
Material   Material	Kunststoff   Plastic
Farbe   Colour	Weiß   White
Leuchtmittel   Lamps	incl. SMD-LED, 30 W
Leuchtenlichtstrom   Luminous flux	3.500 lm
Lichtfarbe   Light colour	2.700 - 6.500 K

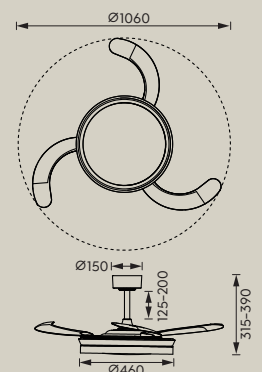

# KASFJORD



Level	1	2	3	4	5	6
Motor power consumption (W)	9,8	11,8	15,4	18,9	22,8	30
Airflow (m <sup>3</sup> /min)	65	72	84	98	109	125
RPM Rotations per minute	188	200	215	226	234	248
Service relationship (m <sup>3</sup> /min)/W	6,6	6,1	5,5	5,2	4,8	4,2
Sound level (db/A)	28	31	37	41	45	49
Maximum air speed (m/s)						2,5
Stand power	0,5					
Room size (m <sup>2</sup> )	13-20					

**DC  
MOTOR**

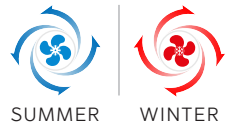

SUMMER WINTER



Flügel ein- und ausfahrbar  
Retractable/extensible fan blades



Lichtfarbe stufenlos einstellbar  
Light colour infinitely variable



35



2.700 K 6.500 K

Artikelnummer   Art. No	R64452131	R64452132
Material   Material	Metall   Metal	Metall   Metal
	Kunststoff   Plastic	Kunststoff   Plastic
Farbe   Colour	Weiß matt   White mat	Schwarz matt   Black mat
Leuchtmittel   Lamps	incl. SMD-LED, 34 W	incl. SMD-LED, 34 W
Leuchtenlichtstrom   Luminous flux	3.700 lm	3.700 lm
Lichtfarbe   Light colour	2.700 - 6.500 K	2.700 - 6.500 K

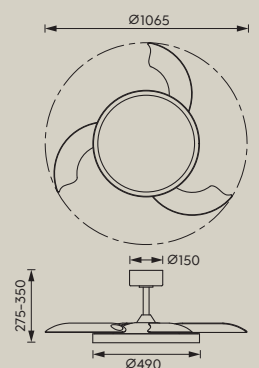

# KIRUNA



Level	1	2	3	4	5	6
Motor power consumption (W)	5,6	7,8	10	14	20	25
Airflow (m <sup>3</sup> /min)	40	50	59	75	104	120
RPM Rotations per minute	145	170	195	215	230	245
Service relationship (m <sup>3</sup> /min)/W	7,1	6,4	5,9	5,4	5,2	4,8
Sound level (db/A)	10,8	14,98	19,2	26,9	38,4	48
Maximum air speed (m/s)						2,4
Stand power	0,5					
Room size (m <sup>2</sup> )	13-20					

**DC  
MOTOR**

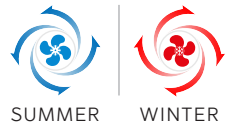

36 Starlight Effekt / Lichtfarbe stufenlos einstellbar  
Starlight effect / Light colour infinitely variable

Flügel ein- und ausfahrbar  
Retractable/extendable fan blades



2.700 K  6.500 K

Artikelnummer   Art. No	<b>R69622101</b>
Material   Material	Kunststoff   Plastic
Farbe   Colour	Weiß   White
Leuchtmittel   Lamps	incl. SMD-LED, 32 W
Leuchtenlichtstrom   Luminous flux	4.000 lm
Lichtfarbe   Light colour	2.700 - 6.500 K

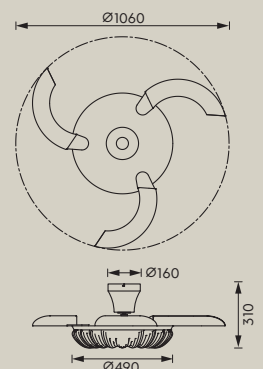

# VANSBRO



Level	1	2	3	4	5	6
Motor power consumption (W)	5,6	7,8	10	14	20	25
Airflow (m <sup>3</sup> /min)	40	50	59	75	104	120
RPM Rotations per minute	145	170	195	215	230	245
Service relationship (m <sup>3</sup> /min)/W	7,1	6,4	5,9	5,4	5,2	4,8
Sound level (db/A)	10,8	14,98	19,2	26,9	38,4	48
Maximum air speed (m/s)						2,9
Stand power	0,5					
Room size (m <sup>2</sup> )	13-20					

**DC  
MOTOR**



Lichtfarbe stufenlos einstellbar  
Light colour infinitely variable



Flügel ein- und ausfahrbar  
Retractable/extendable fan blades



37



2.700 K  6.500 K

Artikelnummer   Art. No	<b>R69652101</b>
Material   Material	Kunststoff   Plastic
Farbe   Colour	Weiß matt   White mat
Leuchtmittel   Lamps	incl. SMD-LED, 32 W
Leuchtenlichtstrom   Luminous flux	4.000 lm
Lichtfarbe   Light colour	2.700 - 6.500 K

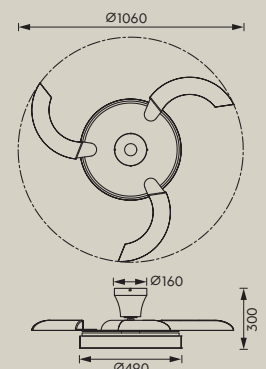

# VOLDA



Level	1	2	3	4	5	6
Motor power consumption (W)	9,8	11,8	15,4	18,9	22,8	30
Airflow (m <sup>3</sup> /min)	65	72	84	98	109	125
RPM Rotations per minute	188	200	215	226	234	248
Service relationship (m <sup>3</sup> /min)/W	6,6	6,1	5,5	5,2	4,8	4,2
Sound level (db/A)	28	31	37	41	45	50
Maximum air speed (m/s)						3,2
Stand power	0,5					
Room size (m <sup>2</sup> )	13-20					

**DC  
MOTOR**



Lichtfarbe stufenlos einstellbar  
Light colour infinitely variable



Flügel ein- und ausfahrbar  
Retractable/extendable fan blades



38



2.700 K  6.500 K

Artikelnummer   Art. No	R69642101	R69642107
Material   Material	Kunststoff   Plastic	Kunststoff   Plastic
Farbe   Colour	Weiß   White	Nickel matt   Nickel mat
Leuchtmittel   Lamps	incl. SMD-LED, 30 W	incl. SMD-LED, 30 W
Leuchtenlichtstrom   Luminous flux	3.500 lm	3.500 lm
Lichtfarbe   Light colour	2.700 - 6.500 K	2.700 - 6.500 K

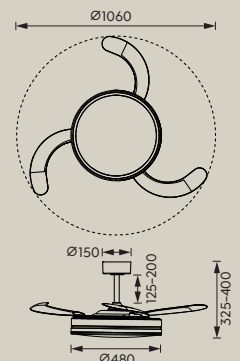



# LUND



Level	1	2	3
Motor power consumption (W)	6	9	12
Airflow (m <sup>3</sup> /min)	22	29	35
RPM Rotations per minute	210	320	450
Service relationship (m <sup>3</sup> /min)/W	3,6	3,2	2,9
Sound level (db/A)	35	39	45
Maximum air speed (m/s)			2,5
Stand power	0,4		
Room size (m <sup>2</sup> )	<13		

## DC MOTOR

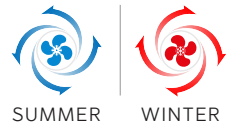

40 Lichtfarbe stufenlos einstellbar / Light colour infinitely variable



2.700 K 6.500 K

Artikelnummer   Art. No	R67462131	R67462132
Material   Material	Kunststoff   Plastic	Kunststoff   Plastic
Farbe   Colour	Weiß matt   White mat	Schwarz matt   Black mat
Leuchtmittel   Lamps	incl. SMD-LED, 8 W	incl. SMD-LED, 8 W
Leuchtenlichtstrom   Luminous flux	850 lm	850 lm
Lichtfarbe   Light colour	2.700 - 6.500 K	2.700 - 6.500 K

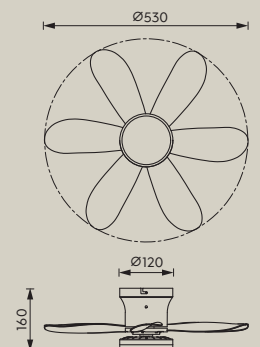

# HAMMERFEST



Level	1	2	3
Motor power consumption (W)	34	37	47
Airflow (m <sup>3</sup> /min)	26	57	75
RPM Rotations per minute	0,8	1,5	1,6
Service relationship (m <sup>3</sup> /min)/W	40	42	47
Sound level (db/A)	0,6	1,1	1,5
Maximum air speed (m/s)			3,9
Stand power	0		
Room size (m <sup>2</sup> )	<13		

AC  
MOTOR

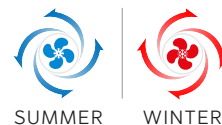

Lichtfarbe stufenlos einstellbar  
Light colour infinitely variable



Artikelnummer   Art. No	R66592031
Material   Material	Metall   Metal
Farbe   Colour	Weiß matt   White mat
Leuchtmittel   Lamps	excl. 1xE27 max. 60 W*
Leuchtenlichtstrom   Luminous flux	470 lm
Lichtfarbe   Light colour	2.700 K

\*Empfohlen/recommended: 987-400, Filament LED E27, 4 W, 470 lm, 2.700 K

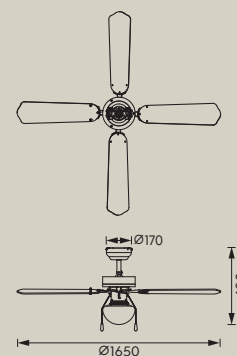

# RANDERS



Level	1	2	3	4	5	6
Motor power consumption (W)	4	6	9	12	18	29
Airflow (m <sup>3</sup> /min)	55	71	84	100	118	137
RPM Rotations per minute	135	168	193	221	253	292
Service relationship (m <sup>3</sup> /min)/W	13,7	11,8	9,3	8,3	6,5	4,8
Sound level (db/A)	32	36	41	45	50	55
Maximum air speed (m/s)						2,2
Stand power	0,4					
Room size (m <sup>2</sup> )	13-20					

**DC  
MOTOR**



SUMMER

WINTER



Lichtfarbe stufenlos einstellbar / Light colour infinitely variable



2.700 K 6.000 K

Artikelnummer   Art. No	R64412131	R64412132
Material   Material	Kunststoff   Plastic	Kunststoff   Plastic
Farbe   Colour	Weiß matt   White mat	Schwarz matt   Black mat
Leuchtmittel   Lamps	incl. SMD-LED, 20 W	incl. SMD-LED, 20 W
Leuchtenlichtstrom   Luminous flux	2.500 lm	2.500 lm
Lichtfarbe   Light colour	2.700 - 6.000 K	2.700 - 6.000 K

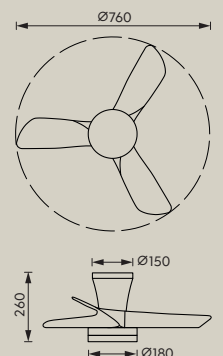

# HELSINKI



Level	1	2	3	4	5	6
Motor power consumption (W)	3,5	6	8	13	19	29
Airflow (m <sup>3</sup> /min)	63	81	97	120	133	146
RPM Rotations per minute	98	121	142	162	185	205
Service relationship (m <sup>3</sup> /min)/W	18	13,5	12	9,2	7	5
Sound level (db/A)	33	37	41	45	50	55
Maximum air speed (m/s)						2,1
Stand power	0,4					
Room size (m <sup>2</sup> )	13-20					

**DC  
MOTOR**



43



2.700 K  6.000 K

Artikelnummer   Art. No	R62732131	R62732132
Material   Material	Metall   Metal	Metall   Metal
	Kunststoff   Plastic	Kunststoff   Plastic
Farbe   Colour	Weiß matt   White mat	Schwarz matt   Black mat
Leuchtmittel   Lamps	incl. SMD-LED, 20 W	incl. SMD-LED, 20 W
Leuchtenlichtstrom   Luminous flux	2.500 lm	2.500 lm
Lichtfarbe   Light colour	2.700 - 6.000 K	2.700 - 6.000 K

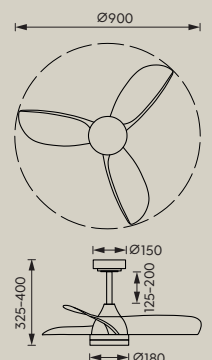

# GÖTEBORG



Level	1	2	3	4	5	6
Motor power consumption (W)	3,5	6	9	14	21	26
Airflow (m <sup>3</sup> /min)	78	108	137	162	181	199
RPM Rotations per minute	81	100	120	149	168	180
Service relationship (m <sup>3</sup> /min)/W	22	18	15	11,5	8,6	7,6
Sound level (db/A)	35	40	43	48	52	55
Maximum air speed (m/s)						1,9
Stand power	0,4					
Room size (m <sup>2</sup> )	>20					

**DC  
MOTOR**

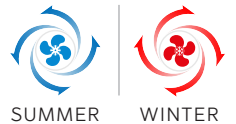

44

Lichtfarbe stufenlos einstellbar / Light colour infinitely variable



2.700 K  6.000 K

Artikelnummer   Art. No	R64202131	R64202132
Material   Material	Kunststoff   Plastic	Kunststoff   Plastic
Farbe   Colour	Weiß matt   White mat	Schwarz matt   Black mat
Leuchtmittel   Lamps	incl. SMD-LED, 20 W	incl. SMD-LED, 20 W
Leuchtenlichtstrom   Luminous flux	2.500 lm	2.500 lm
Lichtfarbe   Light colour	2.700 - 6.000 K	2.700 - 6.000 K

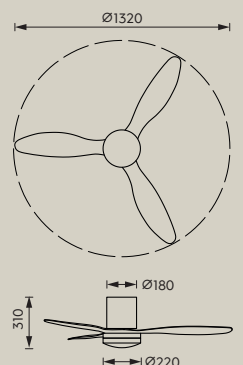

# FLEN



Level	1	2	3	4	5	6
Motor power consumption (W)	4	6	9	12	21,5	31
Airflow (m <sup>3</sup> /min)	52	69	89	105	149	175
RPM Rotations per minute	91	108	128	144	172	196
Service relationship (m <sup>3</sup> /min)/W	12,4	11,3	9,9	8,7	7	5,7
Sound level (db/A)	35	39	42	45	49	52
Maximum air speed (m/s)						2,8
Stand power	0,5					
Room size (m <sup>2</sup> )	>20					

**DC  
MOTOR**

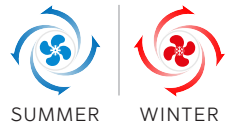

SUMMER WINTER



Lichtfarbe stufenlos einstellbar  
Light colour infinitely variable



45



2.700 K 6.000 K

Artikelnummer   Art. No	<b>R69682130</b>
Material   Material	Kunststoff   Plastic
Farbe   Colour	Weiß matt   White mat
Farbe   Colour	Holzfarbig   Wood coloured
Leuchtmittel   Lamps	incl. SMD-LED, 24 W
Leuchtenlichtstrom   Luminous flux	2.800 lm
Lichtfarbe   Light colour	2.700 - 6.000 K

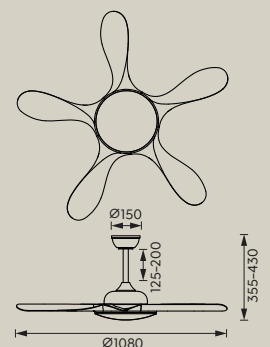

# OSLO



Level	1	2	3	4	5	6
Motor power consumption (W)	1,2	3,23	6,5	10	15	20
Airflow (m <sup>3</sup> /min)	11	27	43	49	55	62
RPM Rotations per minute	160	500	670	800	900	1000
Service relationship (m <sup>3</sup> /min)/W	9,2	8,3	6,6	4,9	3,7	3,1
Sound level (db/A)	31	39	46	53	57	59
Maximum air speed (m/s)	0,5	1,6	2,1	2,5	2,9	3,2
Stand power	0,5					
Room size (m <sup>2</sup> )	<13					

## DC MOTOR

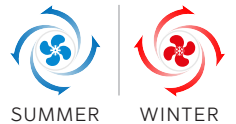

Lichtfarbe stufenlos einstellbar  
Light colour infinitely variable



Kabellänge 3000 mm  
Cable length 3000 mm



2.700 K  6.000 K

Artikelnummer   Art. No	R69692101	R69692102
Material   Material	Kunststoff   Plastic	Kunststoff   Plastic
Farbe   Colour	Weiß   White	Schwarz   Black
Leuchtmittel   Lamps	incl. SMD-LED, 20 W	incl. SMD-LED, 20 W
Leuchtenlichtstrom   Luminous flux	2.300 lm	2.300 lm
Lichtfarbe   Light colour	2.700 - 6.000 K	2.700 - 6.000 K

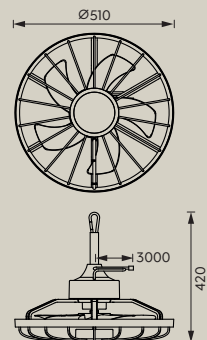



# RENA



Level	1	2	3	4
Motor power consumption (W)	1,05	1,44	1,8	2,5
Airflow (m <sup>3</sup> /min)	6,52	8,44	9,98	11
RPM Rotations per minute	750	820	880	970
Service relationship (m <sup>3</sup> /min)/W	6,21	5,86	5,54	4,4
Sound level (db/A)	25	28	30,3	34
Maximum air speed (m/s)	0,77	1	1,18	1,2
Stand power				
Room size (m <sup>2</sup> )				

5h 4,5-10h



48



Artikelnummer   Art. No	<b>R050-01</b>
Material   Material	Kunststoff   Plastic
Farbe   Colour	Weiß   White
	Holzfarbig   Wood coloured
Leuchtmittel   Lamps	incl. SMD-LED, 0,5 W
Leuchtenlichtstrom   Luminous flux	60 lm
Lichtfarbe   Light colour	4.000 K

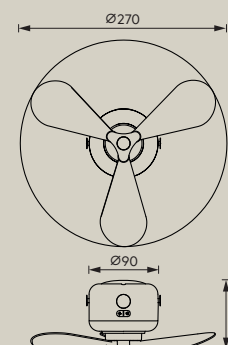

# BREEZY



Artikelnummer   Art. No	R044-01	R044-02	R044-49
Material   Material	Kunststoff   Plastic	Kunststoff   Plastic	Kunststoff   Plastic
Farbe   Colour	Weiß   White	Schwarz   Black	Pistaziengrün   Pistachio green
Leistung Motor   Power Engine	2 W	2 W	2 W
Volumenstrom   Volume flow	1,8 m <sup>3</sup> /min	1,8 m <sup>3</sup> /min	1,8 m <sup>3</sup> /min

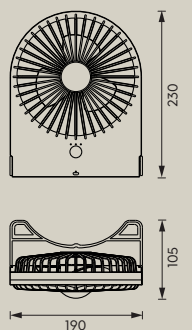

# VIKING



50



<b>Artikelnummer   Art. No</b>	<b>R034-32</b>
<b>Material   Material</b>	Metall   Metal
<b>Farbe   Colour</b>	Schwarz matt   Black mat Holzfarbig   Wood
<b>Leistung Motor   Power Engine</b>	50 W
<b>Volumenstrom   Volume flow</b>	64,91 m <sup>3</sup> /min

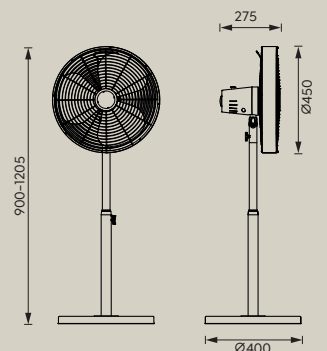

































# INDEX

Art-Nr. Art.-No.	EAN	Familie Family	DC	Seite Page	Art-Nr. Art.-No.	EAN	Familie Family	DC	Seite Page
R034-32	4017807456806	VIKING		50	R69622101	4017807689310	KIRUNA	✓	36
R044-01	4017807564464	BREEZY		49	R69642101	4017807689068	VOLDA	✓	38
R044-02	4017807564471	BREEZY		49	R69642107	4017807689075	VOLDA	✓	38
R044-49	4017807564495	BREEZY		49	R69652101	4017807689099	VANSBRO	✓	37
R050-01	4017807689228	RENA		48	R69682130	4017807689297	FLEN	✓	45
R61095032	4017807529562	TRONDHEIM	✓	6	R69692102	4017807689136	OSLO	✓	46
R61105032	4017807529586	TRONDHEIM	✓	6					
R61574031	4017807643978	BIDAR	✓	8					
R61574080	4017807643985	BIDAR	✓	8					
R62402106	4017807457766	VISBY	✓	20					
R62412106	4017807461206	HARSTAD	✓	22					
R62522132	4017807491098	STRALSUND	✓	18					
R62522187	4017807466157	STRALSUND	✓	18					
R62522987	4017807491128	STRALSUND	✓	25					
R62662111	4017807491081	FARSUND	✓	19					
R62672132	4017807491036	HALMSTAD	✓	21					
R62732131	4017807643947	HELSINKI	✓	43					
R62732132	4017807643954	HELSINKI	✓	43					
R64032101	4017807650419	MORA	✓	17					
R64202131	4017807643602	GÖTEBORG	✓	44					
R64202132	4017807643640	GÖTEBORG	✓	44					
R64262131	4017807644364	STOCKHOLM	✓	15					
R64262132	4017807644371	STOCKHOLM	✓	15					
R64262932	4017807693133	STOCKHOLM	✓	28					
R64412131	4017807643770	RANDERS	✓	42					
R64412132	4017807643787	RANDERS	✓	42					
R64452131	4017807644487	KASFJORD	✓	35					
R64452132	4017807693201	KASFJORD	✓	35					
R64462102	4017807644517	LINKÖPING	✓	27					
R66592031	4017807681734	HAMMERFEST	✓/AC	41					
R66884032	4017807688115	JOHANNA	✓	9					
R66905036	4017807688139	SMILLUM	✓	10					
R67302126	4017807605259	LILLESAND	✓	7					
R67393132	4017807606027	SORTLAND	✓	14					
R67462131	4017807643695	LUND	✓	40					
R67462132	4017807643732	LUND	✓	40					
R69172131	4017807688207	PAJALA	✓	11					
R69182132	4017807688221	MUONIO	✓	12					
R69192134	4017807688245	SKAULO	✓	13					
R69222132	4017807693164	ROTSUND	✓	16					
R69272180	4017807688597	VARPULA	✓	23					
R69282101	4017807688665	HOLMSUND	✓	24					
R69302102	4017807688795	SVAERHOLT	✓	26					
R69382101	4017807688825	KURULA	✓	29					
R69472101	4017807688917	SAARELA	✓	30					
R69512101	4017807688924	MOSS	✓	31					
R69532101	4017807688948	TAMPERE	✓	32					
R69542131	4017807690514	BORAS	✓	33					
R69572101	4017807688986	KERAVA	✓	34					

## PRODUKTEIGENSCHAFTEN | FEATURES

-  Getrennt schaltbar | Separately switchable
-  Schalter | Switch
-  Fernbedienung | Remote control
-  Integrierter Dimmer | Integrated dimmer
-  Lichtfarbe stufenlos einstellbar | Light colour infinitely variable
-  Nachtlicht | Night Light
-  Starlight Effekt | Starlight effect
-  Ventilator | Fan
-  3 Geschwindigkeitsstufen | 3 modes of speed
-  5 Geschwindigkeitsstufen | 5 modes of speed
-  6 Geschwindigkeitsstufen | 6 modes of speed
-  Timer | Timer
-  Sommer- und Winterbetrieb | Summer and winter operation
-  Memory Funktion | Memory function
-  RGBW Farbwechsler | RGBW Colourchanging
-  Oszillierend | Oscillating
-  Kippbar | Tilttable
-  Höhenverstellbar | Adjustable height
-  Ohne Leuchtmittel | Lamp(s) not included
-  Bluetooth Lautsprecher | Bluetooth loudspeaker
-  In der Höhe anpassbar | Adjustable in height
-  LED Switch Dimmer | LED Switch Dimmer
-  USB Anschluss | USB connection
-  Sleep timer | Sleep timer
-  Akkubetrieb | Rechargeable battery operated
-  Das Gerät verfügt über eine Heizleistungsstufe  
The unit has one heating power level
-  USB-C Anschluss | USB-C connection
-  4000 K | 4000 K
-  Dynamische Lichtsteuerung | Dynamic light control
-  Lichtfarbe einstellbar | Adjustable light colour
-  IP44
-  Zugschalter | Pull switch

### REALITY Leuchten GmbH

Gut Nierhof 17

D-59757 Arnsberg

T +49 2931 9666-99

F +49 2931 9666-98

info@reality-leuchten.com

www.reality-leuchten.com

#### DEUTSCHLAND

BADEN WÜRTTEMBERG,  
RHEINLAND-PFALZ UND SAARLAND

##### **Antonio De Simone**

T +49 (0) 151 5855222

antonio.desimone@trio-leuchten.de

BAYERN, HESSEN

##### **Martin Kluge**

T +49 (0) 171 7300330

martin.kluge@trio-leuchten.de

BERLIN, BRANDENBURG  
MECKLENBURG-VORPOMMERN,  
SACHSEN, SACHSEN-ANHALT,  
THÜRINGEN

##### **Jörg Bumke**

T +49 (0) 160 7406860

joerg.bumke@trio-leuchten.de

BREMEN, HAMBURG, NIEDERSACHSEN,  
SCHLESWIG-HOLSTEIN

##### **Jens Gebers**

T +49 (0) 170 1615227

jens.gebers@trio-leuchten.de

HESSEN, NORDRHEIN-WESTFALEN,  
RHEINLAND-PFALZ

##### **Christian Teller**

T +49 (0) 171 4521820

christian.teller@trio-leuchten.de

#### ÖSTERREICH

##### **Wolfgang Melich**

T +43 (0) 660 5161228

wolfgang.melich@trio-leuchten.de

#### SCHWEIZ

##### **TRIO Leuchten GmbH**

T +49(0)2931 9666 99

info@trio-leuchten.de



/trioleuchten



@trio.lighting



@trioleuchten



@TRIO Lighting Group



@trio Lighting



## **TRIO International GmbH**

Gut Nierhof 17  
D-59757 Arnsberg  
T +49 2931 9666-587  
F +49 2931 9666-56

info@trio-lighting.com  
www.trio-lighting.com

## **FRANCE**

### **Stéphane Papierny**

Directeur commercial France  
info.france@trio-lighting.com

### **Julien Lamouret**

Chef de Produits et Directeur des  
Ventes France GSB

### **Jean Barel**

Agent commercial pour les départements  
09, 12, 15, 16, 19, 24, 31, 32, 33, 40, 46,  
47, 64, 65, 81, 82 et 87

### **Daho Bekhti**

Agent commercial pour les départements  
02, 59, 60, 62 et 80

### **Jean Marc Beneforti**

Agent commercial pour les départements  
2a et 2b

### **Sylvain Martin**

Agent commercial pour les territoires  
des DROM-COM

### **Christophe Meulien**

Agent commercial pour les départements  
04, 05, 06, 11, 13, 30, 34, 66, 83, 84 et 98

### **Agence Nao West**

#### **Aymeric Monnet et Marie Lafleurriel**

Agent commercial GSB pour les  
départements 14, 22, 29, 35, 37, 41, 44,  
49, 50, 53, 56, 61, 72, 79, 85 et 86

### **Sullivan Nicolas**

Commercial pour les départements  
01, 03, 07, 21, 23, 26, 38, 39, 42,  
43, 48, 63, 69, 71, 73 et 74

### **Stéphane Riebel**

Agent commercial pour les départements  
18, 27, 28, 45, 58, 75, 76, 77, 78, 89, 91,  
92, 93, 94 et 95

### **Agence Rouquié – Bruno Rouquié**

Agent commercial GSB pour les départe-  
ments 09, 12, 15, 16, 17, 18, 19, 24, 31,  
32, 33, 36, 40, 46, 47, 64, 65, 81, 82 et 87

### **Michel Salamand**

Agent commercial pour les départements  
14, 17, 22, 29, 35, 36, 37, 41, 44, 49, 50,  
53, 56, 61, 72, 79, 85 et 86

### **Vincent Zaepffel**

Commercial pour les départements  
08, 10, 25, 51, 52, 54, 55, 57, 67,  
68, 70, 88 et 90

## **BELGIUM / LUXEMBURG**

**Yves Van den Berghe / Frank Boesmans /  
Pauline Delorme / Wim Deplae**  
info.belgium@trio-lighting.com

## **DENMARK**

**Jan Rantzau-Bartens**  
info.denmark@trio-lighting.com

## **NETHERLANDS**

**Karl Stok / Bas Martin**  
info.nederland@trio-lighting.com

## **ROMANIA**

**Loredana Barbu**  
T (+40) 741 788 674  
info.romania@trio-lighting.com

## **GREAT BRITAIN**

**TRIO Lighting UK Ltd.**  
Unit 5, Hemmells Park Hemmells,  
Laindon Essex  
SS1s 6GF  
T +44 (0) 12 68 88 95 95  
F +44 (0) 12 68 88 95 96  
sales@trio-lightinguk.com

## **ITALY**

**TRIO Lighting Italia s.r.l**  
Via Isonzo, 81  
22066 Mariano Comense (CO)  
T +39 (0) 317 477 55  
F +39 (0) 313 551 560  
commerciale@trio-lighting.com

## **NORDIC AND BALTIC**

**TRIO Lighting Scandinavia Oy**  
Malmin raitti, rappu 17 B  
00700 Helsinki  
T +358 (0) 10 23 13 390  
TLS@trio-lighting.com  
Our Scandinavian organisation represents TRIO also in  
Finland, Sweden, Norway, Iceland, Estonia, Latvia and  
Lithuania

## **SPAIN**

**TRIO Lighting Ibèrica S.L.**  
C/VALLESPIR 19, Plta 2, mòdulo 1.1  
08173 Sant Cugat del Vallès  
T +34 (0) 935 458 630  
info.iberica@trio-lighting.com

## **AFRICA**

**F&M Global**  
T (+32) 4719 22111  
hans.deserranno@fmglobal.be  
**Ina Concept**  
T (+32) 4719 94693  
jerome.freri@ina-concept.com

## **ALBANIA**

**Kika Light**  
T (+355) 672 084 781  
kika1light@gmail.com

## **BOSNIA AND HERZEGOVINA**

**GRIČ d.o.o.**  
T (+38) 7039 706 658  
daniel.martinovic@tel.net.ba

## **BULGARIA**

**ATG Bulgaria**  
T (+359) 899 927 707  
deyana\_petrova@atg-apa.net

## **CZECH REPUBLIC**

**Luminex spol. s.r.o.**  
T (+42) 777 570 560  
objednavky@luminex.cz

## **GREECE / CYPRUS**

**Solomon Lighting S.A.**  
T (+30) 21060 46003  
alberto@solomongroup.gr

## **HUNGARY**

**Luxera Kft.**  
T (+36) 83 3163 88  
info@trio-lampa.hu

## **KOSOVO**

**ACN**  
T (+383) 44 344 434  
info@acn-ks.com

## **NORTH MACEDONIA**

**Elektro Megavat**  
T (+389) 71665006  
contact@megalight.com.mk

## **POLAND**

**Delighting Polska sp. z.o.o.**  
T (+48) 61 4367 481  
kontakt@delighting.pl

## **REPUBLIC OF MOLDOVA**

**Volta LTD**  
T (+37) 322 26 7775  
import5@volta.md

## **SERBIA**

**Aura Light d.o.o. Novi Sad**  
T (+38) 121 2100724  
aura.lightdoo@gmail.com

## **SLOVAKIA**

**Feim SK s.r.o.**  
T (+42) 134 7743 228  
svietidla@feim.sk

## **SLOVENIA**

**BT Trade d.o.o.**  
T (+386) 41 676 006  
info@butiksvetil.si

## **TURKIYE**

**Soho Aydinlatma Ticaret Ltd.**  
T (+90) 2165 7669 41  
kartal.kendirci@soholight.com

## **UKRAINE**

**MAX Light**  
T (+38) 4446 37942  
tanya@maxlight.ua



**Reality Leuchten GmbH**

Gut Nierhof 17  
D-59757 Arnsberg  
T +49 2931 9666-99  
F +49 2931 9666-98  
[info@reality-leuchten.de](mailto:info@reality-leuchten.de)  
[www.reality-leuchten.de](http://www.reality-leuchten.de)

**TRIO International GmbH**

Gut Nierhof 17  
D-59757 Arnsberg  
T +49 2931 9666-587  
F +49 2931 9666-56  
[info@trio-lighting.com](mailto:info@trio-lighting.com)  
[www.trio-lighting.com](http://www.trio-lighting.com)

