

rabalux[®]

OUTDOOR LIGHTS

2026

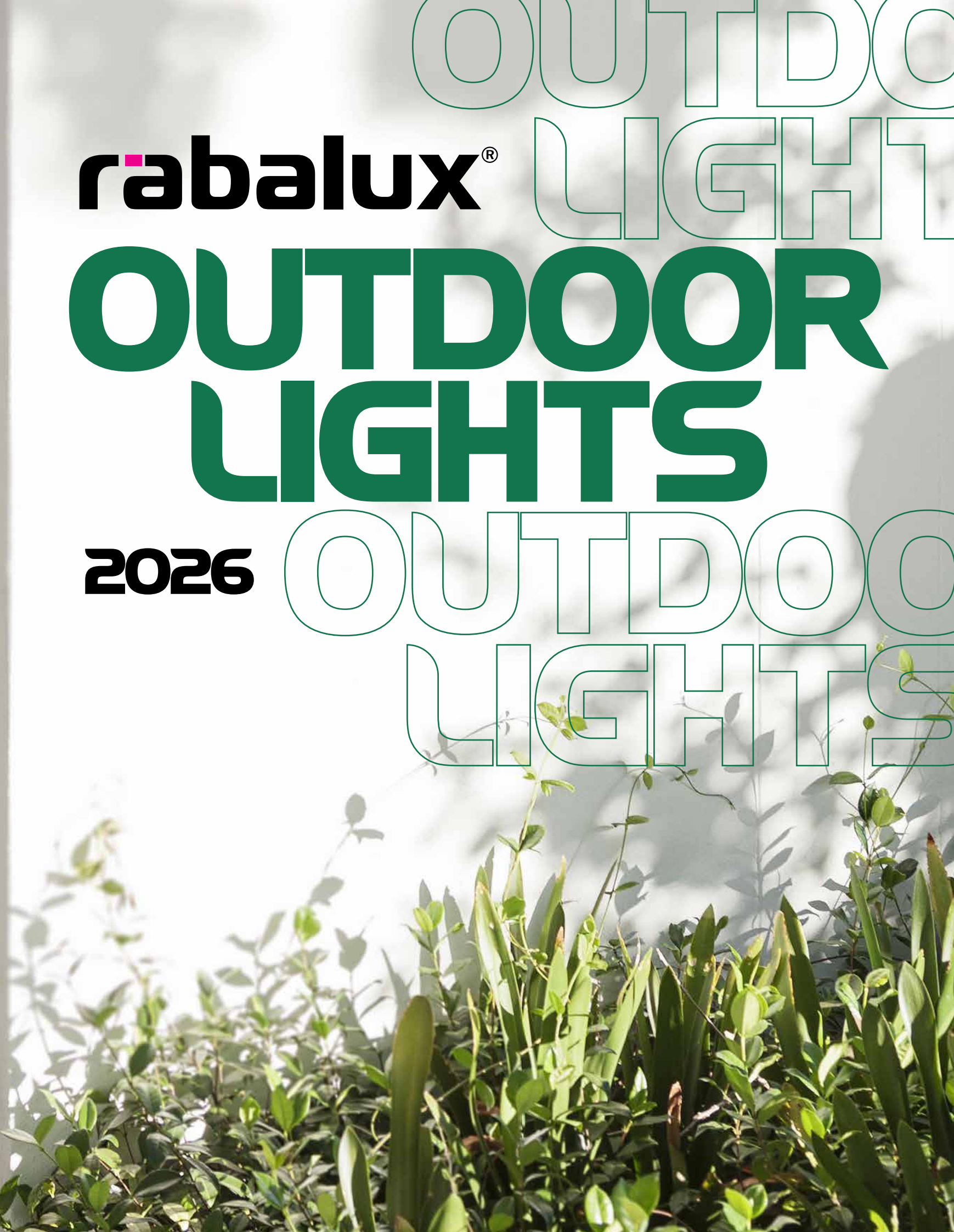

WELCOME • ÜDVÖZÖLJÜK • WILLKOMMEN

DEAR PARTNER AND CUSTOMER!



We believe that home doesn't end within four walls: your garden, terrace, balcony, or entrance deserves stylish, well-planned lighting just as much. Outdoor lighting is not only practical — it creates atmosphere, adds a sense of safety, and makes evening moments truly come alive.

We are delighted to present our new outdoor catalogue, where you can choose from our new modern, energy-efficient lights as well as our timeless classic favourites.

Get inspired and bring light to your own outdoor stories! Enjoy browsing!

KEDVES PARTNEREINK ÉS VÁSÁRLÓINK!



Hiszünk benne, hogy az otthon nem ér véget a négy falnál: a kert, a terasz, az erkély vagy a bejárat ugyanúgy megérdemli a stílusos, jól megtervezett fényt. A kültéri világítás nemcsak praktikus, hanem hangulatot teremt, biztonságot ad, és igazán élővé teszi az esti pillanatokat.

Örömmel mutatjuk be idei kültéri katalógusunkat, amelyben új modern, energiatakarékos lámpáink mellett időtálló klasszikus lámpáink között válogathatsz!

Inspirálódj, és teremts fényt a saját kinti történeteidhez! Kellemes böngészést kívánunk!

SEHR GEEHRTE PARTNER UND KUNDEN!



Wir sind überzeugt, dass das Zuhause nicht an den vier Wänden endet: Garten, Terrasse, Balkon oder Eingangsbereich verdienen ebenso stilvolles, gut geplantes Licht. Außenbeleuchtung ist nicht nur praktisch – sie schafft Atmosphäre, sorgt für Sicherheit und lässt die Abende wirklich lebendig werden.

Mit Freude präsentieren wir unseren diesjährigen Außenleuchtenkatalog, in dem du neben unseren neuen modernen, energieeffizienten Leuchten auch aus zeitlosen Klassikern wählen kannst.

Lass dich inspirieren und bring Licht in deine eigenen Outdoor-Geschichten! Viel Freude beim durchblättern!



CONTACT • ELÉRHETŐSÉGEK • KONTAKT

CENTRE/KÖZPONT/ZENTRALE



MAGYARORSZÁG/HUNGARY

RÁBALUX HEAD OFFICE
RÁBALUX VILÁGÍTÁSTECHNIKA ZRT.
VILÁGÍTÁSTECHNIKA GYÁRTÁS ÉS FORGALMAZÁS/
LIGHTING PRODUCTION AND DISTRIBUTION

H-9027 Győr, Körtefa u. 5.
Tel.: +36 96 526 716
E-mail: info@rabalux.com
www.rabalux.com

AFFILIATES/LEÁNYVÁLLALATOK/ZWEIGSTELLEN



BULGARIA

РАБАЛУКС ЕООД / RABALUX EOOD
ул. "Андрей Николов" №15,
1111 София,
България
Тел./Факс: +359 2 936 00 97
E-mail: infobg@rabalux.com
www.rabalux.bg



CROATIA, BOSNIA HERZEGOVINA, MONTENEGRO



RABALUX RASVJETA d.o.o.
Ulica grada Gospića 1a
10000 Zagreb
Tel.: +385 1 652 80 66
E-mail: infocro@rabalux.com
www.rabalux.hr



CZECH REPUBLIC

RABALUX CZ Svítidla s.r.o.
Kaštanová 141/a, 617 00 Brno,
Česká Republika
Tel.: +420 739 665 322
E-mail: infocz@rabalux.com
www.rabalux.cz



HUNGARY

Rábalux Magyarország Kft.
Magyarország
H-9027 Győr,
Körtefa u. 5.
Tel.: +36 96 526 716
E-mail: infohu@rabalux.com
www.rabalux.hu



POLAND

Rabalux Sp. z o.o.
ul. Sołtysia 119, 40-750 Katowice,
Polska
Tel.: +48 32 254 61 34
E-mail: infopl@rabalux.com
zamowienia@rabalux.com
www.rabalux.pl



ROMANIA

SC RABALUX SRL
Cluj-Napoca, str. Fabricii,
nr. 93-103, jud. CLUJ
Romania
cod postal: 400632
Tel.: +40 264 456 040
E-mail: infofo@rabalux.com
www.rabalux.ro



SERBIA, NORTHERN MACEDONIA



Rabalux SRB d.o.o.
Autoput za Zagreb 20,
11080 Beograd –
Zemun, Srbija
Mob: + 381 60 444 3977;
Tel.: +381(0)11 2013 986
E-mail: infosrb@rabalux.com
www.rabalux.rs



SLOVAKIA

RABALUX SK. Svetidlá, s.r.o.
Alžbetínske nám. 328,
929 01 Dunajská Streda,
Slovenská Republika
Tel.: +421 31 551 54 04
E-mail: infosk@rabalux.com
www.rabalux.sk



UKRAINE

ТОВ Рабалукс,
вул. Рилєєва 4, м. Ужгород,
Україна, 88017
моб.тел.: +38 067 310 05 20
E-mail: infoua@rabalux.com
www.rabalux.ua

OFFICIAL RESELLERS/MEGBÍZOTT VISZONTELAĐÓK/BEAUFTRAGTE WIEDERVERKÄUFER



GERMANY

Sinnocon GmbH
01156 Dresden,
Breitscheidstr. 45
Tel.: +49 351 65335641
E-mail: rabalux@sinnocon.de
www.sinnocon.de



SLOVENIA

Lagea d.o.o.
Brezina 19c
8250 Brežice
Republika Slovenija
Tel.: +386 70 292 70 20
E-mail: elmatis@lagea.si



GREECE

ANASTASIADI SA
1km Katerini-Ganohora Road,
Katerini, 60100
Tel.: +30 2351039757
E-mail: eshop@anastasiadi.gr
www.anastasiadi.gr



GREECE

S.MELISSOURGOS CO OE
8 Kourtiou St,
11146 Galatsi,
Tel.: +0030 2102136040
E-mail: info@melissourgos.com.gr
www.melissourgos.com.gr



PORTUGAL

STORM LIGHT,LDA
Rua António Pereira Vidal Xavier nº,
3750-802 Valongo do Vouga,
Tel.: 234 661 068
E-mail: geral@storm-light.pt
www.storm-light.pt



SPAIN

Buyled Led Lighting S.L
03007, Alicante,
ES, C/Gillen de Castro 1
Tel.: +0034 633460731
E-mail: info@buyled.es
www.buyled.es



ITALY

Fra.Co.Distribuzione Srl
Sp1 km24,
90047 Partinico (PA)
Tel.: 0039 0915071547
E-mail: info@fracodistribuzione.it
www.fracodistribuzione.it



FINLAND

Focus Interiors Oy
Kuusipolku 35,
37150 Nokia
Tel.: +358 (0)10 3270 520
E-mail: info@focusinteriors.fi
www.focusinteriors.fi



ALBANIA

FAAM Light sh.p.k.
Rruga Muhedin Llagani,
Kompleksi Square 21,
Tirana, Albania
Tel.: +355 67 446 6888
E-mail: info@faamlight.al
www.faamlight.al



UNITED KINGDOM

Lighting Direct
24-26 Vincent Ave,
Crownhill, Milton Keynes
Buckinghamshire, MK8 0AB
E-mail: customerservice@lighting-direct.co.uk
www.lighting-direct.co.uk



ESTONIA

Lambipesa OÜ
Tel.: +372 5124235
E-mail: eve@lambipesa.ee
www.lambipesa.ee



LITHUANIA, LATVIA

UAB LEDOK
Birutes str. 2,
Klaipėda 91200, Lithuania
Tel.: +37062068111
E-mail: B2B@ledok.lt
www.ledok.lt

CONTACT • ELÉRHETŐSÉGEK • KONTAKT

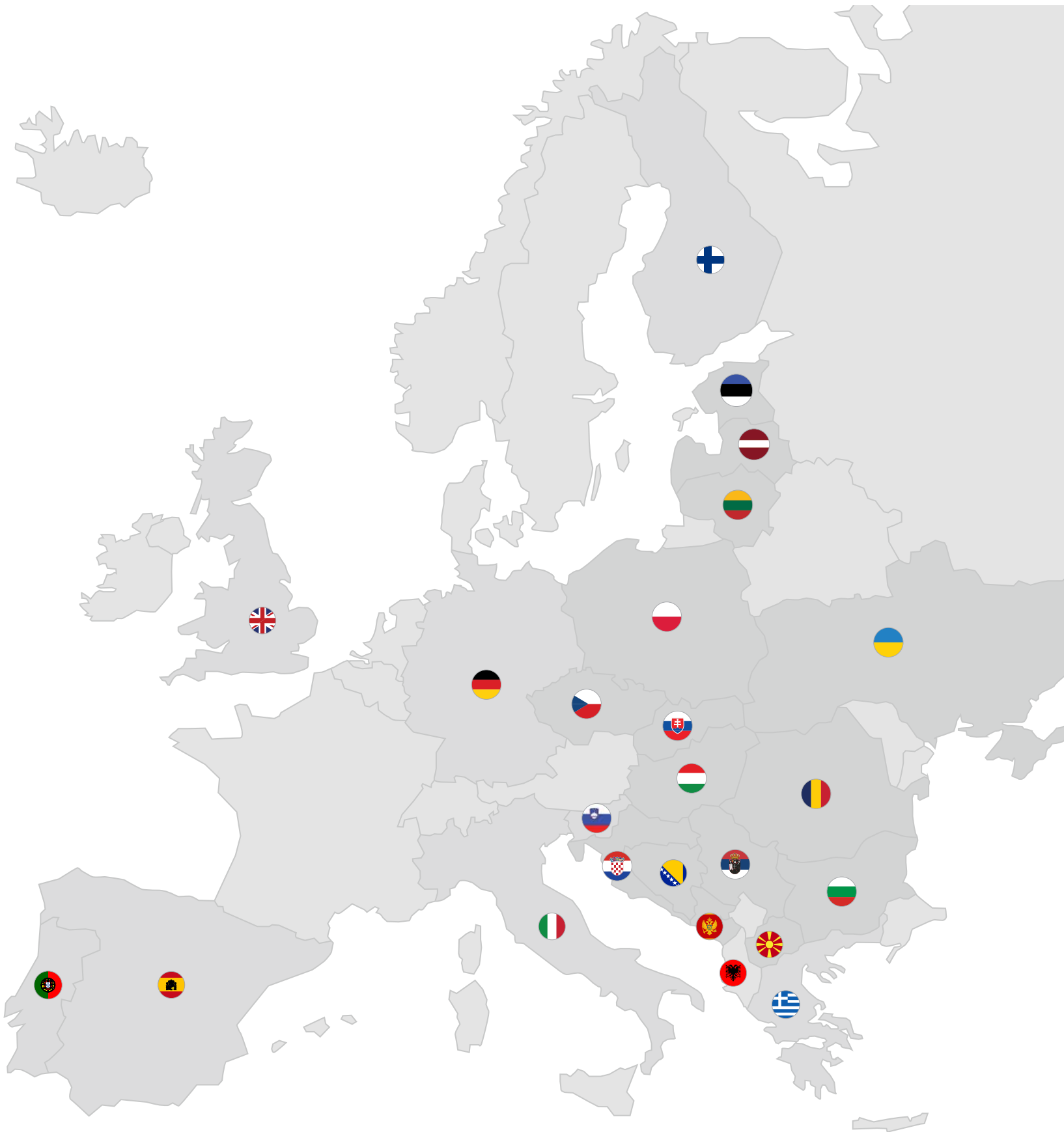





We know that choosing the right outdoor light is a complex decision: colour temperature, beam direction and spread, energy efficiency, and how the fixture fits its surroundings are all key factors.

That's why our this year's outdoor collection offers even more universal, flexible solutions. Several models feature adjustable beam angles and selectable colour temperatures, so the lighting can be finely tuned to the space and your needs — even after installation. With modern, energy-efficient technologies and versatile mounting options, planning becomes simpler while the result always delivers the exact effect you want.

Turn the page and discover our new outdoor collection!



Jól tudjuk, hogy a megfelelő kültéri lámpa kiválasztása összetett döntés: a színhőmérséklet, a fény iránya és szórása, az energiatakarékosság, valamint a környezethez való illeszkedés mind fontos szempont.

Ezért az idei kültéri kollekciónkban még több univerzális, rugalmasan alkalmazható megoldást kínálunk. Több modellnél állítható a fény vetítési szöge és a színhőmérséklet, így a világítás az adott térhez és igényekhez finoman hangolható — akár a felszerelés után is. Modern, energiatakarékos technológiáinkkal és variálható telepítési lehetőségeinkkel a tervezés egyszerűbb, az eredmény pedig mindig pontosan a kívánt hatást adja.

Lapozz tovább, és fedezd fel az új kültéri kollekciónkat!



Wir wissen, dass die Auswahl der passenden Außenleuchte eine komplexe Entscheidung ist: Farbtemperatur, Lichtausrichtung und -streuung, Energieeffizienz sowie die harmonische Integration in die Umgebung spielen dabei eine zentrale Rolle.

Deshalb bietet unsere diesjährige Außenleuchtenkollektion noch mehr universal einsetzbare, flexible Lösungen. Bei mehreren Modellen lassen sich der Abstrahlwinkel und die Farbtemperatur einstellen, sodass die Beleuchtung exakt auf den jeweiligen Bereich und die individuellen Anforderungen abgestimmt werden kann — auch nach der Montage. Mit modernen, energieeffizienten Technologien und variablen Montagemöglichkeiten wird die Planung einfacher, und das Ergebnis erzielt stets die gewünschte Lichtwirkung.

Blättere weiter und entdecke unsere neue Außenleuchten!







01

**MODERN
PRODUCT
FAMILIES**

Modern
termékcsaládok

Moderne
Produktfamilien

24-53

02

**WALL AND
CEILING LAMPS**

Fali- és
mennyezetlámpák

Wand- und
Deckenlampen

54-127

03

**CLASSIC
PRODUCT
FAMILIES**

Klasszikus
termékcsaládok

Klassische
Produktfamilien

128-147

04

**TABLE,
DECORATIVE,
AND SOLAR
LAMPS**

Asztali, dekor. és
napelemes lámpák

Tisch-, Dekor- und
Solarlampen

148-173



MODERN PRODUCT FAMILIES



TAMARITE
77206
26



TAMARITE
77207
26



CUBBINGTON
77183
27



CUBBINGTON
77184
27



CUBBINGTON
77185
27



TELDE
77101
28



TELDE
77102
28



MEDNA
77103
28



MEDNA
77104
28



CERNON
77054
29



CERNON
77055
29



CERNON
77056
29



ODIEL
77057
30



ODIEL
77058
30



ODIEL
77059
30



ODIEL
77060
30



WENGEN
77148
31



WENGEN
77149
31



PALANGA
7504
32



PALANGA
7505
32



PALANGA
7506
32



TOLNA
77171
33



TOLNA
77172
33



TOLNA
77173
33



DARVAS
77126
34



DARVAS
77127
34



DARVAS
77128
34



LEITHA
77130
35



LEITHA
77131
35



LEITHA
77132
35



ENOL
77110
36



ENOL
77111
36



ENOL
77112
36



ENOL
77113
36



ELVA
7929
37



ELVA
7930
37



BELFAST
7904
37



GORDES
77193
37



TORNIO
77071
38



TORNIO
77072
38



ANKARA
7380
39



ANKARA
7379
39



ANKARA
77026
39



ANKARA
77025
39



ANKARA
77122
39



LOANDA
77080
40



LOANDA
77081
40



LOANDA
77082
40



TEPLICE
7158
41



TEPLICE
7159
41



TARPA
77106
42



TARPA
77107
42



TARPA
77108
42



BUDAPEST
8888
43



BUDAPEST
8889
43



BUDAPEST
8890
43



ALMADA
7884
44



ALMADA
7885
44



PARAVENTO
7146
45



PARAVENTO
7147
45



PARAVENTO
7149
45



PARAVENTO
7150
45



TAVERNA
7127
46



TAVERNA
7128
46



TAVERNA
7129
46



TAVERNA
7130
46



DUBROVNIK
7238
47



DUBROVNIK
7239
47



DUBROVNIK
7240
47



BLACKTORCH
8145
48



BLACKTORCH
8146
48



BLACKTORCH
8147
48



BLACKTORCH
8148
48



BONN
8337
49



BONN
8338
49



BONN
8339
49



INOXTORCH
8261
50



INOXTORCH
8263
50



INOXTORCH
8264
50



INOXTORCH
8265
51



INOXTORCH
8266
51



INOXTORCH
8267
51



INOXTORCH
8268
51



LISBON
7826
52



LISBON
7827
52



LISBON
7828
52



LISBON
7829
52

WALL AND CEILING LAMPS



MODANE
75069
56



MODANE
75070
56



KELEBIA
77125
58



ZILINA
77052, 77053
59



KIONI
77063
60



PEMBA
77077
61



TILBURG
77049
62



TILBURG
77050
62



TEMSE
77065
63



TEMSE
77066
63



NAVIA
8130
63



FOLLINA
8154
63



RUST
77151
64



RUST
77152
64



RUST
77153
64



GERLA
77178
65



GERLA
77179
65



GERLA
77180
65



BRADU
77067
66



BRADU
77068
66



HALLSTATT
77168
67



HALLSTATT
77169
67



HALLSTATT
77170
67



SOLIN
7396
68



SOLIN
7397
68



PORTEL
77191
68



PORTEL
77192
68



LIPPA
7317
69



LIPPA
7318
69



LIPPA
7319
69



LIPPA
7320
69

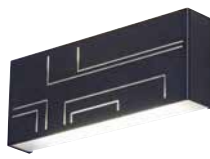

MARIBOR
8873
70



MARIBOR
8874
70



MATARO
77073
71



MATARO
77074
71



MATARO
77075
71



MATARO
77076
71



NESNA
7951
72



NESNA
7952
72



KOBARID
77174
73



MATARO
77114
73



IBAR
77109
73



OPOLE
7797
74



LUBLIN
77099
74



LUBLIN
77100
74



BIRMINGHAM
8795
75



RENNES
77042
75



RODEZ
8940
75



GIMONE
77097
76



GIMONE
77098
76



ANDELLE
77095
76



ANDELLE
77096
76



BALIMO
7476
77



BALIMO
7477
77



BALIMO
7478
77



BALIMO
7479
77



ZARAGOZA
77092
78



ZARAGOZA
77093
78



ZARAGOZA
77115
78



ZARAGOZA
77116
78



BATIDA
77117
79



BATIDA
77118
79



BATIDA
77119
79



BATIDA
77120
79



VARNA
8134
80



VARNA
8135
80



HALDEN
7935
80



SENICA
77064
81



LAXA
77121
81



RAPLA2
77150
81



URFA
77154
82



URFA
77155
82



URFA
77156
82



URFA
77157
82



URFA
77161
83



URFA
77162
83



URFA
77163
83



URFA
77164
83



URFA LINE
77209
84



URFA LINE
77210
84



URFA LINE
77211
84



URFA LINE
77212
84



SINTRA
7955
85



SINTRA
7956
85



BUFFALO
7887
85



BUFFALO
7888
85



MEDINA
8832
86



MEDINA
8833
86



MEDINA
8834
86



MEDINA
8835
86



CHILE
8029
87



CHILE
8030
87



CHILE
8018
87



CHILE
8019
87



MANDAL
7959
88



MANDAL
7960
88



PHOENIX
8118
88



PHOENIX
8119
88



WELLINGTON
7502
89



KOLTA
7386
89



NOVIGRAD
7236
90



NOVIGRAD
7237
90



SILISTRA
7891
90



SILISTRA
7892
90



ZERNEST
77085
91



ZERNEST
77086
91



ZATON
7070
91



ROMA
8409
92



ROMA
8410
92



ROMA
8511
92



ROMA
8776
92



DURANGO
8766
93



DURANGO
8767
93



SEVILLA
8799
93



SEVILLA
8800
93



ORLOVA
7244
93



ZOMBOR
7817
94



ZOMBOR
7818
94



ZOMBOR
7819
94



ZOMBOR
7820
94



AKRON
8149
95



AKRON
8150
95



KOVEN
71342
95



KOVEN
71343
95



DOLEN
75067, 75068
96



DOLEN
75065, 75066
97



MAUREC
75080
98



MAUREC
75081
98



MAUREC
75082
98



LAUTREC
75083
99



LAUTREC
75084
99



LAUTREC
75085
99



INVERNESS
7774
101



INVERNESS
7775
101



ALENZO
71431
101



ALENZO
71441
101



INDRE
77035
102



INDRE
77036
102



PERNIK
7250
103



PERNIK
7265
103



TARTU
7893, 7894
104



TARTU
7897, 7898
104



TARTU
7895, 7896
104



TARTU
7899, 7900
104



ALENZO
71425, 71426, 71427, 71429
106



ALENZO
71435, 71436, 71437, 71439
106



ALENZO
71422, 71423
107



ALENZO
71432, 71433
107



ALENZO
71428, 71430
108



ALENZO
71438, 71440
108



ALENZO
71424
108



ALENZO
71434
108



SAMIRA
71252, 71253, 71254
110



SAMIRA
71257, 71258, 71259
110



SAMIRA
71255, 71256
111



SAMIRA
71260, 71261
111



LOWAR
77133, 77135, 77182
112



LOWAR
77134, 77136, 77181
112



LUCAS
3437, 3438, 3439
114



LUCAS 2
71504, 71505, 71506
114



LUCAS 2
71510, 71511, 71512
114



ERIC
7979
115



GAELO
75025, 75026
115



ZENON
2697, 2698
115



LARCIA
75009
116



LARCIA
75010
116



STUTTART
8683
117



STUTTART
8684
117



STUTTART
8685
117



SHAUN PLUS
75071, 75072, 75073
118



SHAUN PLUS
75074, 75075, 75076
118



SHAUN PLUS
75077, 75078, 75079
118



LARCIA
75011
121



LARCIA
75012
121



LUCAS
71132, 71133, 71134
121



LOWAR
77137, 77138
122



LOWAR
77139, 77140
122



LONATO
77213
124



LONATO
77214
124



HITURA
77028
124



HITURA
77029
124



HORT
7406
125



HORT
7407
125



HORT
7408
125



HORT
7409
125



LENTIL
5810
125



AMARILLO
7969
126



AMARILLO
7980
126



TRENTO
8893
126



TRENTO
8894
126



TRENTO
77105
126



KAVALA
77189
127



KAVALA
77190
127



PUEBLO
8011
127



TACOMA
8714
127

CLASSIC PRODUCT FAMILIES



MONACO
8181
130



MONACO
8182
130



MONACO
8184
130



MONACO
8185
130



MONACO
8186
130



TORONTO
8381
131



TORONTO
8460
131



MILANO
8370
132



MILANO
8371
132



MILANO
8372
132



MILANO
8376
132



MILANO
8373
133



MILANO
8374
133



MILANO
8375
133



MILANO
7837
134



MILANO
8341
134



MILANO
8342
134



MILANO
8344
134



MILANO
8345
134



MILANO
8346
134



VELENCE
8202
135



VELENCE
8204
135



VELENCE
8206
135



VELENCE
8208
135



VELENCE
8210
135



VELENCE
8217
135



VELENCE
8201
136



VELENCE
8203
136



VELENCE
8205
136



VELENCE
8207
136



VELENCE
8209
136



VELENCE
8216
136



VELENCE
8218
137



VELENCE
8232
137



VELENCE
8234
137



VELENCE
8236
137



VELENCE
8238
137



VELENCE
8240
137



TOSCANA
8391
138



TOSCANA
8392
138



TOSCANA
8394
138



TOSCANA
8395
138



ODESSA
8163
139



ODESSA
8164
139



ODESSA
8165
139



MADRID
7836
140



MADRID
8377
140



MADRID
8476
140



MADRID
8379
141



MADRID
8480
141



OSLO
8271
142



OSLO
8681
142



OSLO
8736
142



OSLO
8737
142



OSLO
8739
142



OSLO
8740
142



OSLO
8270
143



OSLO
8763
143



OSLO
8764
143



YAGO
3309
143



OSLO
8680
144



OSLO
8682
144



OSLO
8716
144



OSLO
8717
144



VIGO
8686
145



VIGO
8687
145



DARIUS
8190
146



HEKTOR
8496
146



HEKTOR
8499
146



HAGA
8244
147



NORVICH
8753
147



NORVICH
8754
147

TABLE, DECORATIVE AND SOLAR LAMPS



POLPERRO
77146
150



POLPERRO
77147
150



MIREO
76036
151



MIREO
76037
151



MIREO
76038
151



MIREO
76039
151



FUNES
77143
152



FUNES
77144
152



FUNES
77145
152



ODERA
7040
153



BURDUR
77142
153



ALASKA
77017
155



ALASKA
77018
155



LASSET
77078
155



LASSET
77079
155



MOSELLE
77014
156



QESA
77005
156



KANGTON
77024
156



LERMOS
77203
156



NARMADA
77004
156



SEPIK
77013
157



KAPUAS
77015
157



BREZNO
77006
157



LUTTO
77030
157



MONTORO
77205
158



ISPRA
77166
158



OSTRAVA
7880
159



OSTRAVA
7881
159



OPAVA
7970
159



TARCAL
77159
160



TARCAL
77160
160



FLAXTON
77040
161



FLAXTON
77090
161



LIHULL
77020
162



MELK
77141
163



VALPOVO
77019
163



ZAVOD
77129
163



ZLARIN
77012
163



SAVOCA
77167
164



YOLA
7850
164



TAPOLCA
77176
164



SLUIS
77046
164



TRILLO
77175
165



HOLNE
77188
165



BOKOD
77187
165



DANNET
7975
165



MORA
8948
166



MORA
8949
166



KROBIA
7814
167



TURDA
7060
167



NANTES
77088
167



KELNA
77011
167



CONG
77186
168



FUNGHETTO
7877
168



RAVELLO
77158
168



MONOR
77177
169



SOLAR1
8365
169



SOLAR1
8366
169



TAVIRA
77043
170



ZIRC
77165
170



WIGRY
77001
171



BOBUS
77002
171



ANSOO
77016
172



BIRI
77123, 77124
172



LED STRIP
79021
173



LED STRIP
79022, 79023
173



Our new products are marked with magenta.
Új termékeink magenta színnel jelölve.
Unsere neuen Produkte sind mit Magenta gekennzeichnet.

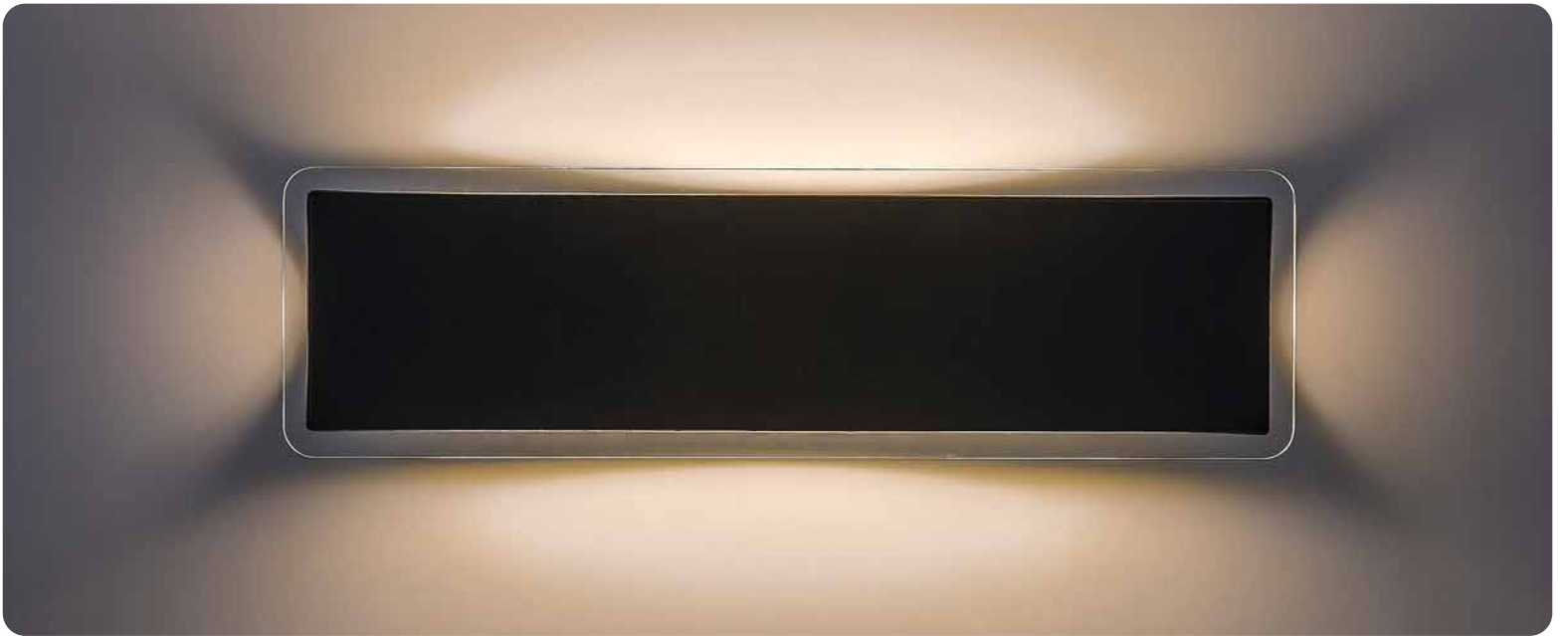



01

MODERN PRODUCT FAMILIES

MODERN TERMÉKCSALÁDOK

MODERNE PRODUKTFAMILIEN



TAMARITE



77206

65mm

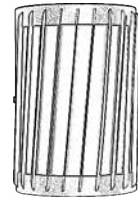

180mm

115mm



77207

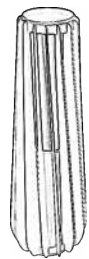

610mm

Ø 195mm

77206 (M P)

LED / 6W
(390lm, 825lm;
4000K) incl. • IP54
anthracite/white



5 996595 772062

77207 (M P)

LED / 12W
(800lm, 1690lm;
4000K) incl. • IP54
anthracite/white



5 996595 772079

CUBBINGTON



77183

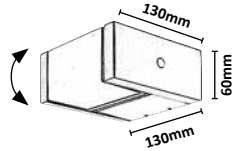

77185

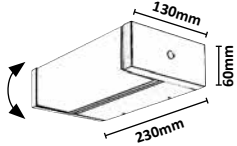

77184

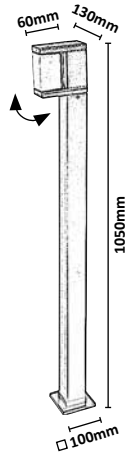

77183 (M P)

LED / 10W
 (720lm, 1200lm;
 4000K) incl. • IP54
 black/white



5 996595 771836

77184 (M P)

LED / 10W
 (740lm, 1200lm;
 4000K) incl. • IP54
 black/white



5 996595 771843

77185 (M P)

LED / 18W
 (1460lm, 2200lm;
 4000K) incl. • IP54
 black/white



5 996595 771850



TELDE



77101

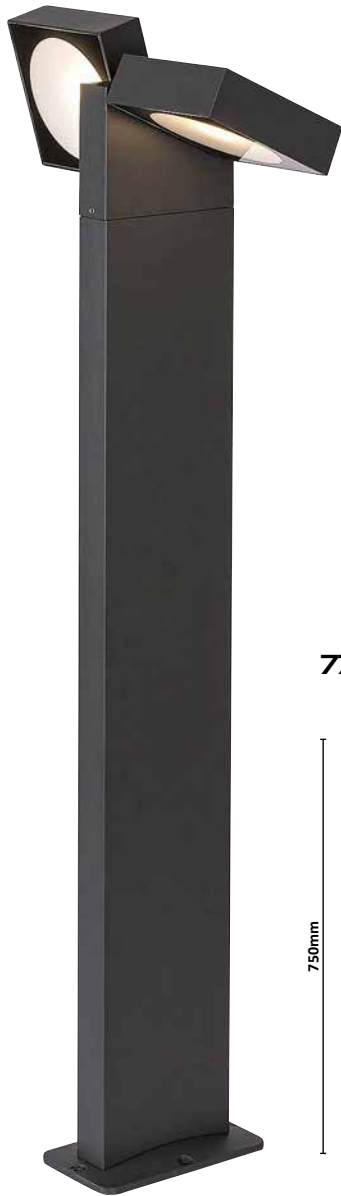
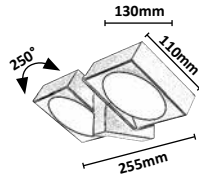

77102

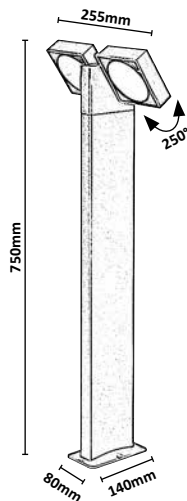

MEDNA



77103

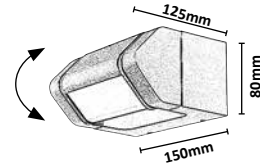

77104

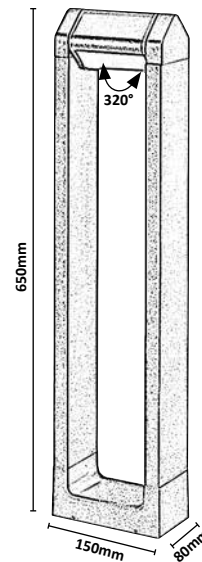

77101 M G

LED / 14W
 (900lm, 1620lm;
 3000K) incl. • IP54
 anthracite/transparent



5 996595 771010

77102 M G

LED / 14W
 (900lm, 1620lm;
 3000K) incl. • IP54
 anthracite/transparent



5 996595 771027

77103 M P

LED / 8W
 (530lm, 930lm;
 3000K) incl. • IP54
 anthracite/white



5 996595 771034

77104 M P

LED / 8W
 (530lm, 930lm;
 3000K) incl. • IP54
 anthracite/white



5 996595 771041

CERNON



77054

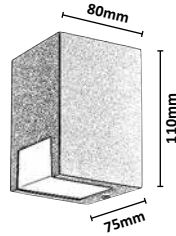

77056

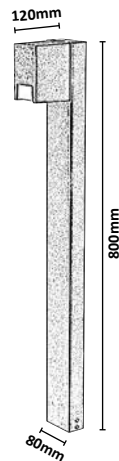

77055

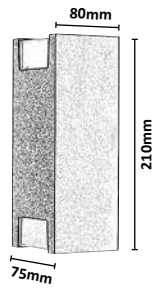

77054 (M) (P)

☒ GU10 / 1x max. 7W
IP44 • 20048
black/white



5 996595 770549

77055 (M) (P)

☒ GU10 / 2x max. 7W
IP44 • 20049
black/white



5 996595 770556

77056 (M) (P)

☒ GU10 / 1x max. 7W
IP44 • 20048
black/white



5 996595 770563



ODIEL



77057

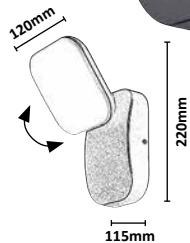

77059

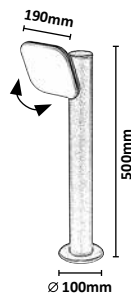

77058

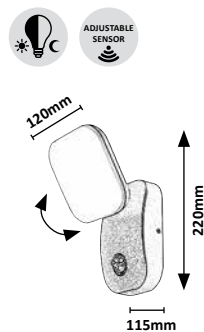

77060

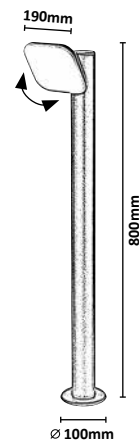

77057 (M) (P)

LED / 12W
 (800lm, 1400lm;
 3000K) incl. • IP44
 black/white



77058 (M) (P)

LED / 12W
 (850lm, 1400lm; 3000K) incl.
 IP44 • 8±2m, 110°
 black/white



77059 (M) (P)

LED / 12W
 (750lm, 1400lm;
 3000K) incl. • IP44
 black/white



77060 (M) (P)

LED / 12W
 (720lm, 1400lm;
 3000K) incl. • IP44
 black/white



WENGEN



77148

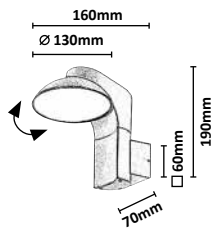

77149

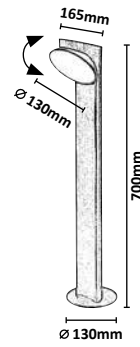

77148 (M) (P)

LED / 12W
 (☼790lm, ☼1100lm;
 3000K) incl. • IP54
 black/white



5 996595 771485

77149 (M) (P)

LED / 12W
 (☼790lm, ☼1100lm;
 3000K) incl. • IP54
 black/white



5 996595 771492

PALANGA



7504 (M P)

LED / 12W
 (800lm, 1200lm; 3000K) incl.
 IP44
 anthracite/white



7505 (M P)

LED / 12W
 (800lm, 1200lm; 3000K) incl.
 IP44 • 7m, 106°
 anthracite/white



7506 (M P)

LED / 12W
 (800lm, 1200lm; 3000K) incl.
 IP44
 anthracite/white



TOLNA



77171



77172

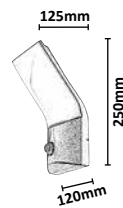

77173

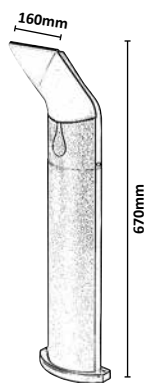

77171 (M) (P)

LED / 10W
 (750lm, 1200lm;
 3000K) incl. • IP54
 black/white



5 996595 771713

77172 (M) (P)

LED / 10W
 (770lm, 1200lm;
 3000K) incl. • IP54
 0-10m, 120° • black/white



5 996595 771720

77173 (M) (P)

LED / 10W
 (740lm, 1200lm;
 3000K) incl. • IP54
 black/white



5 996595 771737

77126, 77127, 77128



DARVAS



77126

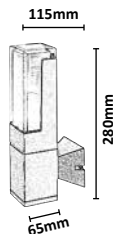

77127

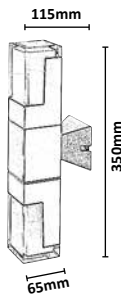

77128

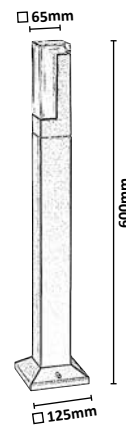

77126 (M) (P)

LED / 7W
 (450lm, 970lm;
 2700K, 4000K, 6000K) incl. • IP54
 black/white/transparent



5 996595 771263

77127 (M) (P)

LED / 12W
 (830lm, 1600lm;
 2700K, 4000K, 6000K) incl. • IP54
 black/white/transparent



5 996595 771270

77128 (M) (P)

LED / 7W
 (450lm, 970lm;
 2700K, 4000K, 6000K) incl. • IP54
 black/white/transparent



5 996595 771287

LEITHA



771B0

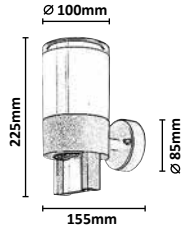

771B1

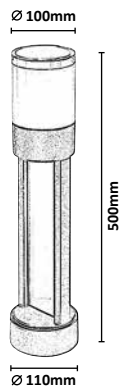

771B2

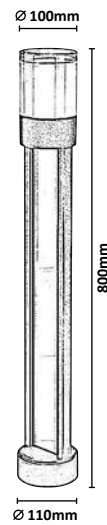

771B0 (M) (P)

LED / 12W
 (740lm, 1300lm;
 3000K) incl. • IP44
 black/white



5 996595 771300

771B1 (M) (P)

LED / 12W
 (720lm, 1300lm;
 3000K) incl. • IP44
 black/white



5 996595 771317

771B2 (M) (P)

LED / 12W
 (700lm, 1300lm;
 3000K) incl. • IP44
 black/white



5 996595 771324

ENOL



77110 **M G**

☒ GU10 / 1x max. 35W
IP44
black/transparent



77111 **M G**

☒ GU10 / 2x max. 35W
IP44
black/transparent



77112 **M G**

☒ GU10 / 1x max. 35W
IP44
black/transparent



77113 **M G**

☒ GU10 / 2x max. 35W
IP44
black/transparent



ELVA



MOVEABLE HEADS

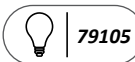

7930

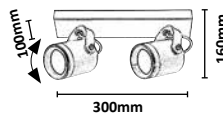

7929

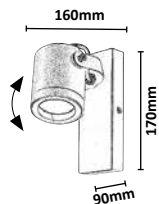

77193



BELFAST



7904

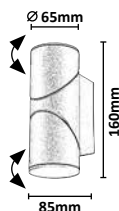

GORDES



MOVEABLE HEADS

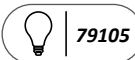

77193

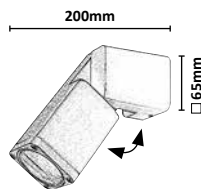

7904



7929 **M G**

☒ GU10 / 1x max. 35W
IP44
anthracite/transparent



5 998250 379296

7930 **M G**

☒ GU10 / 2x max. 35W
IP44
anthracite/transparent



5 998250 379302

7904 **M P**

☒ LED / 12,9W
(620lm, 3000K) incl.
IP65
anthracite/white



5 998250 379043

77193 **M G**

☒ GU10 / 1x max. 15W
IP65
matte black/transparent



5 996595 771935



TORNIO

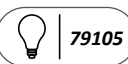

77071

∅ 60mm

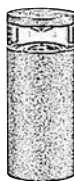

545mm



500mm



77072

∅ 60mm

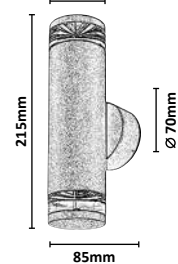

215mm

85mm

∅ 70mm

77071 (M) (A)

☒ GU10 / 1x max. 10W
IP54
anthracite/transparent



5 996595 770716

77072 (M) (A)

☒ GU10 / 2x max. 10W
IP54
anthracite/transparent



5 996595 770723

ANKARA



7380

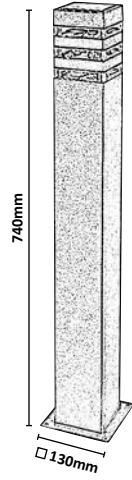

7379

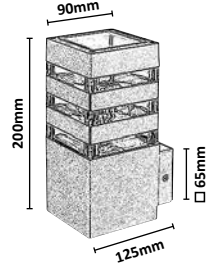

77025

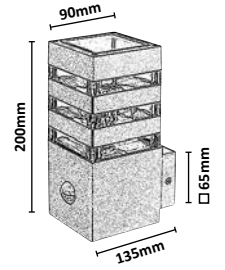

77026

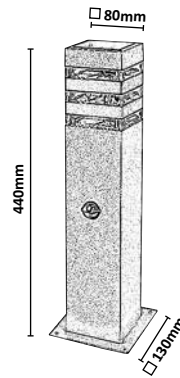

77122

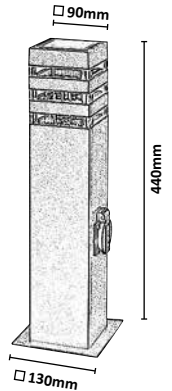

7380 (M) (P)

☒ E27 / 1x max. 12W
IP44
anthracite/transparent



5 998250 373805

7379 (M) (P)

☒ E27 / 1x max. 12W
IP44
anthracite/transparent



5 998250 373799

77026 (M) (P)

☒ E27 / 1x max. 12W
IP44 • ☒ 6-8m, 105°
anthracite/transparent



5 996595 770266

77025 (M) (P)

☒ E27 / 1x max. 12W
IP44 • ☒ 6-8m, 105°
anthracite/transparent



5 996595 770259

77122 (M) (P)

☒ E27 / 1x max. 12W
IP44
black/transparent



5 996595 771225

LOANDA



77080

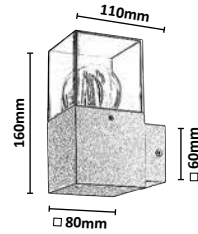

77081

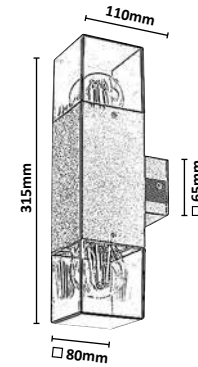

77082

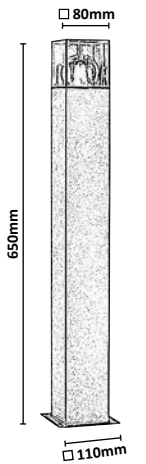

77080 (M) (P)

☒ E27 / 1x max. 12W
IP44 • 20051
black/tinted colour



5 996595 770808

77081 (M) (P)

☒ E27 / 2x max. 12W
IP44 • 20051
black/tinted colour



5 996595 770815

77082 (M) (P)

☒ E27 / 1x max. 12W
IP44 • 20051
black/tinted colour



5 996595 770822

TEPLICE

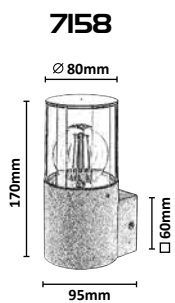
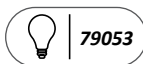

7158

∅ 80mm

170mm

95mm

60mm



7159

∅ 80mm



600mm

∅ 110mm



7158



☒ E27 / 1x max. 12W
IP44 • 19156
matte black/tinted colour



5 998250 371580

7159



☒ E27 / 1x max. 12W
IP44 • 19156
matte black/tinted colour



5 998250 371597

TARPA



77106

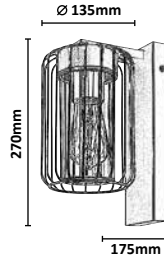

77107

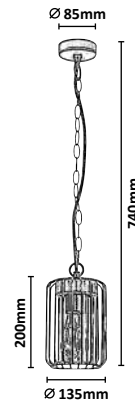

77108

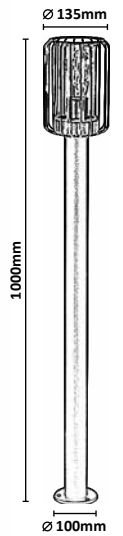

77106 (M) (P)

☒ E27 / 1x max. 40W
IP44
📏 20029
black/transparent



5 996595 771065

77107 (M) (P)

☒ E27 / 1x max. 40W
IP44
📏 20029
black/transparent



5 996595 771072

77108 (M) (P)

☒ E27 / 1x max. 40W
IP44
📏 20029
black/transparent



5 996595 771089

BUDAPEST



8888

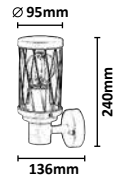

8890

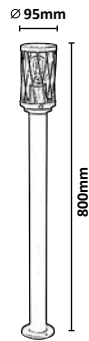

8889

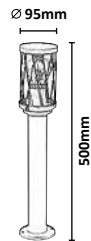

8888 (M) (P)

☒ E27 / 1x max. 40W
IP44
brown/transparent



5 998250 388885

8889 (M) (P)

☒ E27 / 1x max. 40W
IP44
brown/transparent



5 998250 388892

8890 (M) (P)

☒ E27 / 1x max. 40W
IP44
brown/transparent



5 998250 388908



ALMADA

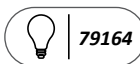

7884

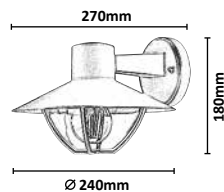

7885

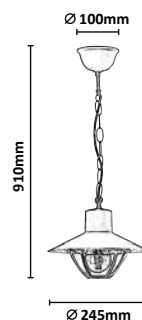

7884 (M) (P)

☒ E27 / 1x max. 10W
IP44 • 19855
brown/transparent



7885 (M) (P)

☒ E27 / 1x max. 10W
IP44 • 19855
brown/transparent



PARAVENTO



7146

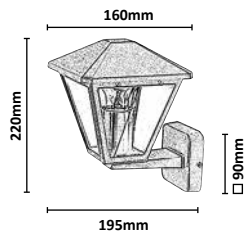

7147

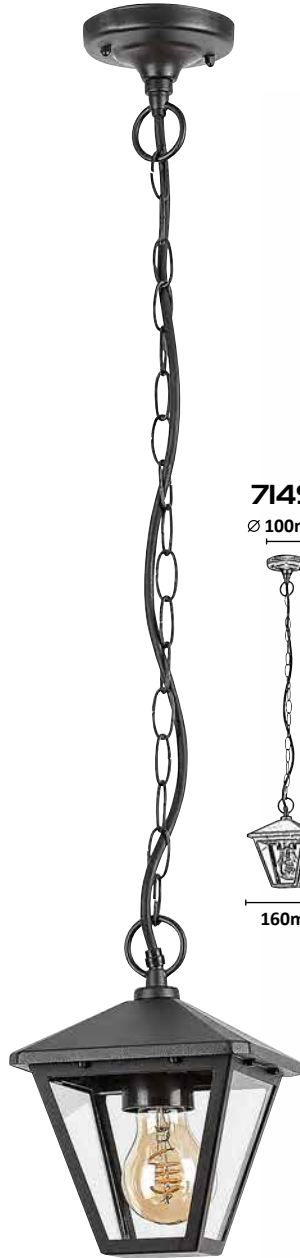
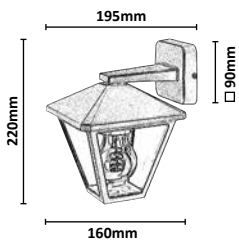

7149

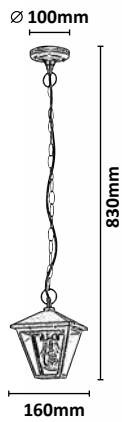

7150

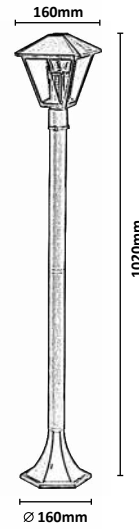

7146 (M) (G)

☒ E27 / 1x max. 40W
IP44 • 19275
black/transparent



5 998250 371467

7147 (M) (G)

☒ E27 / 1x max. 40W
IP44 • 19275
black/transparent



5 998250 371474

7149 (M) (G)

☒ E27 / 1x max. 40W
IP44 • 19275
black/transparent



5 998250 371498

7150 (M) (G)

☒ E27 / 1x max. 40W
IP44 • 19275
black/transparent



5 998250 371504



TAVERNA

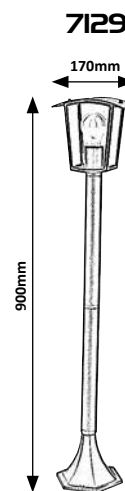
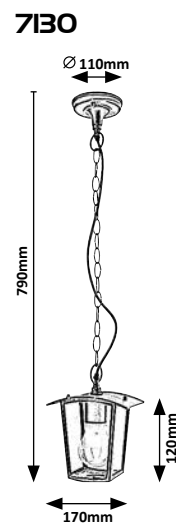
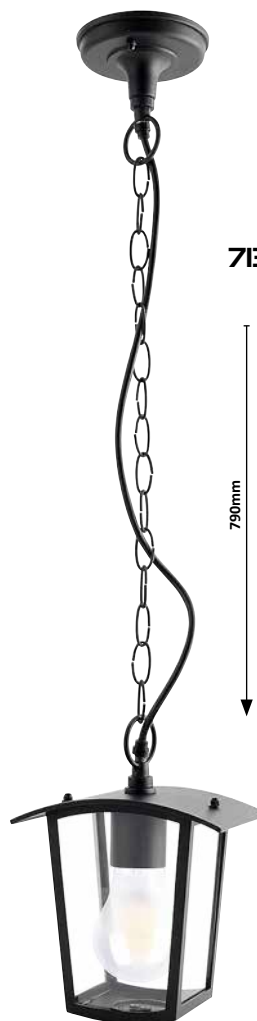
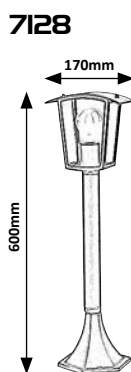
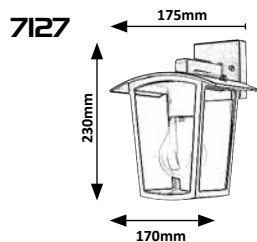

7127 (M) (P)

☒ E27 / 1x max. 15W
IP44 • 19983
black/transparent



7128 (M) (P)

☒ E27 / 1x max. 15W
IP44 • 19983
black/transparent



7129 (M) (P)

☒ E27 / 1x max. 15W
IP44 • 19983
black/transparent



7130 (M) (P)

☒ E27 / 1x max. 15W
IP44 • 19983
black/transparent



DUBROVNIK

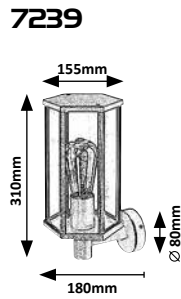
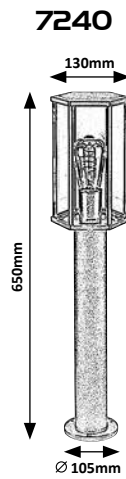
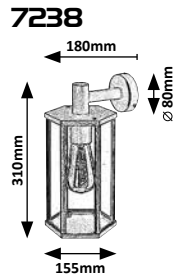

7238 (M) (G)

☒ E27 / 1x max. 40W
IP44 • 19166
matte black/transparent



5 998250 372389

7239 (M) (G)

☒ E27 / 1x max. 40W
IP44 • 19166
matte black/transparent



5 998250 372396

7240 (M) (G)

☒ E27 / 1x max. 40W
IP44 • 19166
matte black/transparent



5 998250 372402

BLACK TORCH



8145

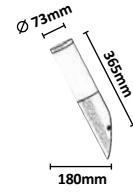

8146



8147

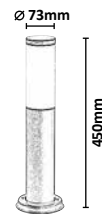

8148

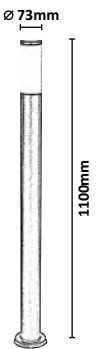

8145 (M) (P)

☒ E27 / 1x max. 25W
IP44 • 19607
matte black/white



5 998250 381459

8146 (M) (P)

☒ E27 / 1x max. 25W
IP44 • 19607
0-5m, 100°
matte black/white



5 998250 381466

8147 (M) (P)

☒ E27 / 1x max. 25W
IP44 • 19607
matte black/white



5 998250 381473

8148 (M) (P)

☒ E27 / 1x max. 25W
IP44 • 19607
matte black/white



5 998250 381480

BONN



8337

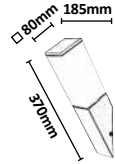

8338

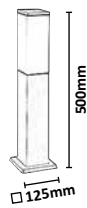

8339

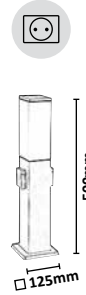

8337 (M) (P)

☒ E27 / 1x max. 60W
IP44 • 19130
matte black/white



8338 (M) (P)

☒ E27 / 1x max. 60W
IP44 • 19130
matte black/white



8339 (M) (P)

☒ E27 / 1x max. 60W
IP44 • 19130
matte black/white





INOX TORCH

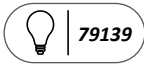

8261

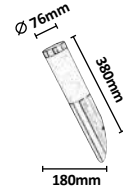

8263

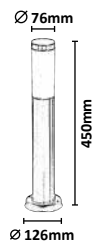

8264

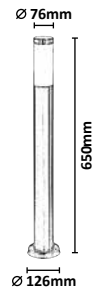

8261 (M) (P)

☒ E27 / 1x max. 25W
IP44 • 9437
satin chrome/white



8263 (M) (P)

☒ E27 / 1x max. 25W
IP44 • 9437
satin chrome/white



8264 (M) (P)

☒ E27 / 1x max. 25W
IP44 • 9437
satin chrome/white



INOX TORCH



8266

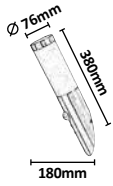

8267

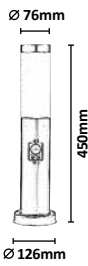

8268

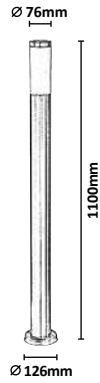

8265



8265 (M) (P)

☒ E27 / 1x max. 25W
IP44 • 9437
satin chrome/white



5 998250 382654

8266 (M) (P)

☒ E27 / 1x max. 25W
IP44 • 9437
☒ 0-5m, 100°
satin chrome/white



5 998250 382661

8267 (M) (P)

☒ E27 / 1x max. 25W
IP44 • 9437
☒ 0-5m, 100°
satin chrome/white



5 998250 382678

8268 (M) (P)

☒ E27 / 1x max. 25W
IP44 • 9437
☒ 0-5m, 100°
satin chrome /white



5 998250 382685

LISBON



7826

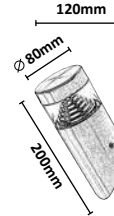

7827



7828

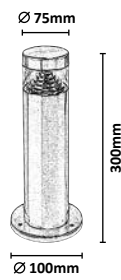

7829

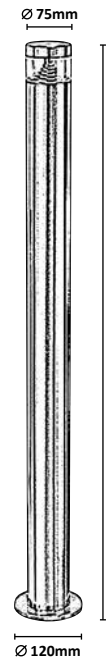

7826 (M) (P)

LED / 7W
 (560lm, 700lm;
 4000K) incl. • IP54
 stainless steel/transparent



5 998250 378268

7827 (M) (P)

LED / 7W
 (560lm, 700lm;
 4000K) incl. • IP54
 stainless steel/transparent



5 998250 378275

7828 (M) (P)

LED / 7W
 (560lm, 700lm;
 4000K) incl. • IP54
 stainless steel/transparent



5 998250 378282

7829 (M) (P)

LED / 7W
 (560lm, 700lm;
 4000K) incl. • IP54
 stainless steel/transparent



5 998250 378299





02

WALL AND CEILING LAMPS

FALI- ÉS MENNYEZETLÁMPÁK

WAND- UND DECKENLAMPEN



MODANE



75069

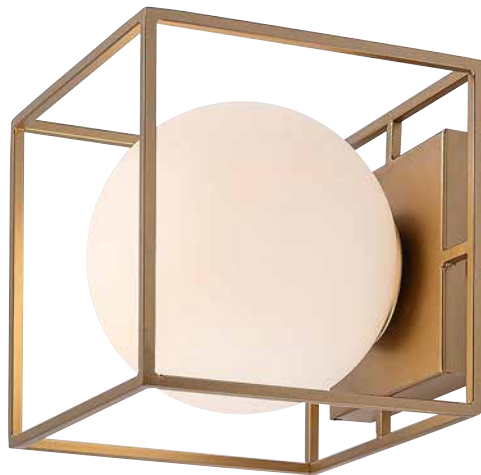
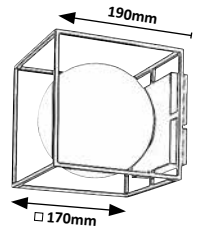

75070

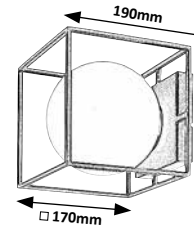

75069 **MG**

☒ E14 / 1x max. 15W
IP44 • 20112
black/white



5 996595 750695

75070 **MG**

☒ E14 / 1x max. 15W
IP44 • 20112
gold/white



5 996595 750701



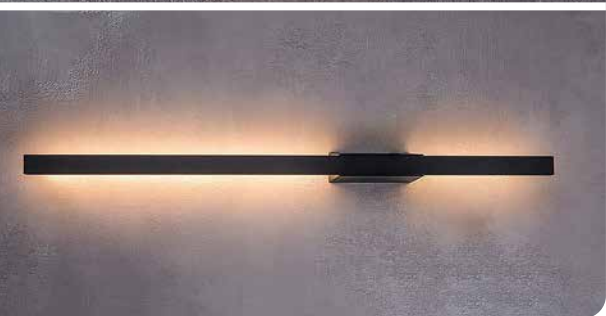

KELEBIA



77125

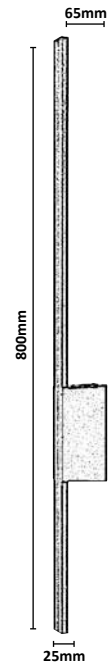

77125 (M) (P)

LED / 12W
(1000lm, 1200lm;
3000K) incl. • IP44
black/white



5 996595 771256

ZILINA

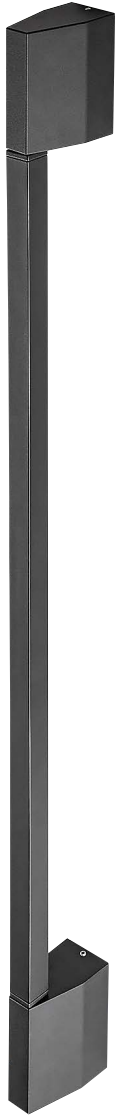

77052

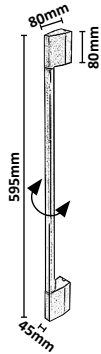

77053

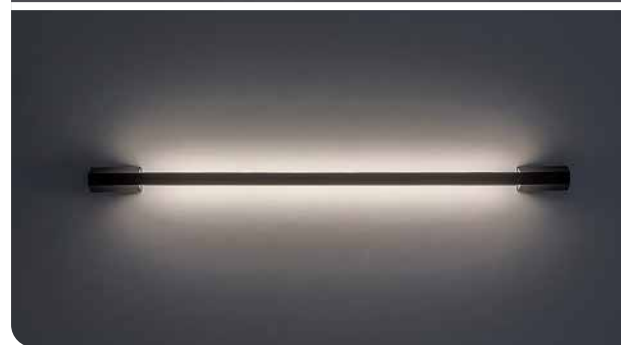
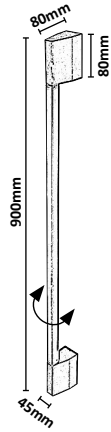

77052 (M) (P)

LED / 8W
 (320lm, 900lm;
 3000K) incl. • IP54
 matte black/white



5 996595 770525

77053 (M) (P)

LED / 8W
 (350lm, 1110lm;
 3000K) incl. • IP54
 matte black/white



5 996595 770532

KIONI



77063

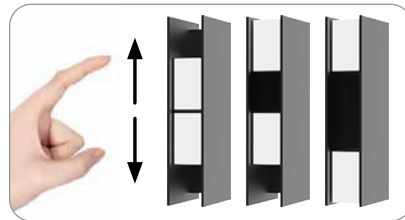
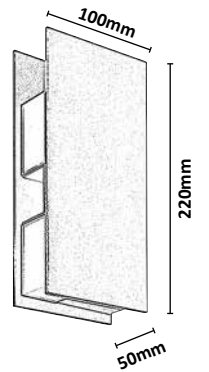

77063 (M) (P)

LED / 13W
(680lm, 1580lm;
3000K) incl. • IP65
anthracite/white



5 996595 770631

PEMBA

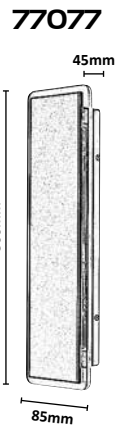

77077 **M G**

LED / 18W
(1300lm, 2060lm;
3000K) incl. • IP54
black/transparent



5 996595 770778

77049



TILBURG



77049

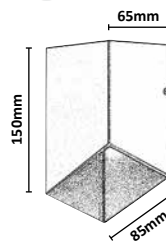

77050



77050

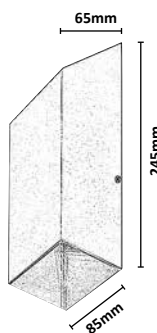

77049 **MG**

LED / 5W
(162lm, 570lm;
3000K) incl. • IP54
anthracite/transparent



5 996595 770495

77050 **MG**

LED / 10W
(356lm, 1137lm;
3000K) incl. • IP54
anthracite/transparent



5 996595 770501

TEMSE



77065

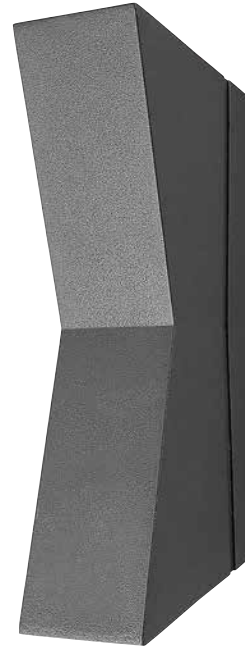
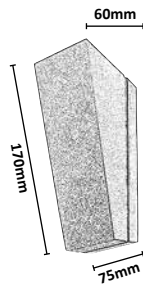

77066

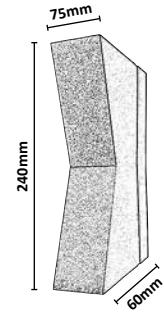

NAVIA



8130

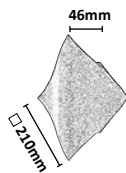

FOLLINA



8154

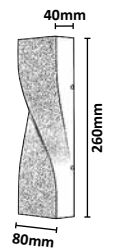

77065 (M) (P)

LED / 3W
 (140lm, 280lm;
 4000K) incl. • IP65
 anthracite/transparent



5 996595 770655

77066 (M) (P)

LED / 6W
 (290lm, 560lm;
 4000K) incl. • IP65
 anthracite/transparent



5 996595 770662

8130 (M)

LED / 11W
 (641lm, 1270lm;
 4000K) incl. • IP65
 black



5 998250 381305

8154 (M)

LED / 11W
 (530lm, 1243lm;
 4000K) incl. • IP65
 black



5 998250 381541



RUST



77152

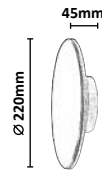

77151

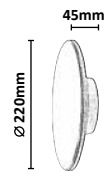

77153

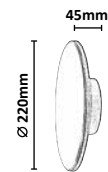

77151



LED / 15W
 (1500lm, 1700lm;
 2700K, 4000K, 6500K) incl. • IP65
 black



5 996595 771515

77152



LED / 15W
 (1500lm, 1700lm;
 2700K, 4000K, 6500K) incl. • IP65
 grey



5 996595 771522

77153



LED / 15W
 (1500lm, 1700lm;
 2700K, 4000K, 6500K) incl. • IP65
 brown



5 996595 771539

GERLA



77178

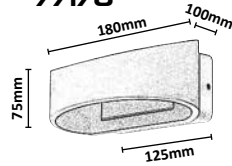

77179

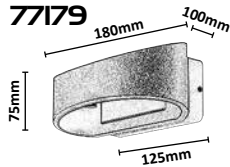

77180

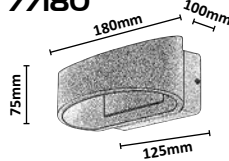

77178 (M P)

LED / 9W
 (3370lm, 1100lm;
 3000K) incl. • IP54
 white



5 996595 771782

77179 (M P)

LED / 9W
 (400lm, 1100lm;
 3000K) incl. • IP54
 anthracite



5 996595 771799

77180 (M P)

LED / 9W
 (400lm, 1100lm;
 3000K) incl. • IP54
 brown



5 996595 771805

BRADU



77067

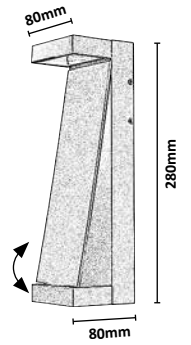

77068

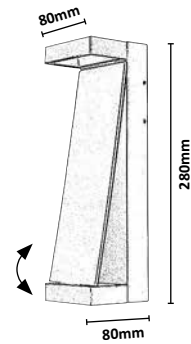

77067 **M G**

LED / 12W
 (845lm, 1400lm;
 3000K) incl. • IP65
 anthracite/transparent



5 996595 770679

77068 **M G**

LED / 12W
 (890lm, 1400lm;
 3000K) incl. • IP65
 brown/transparent



5 996595 770686

HALLSTATT



77168

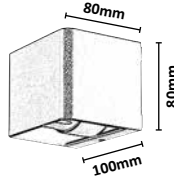

77169

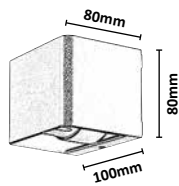

77170

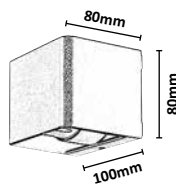

77168, 77169, 77170

INDIRECT



77168 **M G**

LED / 10W
 (320lm, 1100lm;
 3000K) incl. • IP54
 antrachite/transparent



5 996595 771683

77169 **M G**

LED / 10W
 (320lm, 1100lm;
 3000K) incl. • IP54
 brown/transparent



5 996595 771690

77170 **M G**

LED / 10W
 (360lm, 1100lm;
 3000K) incl. • IP54
 grey/transparent



5 996595 771706

7396, 7397

INDIRECT



SOLIN



7396

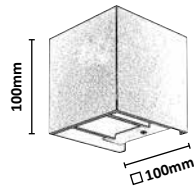

7397

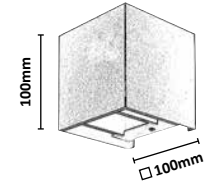

PORTEL

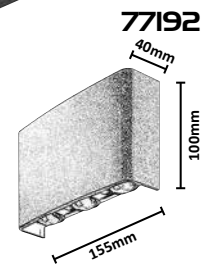
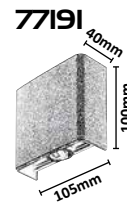

7396 (M) (P)

☒ G9 / 1x max. 5W
IP54
matte black



7397 (M) (P)

☒ G9 / 1x max. 5W
IP54
matte white



77191 (P)

☒ LED / 2W
(⊗160lm, ⊗200lm;
2000K, 2700K, 4000K) incl.
IP65 • black/transparent



77192 (P)

☒ LED / 5W
(⊗450lm, ⊗550lm;
2000K, 2700K, 4000K) incl.
IP65 • black/transparent



LIPPA

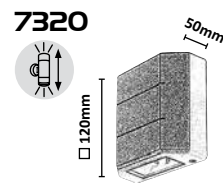
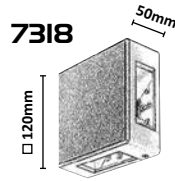
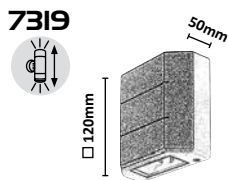
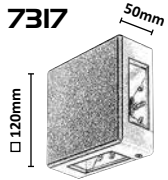

7317, 7318

INDIRECT



7319, 7320

INDIRECT



7317 (P)

LED / 6W
 (190lm, 660lm;
 3000K) incl. • IP54
 black



5 998250 373171

7318 (P)

LED / 6W
 (360lm, 660lm;
 3000K) incl. • IP54
 white



5 998250 373188

7319 (P)

LED / 6W
 (70lm, 660lm;
 3000K) incl. • IP54
 black



5 998250 373195

7320 (P)

LED / 6W
 (150lm, 660lm;
 3000K) incl. • IP54
 white



5 998250 373201

8873

INDIRECT



MARIBOR

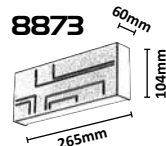
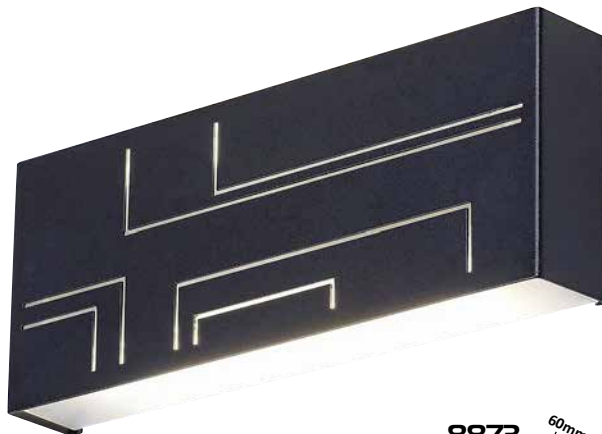

8874

INDIRECT

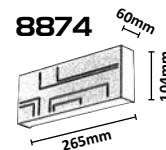

8873 (M) (P)

LED / 12W
(780lm, 1300lm;
4000K) incl. • IP65
black/white



8874 (M) (P)

LED / 12W
(780lm, 1300lm;
4000K) incl. • IP65
white



MATARO

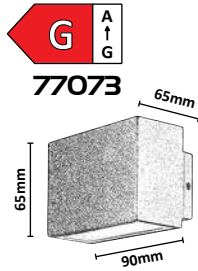

G A ↑ G
77073

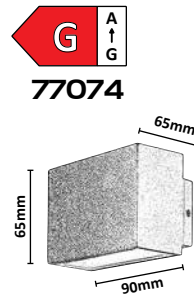

G A ↑ G
77074

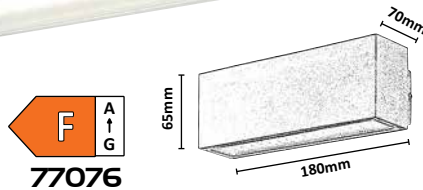

F A ↑ G
77076

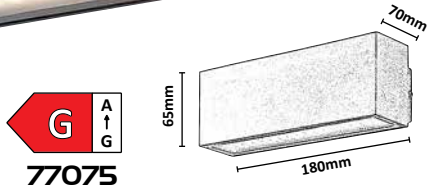

G A ↑ G
77075



77073 (M) (G)

LED / 7W
(430lm, 800lm;
4000K) incl. • IP54
black/white



5 996595 770730

77074 (M) (G)

LED / 7W
(580lm, 800lm;
4000K) incl. • IP54
white



5 996595 770747

77075 (M) (G)

LED / 10W
(720lm, 1200lm;
4000K) incl. • IP54
black/white



5 996595 770754

77076 (M) (G)

LED / 10W
(970lm, 1200lm;
4000K) incl. • IP54
white



5 996595 770761



NESNA



7951

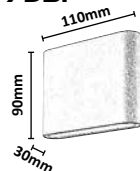

7952

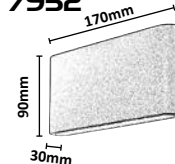

7951 **M G**

LED / 6W
(386lm, 900lm; 3000K) incl.
IP54 • 19626
anthracite/opal glass



5 998250 379517

7952 **M G**

LED / 12W
(528lm, 700lm; 3000K) incl.
IP54 • 19630
anthracite/opal glass



5 998250 379524

KOBARID

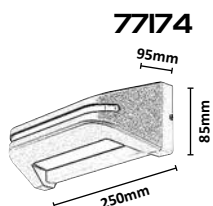

77174



77109



MATARO

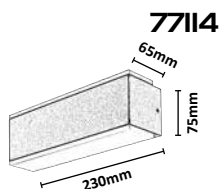

IBAR



77114



77174 (M) (P)

LED / 20W
 (800lm, 2300lm;
 4000K) incl. • IP54
 black/white



77114 (M) (P)

LED / 12W
 (950lm, 1200lm;
 3000K) incl. • IP54
 black/white



77109 (P)

LED / 3W
 (250lm, 300lm;
 3000K) incl. • IP54
 black/transparent



OPOLE

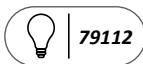

7797

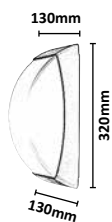

LUBLIN



77100

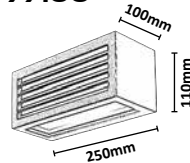

77099

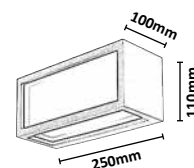

7797



☒ E27 / 1x max. 12W
IP65
matte black/white



5 998250 377971

77099



☑ LED / 10W
(☑480lm, ☑1000lm; 4000K) incl.
IP54 • ⚡ 20053
black/white



5 996595 770990

77100



☑ LED / 10W
(☑480lm, ☑1000lm; 4000K) incl.
IP54 • ⚡ 20053
black/white



5 996595 771003

BIRMINGHAM

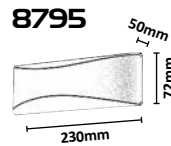

RENNES

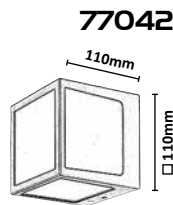

RODEZ

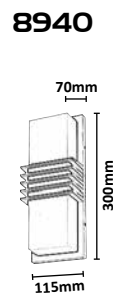

8795 (M) (P)

LED / 7W
(796lm, 4000K) incl.
IP65
anthracite/white



77042 (P)

LED / 10W
(580lm, 1000lm;
4000K) incl. • IP54
anthracite/white



8940 (M) (P)

LED / 12W
(800lm, 1458lm;
4000K) incl. • IP44
anthracite/white





GIMONE



ANDELLE



77097 (P)

LED / 10W
(570lm, 1000lm;
4000K) incl. • IP44
black/white



5 996595 770976

77098 (P)

LED / 10W
(660lm, 1000lm;
4000K) incl. • IP44
white



5 996595 770983

77095 (P)

LED / 10W
(500lm, 1000lm;
3000K) incl. • IP54
black/white



5 996595 770952

77096 (P)

LED / 10W
(570lm, 1000lm;
3000K) incl. • IP54
white



5 996595 770969

BALIMO



7477

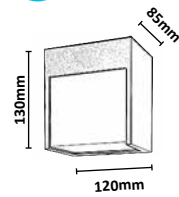

7476

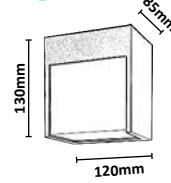

7479

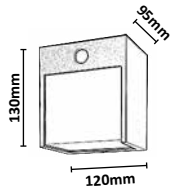

7478

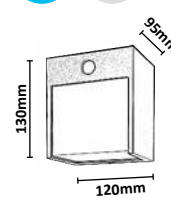

7479



7476



7476 (M) (P)

LED / 12W
 (560lm, 1200lm;
 4000K) incl. • IP54
 matte black/white



5 998250 374765

7477 (M) (P)

LED / 12W
 (560lm, 1200lm;
 4000K) incl. • IP54
 matte white/white



5 998250 374772

7478 (M) (P)

LED / 12W
 (560lm, 1200lm; 4000K) incl.
 IP54 • 7m, 106°
 matte black/white



5 998250 374789

7479 (M) (P)

LED / 12W
 (560lm, 1200lm; 4000K) incl.
 IP54 • 7m, 106°
 matte white/white



5 998250 374796

77115, 77116



ZARAGOZA



77092

NATURAL White

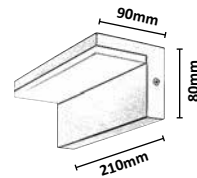

77093

NATURAL White

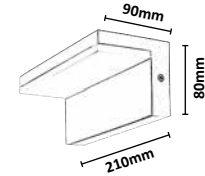

77115

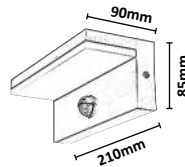

77116

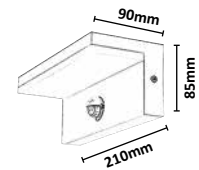

77092 (P)

LED / 10W
 (8560lm, 10000lm;
 4000K) incl. • IP54
 black/white



5 996595 770921

77093 (P)

LED / 10W
 (780lm, 10000lm;
 4000K) incl. • IP54
 white



5 996595 770938

77115 (P)

LED / 9W
 (800lm, 10000lm;
 2700K, 4000K, 6500K) incl. • IP54
 6-8m, 110° • black/white



5 996595 771157

77116 (P)

LED / 9W
 (850lm, 10000lm;
 2700K, 4000K, 6500K) incl. • IP54
 6-8m, 110° • white



5 996595 771164

BATIDA

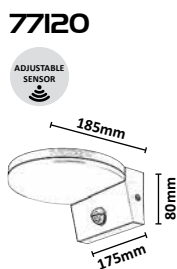
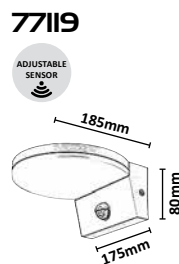
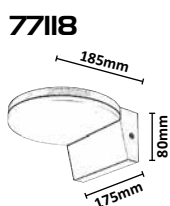
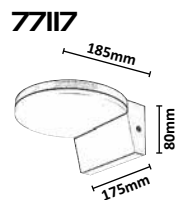

77117, 77118, 77119, 77120



77117

(P)

LED / 9W
 (900lm, 1000lm;
 2700K, 4000K, 6500K) incl. • IP54
 black/white



5 996595 771171

77118

(P)

LED / 9W
 (950lm, 1000lm;
 2700K, 4000K, 6500K) incl. • IP54
 white



5 996595 771188

77119

(P)

LED / 9W
 (900lm, 1000lm;
 2700K, 4000K, 6500K) incl. • IP54
 6-8m, 110° • black/white



5 996595 771195

77120

(P)

LED / 9W
 (950lm, 1000lm;
 2700K, 4000K, 6500K) incl. • IP54
 6-8m, 110° • white



5 996595 771201



VARNA



8134



8135



HALDEN



7935

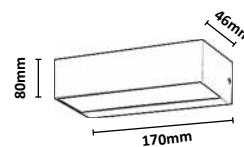

8134 (P)

LED / 12W
 (720lm, 1000lm;
 4000K) incl. • IP54
 black/white



8135 (P)

LED / 12W
 (720lm, 1000lm;
 4000K) incl. • IP54
 8m, 120° • black/white



7935 (P)

LED / 9W
 (640lm, 800lm;
 4000K) incl. • IP65
 black/white



SENICA

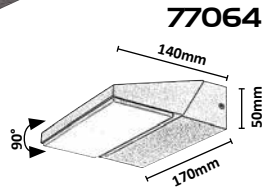

LAXA

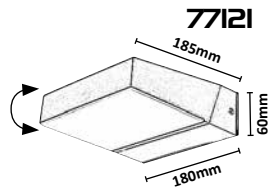

RAPLA 2

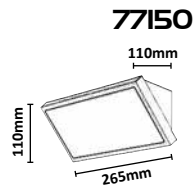

77064 (M) (P)

LED / 13W
 (☉540lm, ☉1450lm;
 4000K) incl. • IP65
 black/white



77121 (P)

LED / 14W
 (☉1400lm, ☉1500lm;
 2700K, 4000K, 6500K) incl. • IP54
 black/white



77150 (P)

LED / 18W
 (☉1700lm, ☉1900lm;
 2700K, 4000K, 6500K) incl. • IP65
 black/white



77154, 77155, 77156, 77157

URFA



77154

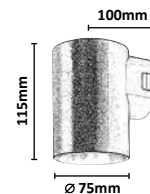

77155

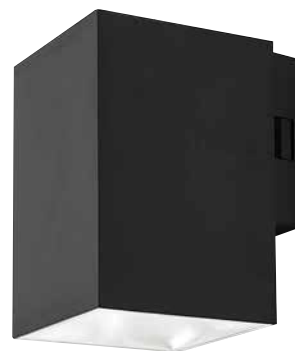
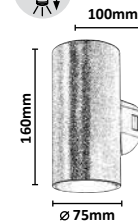

77156

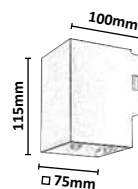

77157

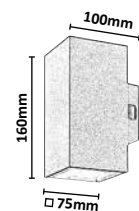

77154



LED / 9W
 (9900lm, 9990lm;
 2700K, 4000K, 6500K) incl. • IP65
 black



5 996595 771546

77155



LED / 18W
 (18000lm, 19800lm;
 2700K, 4000K, 6500K) incl. • IP65
 black



5 996595 771553

77156



LED / 9W
 (9900lm, 9990lm;
 2700K, 4000K, 6500K) incl. • IP65
 black



5 996595 771560

77157



LED / 18W
 (18000lm, 19800lm;
 2700K, 4000K, 6500K) incl. • IP65
 black



5 996595 771577

URFA



77161, 77162, 77163, 77164



77162

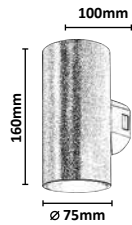

77161

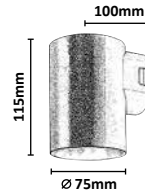

77163

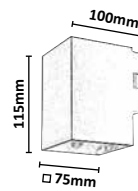

77164

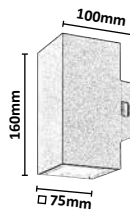

77161



LED / 9W
(9900lm, 9990lm;
2700K, 4000K, 6500K) incl. • IP65
white



5 996595 771614

77162



LED / 18W
(1800lm, 1980lm;
2700K, 4000K, 6500K) incl. • IP65
white



5 996595 771621

77163



LED / 9W
(9900lm, 9990lm;
2700K, 4000K, 6500K) incl. • IP65
white



5 996595 771638

77164



LED / 18W
(1800lm, 1980lm;
2700K, 4000K, 6500K) incl. • IP65
white



5 996595 771645

77209, 77210, 77211, 77212

URFA LINE

CCT SWITCH



77209

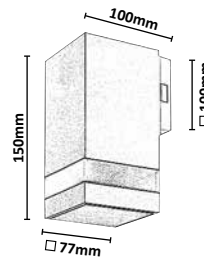

77210

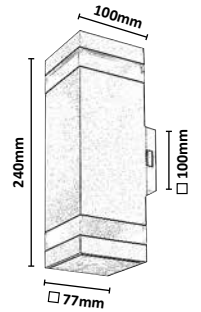

77212

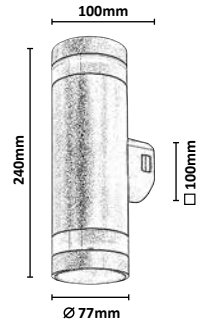

77211

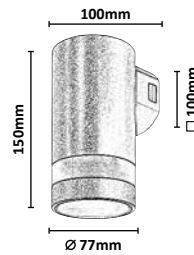

77209



LED / 9W
 (810lm, 900lm;
 3000K, 4000K, 6500K) incl. • IP65
 anthracite/transparent



5 996595 772093

77210



LED / 16W
 (1500lm, 1800lm;
 3000K, 4000K, 6500K) incl. • IP65
 anthracite/transparent



5 996595 772109

77211



LED / 9W
 (800lm, 900lm;
 3000K, 4000K, 6500K) incl. • IP65
 brown/transparent



5 996595 772116

77212



LED / 16W
 (1400lm, 1800lm;
 3000K, 4000K, 6500K) incl. • IP65
 brown/transparent



5 996595 772123

SINTRA



7955

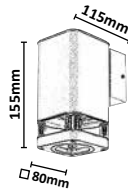

7956

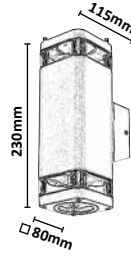

BUFFALO



7887

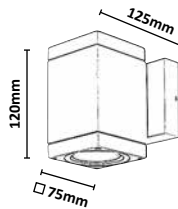

7888

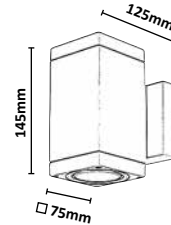

7955 **M P**

☒ GU10 / 1x max. 25W
IP44
matte black/transparent



5 998250 379555

7956 **M P**

☒ GU10 / 2x max. 25W
IP44
matte black/transparent



5 998250 379562

7887 **M G**

☒ GU10 / 1x max. 35W
IP54
anthracite/transparent



5 998250 378879

7888 **M G**

☒ GU10 / 2x max. 35W
IP54
anthracite/transparent



5 998250 378886



MEDINA

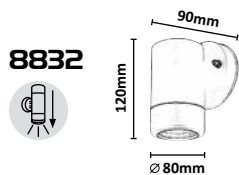

8832



8834

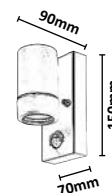

8833



8835

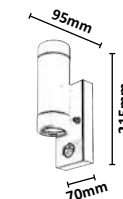

8832

P

☒ GU10 / 1x max. 10W
IP44
matte black/transparent



5 998250 388328

8833

P

☒ GU10 / 2x max. 10W
IP44
matte black/transparent



5 998250 388335

8834

P

☒ GU10 / 1x max. 10W
IP44
☒ 2-8m, 90°
matte black/transparent



5 998250 388342

8835

P

☒ GU10 / 2x max. 10W
IP44
☒ 2-8m, 90°
matte black/transparent



5 998250 388359

CHILE



8029

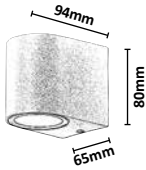

8018

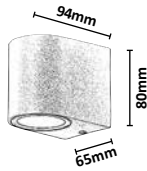

8030



8019



8029 **M G**

☒ GU10 / 1x max. 35W
IP44
black



5 998250 380292

8030 **M G**

☒ GU10 / 2x max. 35W
IP44
black



5 998250 380308

8018 **M G**

☒ GU10 / 1x max. 35W
IP44
antique brown



5 998250 380186

8019 **M G**

☒ GU10 / 2x max. 35W
IP44
antique brown



5 998250 380193



MANDAL

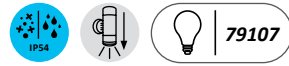

7960

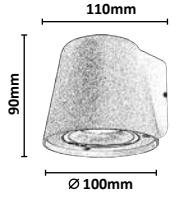

7959

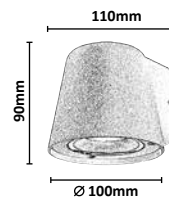

PHOENIX



8118



8119

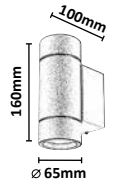

7959 **M G**

☒ GU10 / 1x max. 35W
IP54
matte black/transparent



5 998250 379593

7960 **M G**

☒ GU10 / 1x max. 35W
IP54
matte white/transparent



5 998250 379609

8118 **M G**

☒ GU10 / 1x max. 10W
IP54 • 19625
anthracite/transparent



5 998250 381183

8119 **M G**

☒ GU10 / 2x max. 10W
IP54 • 19625
anthracite/transparent



5 998250 381190

WELLINGTON



7502

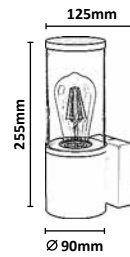

KOLTA



7386

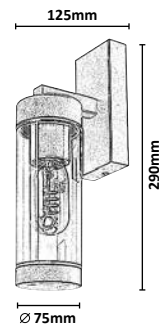

7502

(M) (P)

☒ E27 / 1x max. 60W
IP44 • 19978
matte black/transparent



5 998250 375021

7386

(M) (P)

☒ E27 / 1x max. 12W
IP44 • 19150
matte black/transparent



5 998250 373867



NOVIGRAD



7236

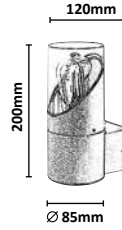

7237

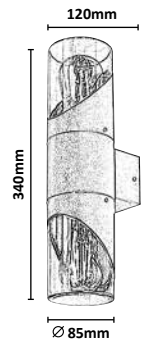

SILISTRA



7892

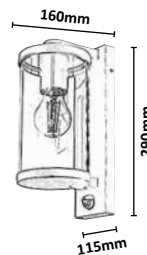

7891

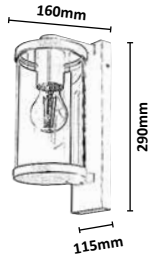

7236 (M) (P)

☒ E27 / 1x max. 28W
IP54 • 19168
black/transparent



7237 (M) (P)

☒ E27 / 2x max. 28W
IP54 • 19168
black/transparent



7891 (M) (G)

☒ E27 / 1x max. 60W
IP44 • 19852
anthracite/transparent



7892 (M) (G)

☒ E27 / 1x max. 60W
IP44 • 19852
☑ 1-12m, 110°
anthracite/transparent



ZERNEST



77085

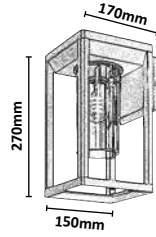

77086

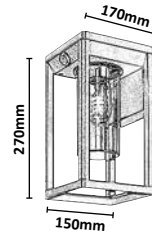

ZATON



7070

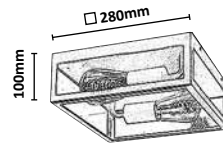

77085 (M) (P)

⊗ E27 / 1x max. 15W
IP54 • 20056
black/transparent



5 996595 770853

77086 (M) (P)

⊗ E27 / 1x max. 15W
IP54 • 20056
2-6m, 110°
black/transparent



5 996595 770860

7070 (M) (G)

⊗ E27 / 2x max. 60W
IP23 • 19246
matte black/transparent



5 998250 370705

ROMA



8409

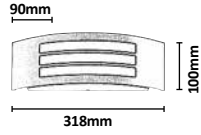

8511

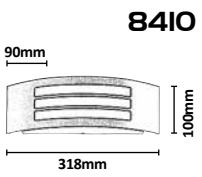
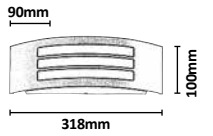

8410

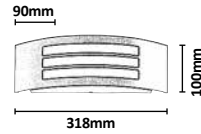

8776



8409 (M) (P)

☒ E27 / 1x max. 14W
IP44
matte black/white



5 998250 384092

8410 (M) (P)

☒ E27 / 1x max. 14W
IP44
satin chrome/white



5 998250 384108

8511 (M) (P)

☒ E27 / 1x max. 14W
IP44
antique gold/white



5 998250 385112

8776 (M) (P)

☒ E27 / 1x max. 14W
IP44
anthracite/white



5 998250 387765

DURANGO



8766

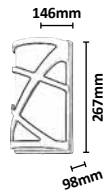

8767



ORLOVA



7244

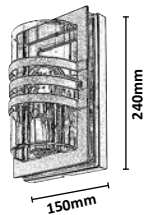

SEVILLA



8799

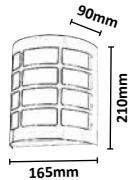

8800

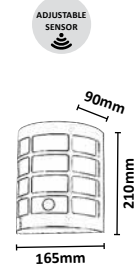

8766 (M P)

☒ E27 / 1x max. 40W
IP54
brown/white



5 998250 387666

8767 (M P)

☒ E27 / 1x max. 40W
IP54
anthracite/white



5 998250 387673

8799 (M P)

☒ E27 / 1x max. 11W
IP44
satin chrome/white



5 998250 387994

8800 (M P)

☒ E27 / 1x max. 11W
IP44 • 0-5m, 100°
satin chrome/white



5 998250 388007

7244 (M P)

☒ E27 / 1x max. 40W
IP44 • 19177
black/transparent



5 998250 372440

ZOMBOR

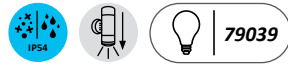

7817

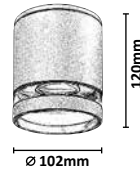

7818

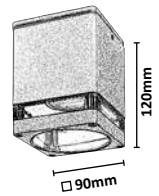

7819

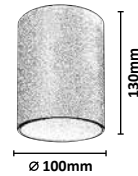

7820

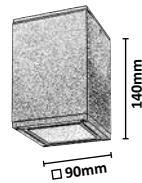

7817 (M) (P)

☒ GU10 / 1x max. 35W
IP54
anthracite/transparent



7818 (M) (P)

☒ GU10 / 1x max. 35W
IP54
anthracite/transparent



7819 (M) (G)

☒ GU10 / 1x max. 35W
IP54
anthracite/opal glass



7820 (M) (G)

☒ GU10 / 1x max. 35W
IP54
anthracite/opal glass



AKRON



8149

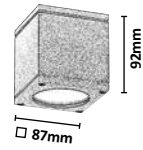

8150

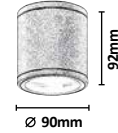

KOVEN

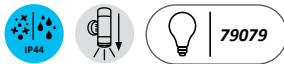

71343

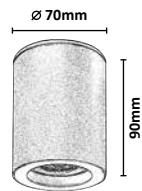

71342

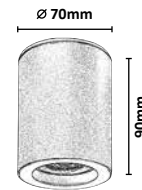

8149 **M G**

☒ GU10 / 1x max. 35W
IP54
anthracite/transparent



5 998250 381497

8150 **M G**

☒ GU10 / 1x max. 35W
IP54
anthracite/transparent



5 998250 381503

71342 **M G**

☒ GU10 / 1x max. 35W
IP44
black



5 996595 713423

71343 **M G**

☒ GU10 / 1x max. 35W
IP44
white



5 996595 713430



DOLEN

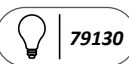

75067

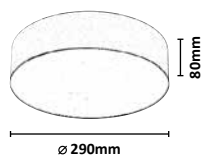

75068

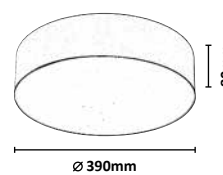

75067 (M) (P)

☒ E27 / 2x max. 9W
IP43
grey-beige/white



5 996595 750671

75068 (M) (P)

☒ E27 / 3x max. 9W
IP43
grey-beige/white



5 996595 750688

DOLEN

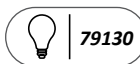

75065

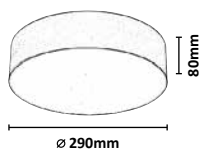

75066

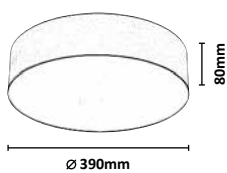

75065 (M) (P)

☒ E27 / 2x max. 9W
IP43
black/white



5 996595 750657

75066 (M) (P)

☒ E27 / 3x max. 9W
IP43
black/white



5 996595 750664



MAUREC



PLASTIC



75080



75081



75082



75080



LED / 18W
 (1540lm, 1900lm;
 3000K, 4000K, 6000K) incl.
 IP44 • brown/white



5 996595 750800

75081



LED / 18W
 (1575lm, 1900lm;
 3000K, 4000K, 6000K) incl.
 IP44 • anthracite/white



5 996595 750817

75082



LED / 18W
 (1550lm, 1900lm;
 3000K, 4000K, 6000K) incl.
 IP44 • wood imitation/white



5 996595 750824

LAUTREC



75083

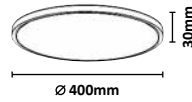

75084

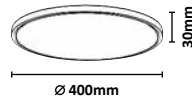

75085

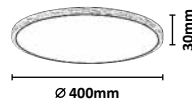

75083



LED / 24W
 (2030lm, 2640lm;
 3000K, 4000K, 6500K) incl.
 IP44 • brown/white



5 996595 750831

75084



LED / 24W
 (2030lm, 2640lm;
 3000K, 4000K, 6500K) incl.
 IP44 • antrachite/white



5 996595 750848

75085



LED / 24W
 (2030lm, 2640lm;
 3000K, 4000K, 6500K) incl.
 IP44 • wood imitation/white



5 996595 750855

71431, 71441



7774, 7775



INVERNESS

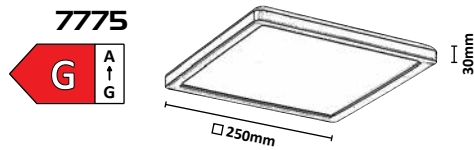
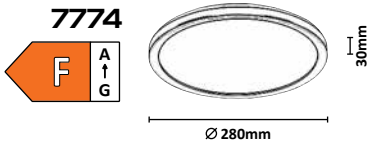

ALENZO

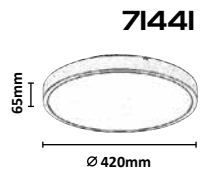
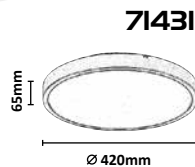

7774 (P)
 LED / 15W
 (1300lm, 2000lm;
 2700K-6500K) incl. • IP44
 555 • black/white



5 998250 377742

7775 (P)
 LED / 15W
 (1190lm, 1800lm;
 2700K-6500K) incl. • IP44
 555 • black/white



5 998250 377759

7143I (P)
 LED / 36W
 (2450lm, 3600lm;
 3000K, 4000K, 6000K) incl.
 IP44 • white



5 996595 714314

7144I (P)
 LED / 36W
 (2380lm, 3600lm;
 3000K, 4000K, 6000K) incl.
 IP44 • black/white



5 996595 714413

77035, 77036



INDRE



77035

Ø 300mm



77036

Ø 300mm



77035



LED / 28W
(2450lm, 3450lm;
3000K, 4000K, 6500K) incl. • IP54
black/white



5 996595 770358

77036



LED / 28W
(2600lm, 3450lm;
3000K, 4000K, 6500K) incl. • IP54
white



5 996595 770365

PERNIK



7250

NATURAL
White



7265

WARM
White



7250

P

LED / 24W
 (2400lm, 2565lm; 4000K) incl.
 IP54
 black/white



5 998250 372501

7265









P



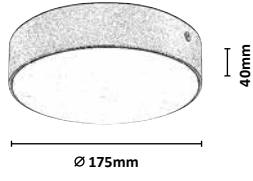



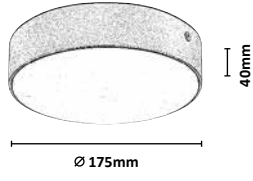

LED / 24W
 (2400lm, 2565lm; 3000K) incl.
 IP54
 black/white



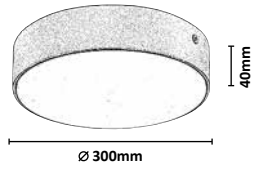



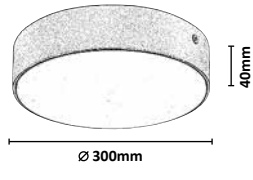





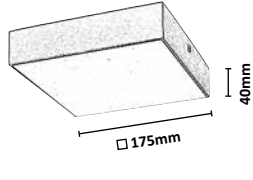



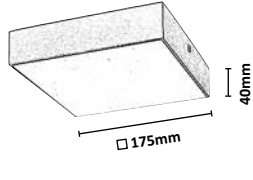

5 998250 372655

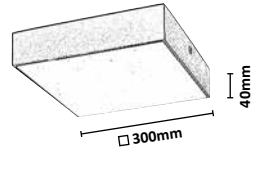

	<p>7893</p> <p>LED / 18W (1800lm, 1980lm); 2800K, 4000K, 6000K) incl. IP44 • matte white/white</p>			 <p>5 998250 378930</p>
	<p>7897</p> <p>LED / 18W (1800lm, 1980lm); 2800K, 4000K, 6000K) incl. IP44 • matte black/white</p>			 <p>5 998250 378978</p>



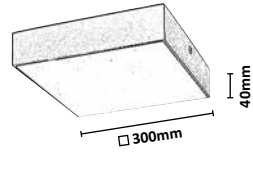

	<p>7894</p> <p>LED / 24W (2500lm, 2750lm); 2800K, 4000K, 6000K) incl. IP44 • matte white/white</p>			 <p>5 998250 378947</p>
	<p>7898</p> <p>LED / 24W (2500lm, 2750lm); 2800K, 4000K, 6000K) incl. IP44 • matte black/white</p>			 <p>5 998250 378985</p>





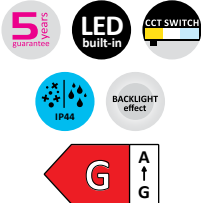
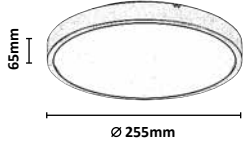

	<p>7895</p> <p>LED / 18W (1800lm, 1980lm); 2800K, 4000K, 6000K) incl. IP44 • matte white/white</p>			 <p>5 998250 378954</p>
	<p>7899</p> <p>LED / 18W (1800lm, 1980lm); 2800K, 4000K, 6000K) incl. IP44 • matte black/white</p>			 <p>5 998250 378992</p>



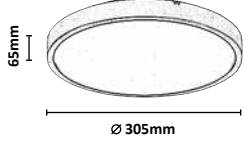

	<p>7896</p> <p>LED / 24W (2500lm, 2750lm); 2800K, 4000K, 6000K) incl. IP44 • matte white/white</p>			 <p>5 998250 378961</p>
	<p>7900</p> <p>LED / 24W (2500lm, 2750lm); 2800K, 4000K, 6000K) incl. IP44 • matte black/white</p>			 <p>5 998250 379005</p>





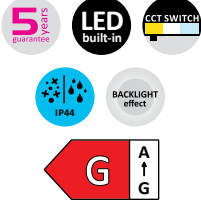
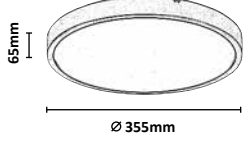





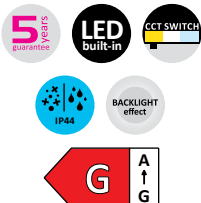
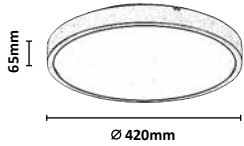



	<p>71425</p> <p>LED / 12W (1790lm, 1200lm); 3000K, 4000K, 6000K) incl. IP44 • white</p>			 <p>5 996595 714253</p>
	<p>71435</p> <p>LED / 12W (1780lm, 1200lm); 3000K, 4000K, 6000K) incl. IP44 • black/white</p>			 <p>5 996595 714352</p>







	<p>71426</p> <p>LED / 18W (1250lm, 1800lm); 3000K, 4000K, 6000K) incl. IP44 • white</p>			 <p>5 996595 714260</p>
	<p>71436</p> <p>LED / 18W (1200lm, 1800lm); 3000K, 4000K, 6000K) incl. IP44 • black/white</p>			 <p>5 996595 714369</p>

	<p>71427</p> <p>LED / 24W (1600lm, 2400lm); 3000K, 4000K, 6000K) incl. IP44 • white</p>			 <p>5 996595 714277</p>
	<p>71437</p> <p>LED / 24W (1500lm, 2400lm); 3000K, 4000K, 6000K) incl. IP44 • black/white</p>			 <p>5 996595 714376</p>







	<p>71429</p> <p>LED / 36W (2450lm, 3600lm); 3000K, 4000K, 6000K) incl. IP44 • white</p>			 <p>5 996595 714291</p>
	<p>71439</p> <p>LED / 36W (2300lm, 3600lm); 3000K, 4000K, 6000K) incl. IP44 • black/white</p>			 <p>5 996595 714390</p>



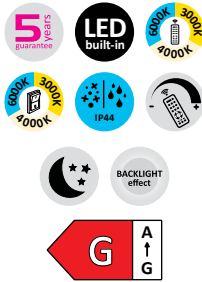
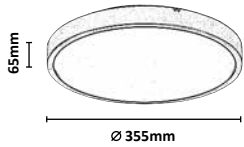



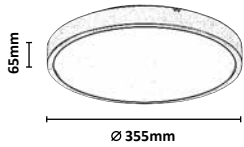



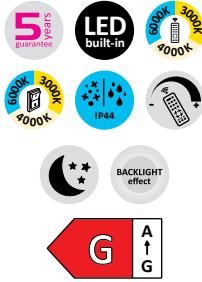
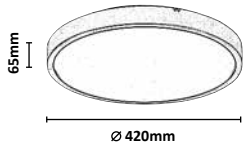

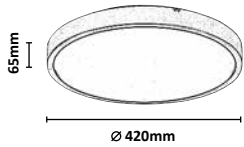

	<p>71422</p> <p>LED / 24W (☉1600lm, ☉2400lm; 3000K, 4000K, 6000K) incl. IP44 • white</p>	<p>5 years guarantee</p> <p>LED built-in</p> <p>CCT SWITCH</p> <p>IP44</p> <p>BACKLIGHT effect</p> <p>AGG</p>		 <p>5 996595 714222</p>
	<p>71432</p> <p>LED / 24W (☉1450lm, ☉2400lm; 3000K, 4000K, 6000K) incl. IP44 • black/white</p>	<p>5 years guarantee</p> <p>LED built-in</p> <p>CCT SWITCH</p> <p>IP44</p> <p>BACKLIGHT effect</p> <p>AGG</p>		 <p>5 996595 714321</p>

	<p>71423</p> <p>LED / 36W (☉2350lm, ☉3600lm; 3000K, 4000K, 6000K) incl. IP44 • white</p>	<p>5 years guarantee</p> <p>LED built-in</p> <p>CCT SWITCH</p> <p>IP44</p> <p>BACKLIGHT effect</p> <p>AGG</p>		 <p>5 996595 714239</p>
	<p>71433</p> <p>LED / 36W (☉2270lm, ☉3600lm; 3000K, 4000K, 6000K) incl. IP44 • black/white</p>	<p>5 years guarantee</p> <p>LED built-in</p> <p>CCT SWITCH</p> <p>IP44</p> <p>BACKLIGHT effect</p> <p>AGG</p>		 <p>5 996595 714338</p>

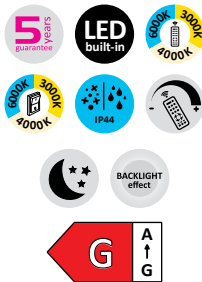





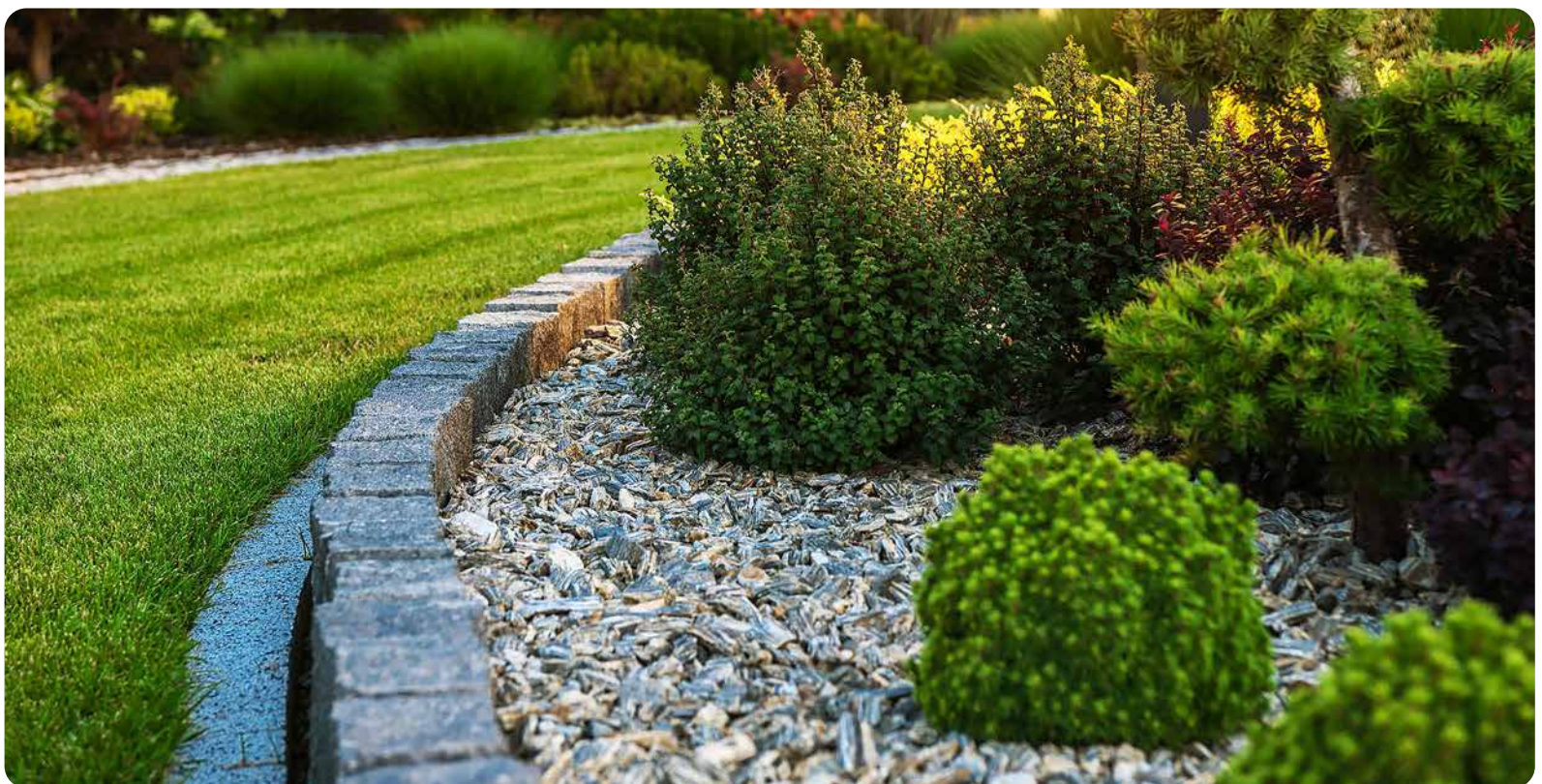

	<p>71428</p> <p>LED / 24W (21530lm, 2400lm); 3000K, 4000K, 6000K) incl. 406 • IP44 • white</p>			 <p>5 996595 714284</p>
	<p>71438</p> <p>LED / 24W (1500lm, 2400lm; 3000K, 4000K, 6000K) incl. 406 • IP44 • black/white</p>			 <p>5 996595 714383</p>





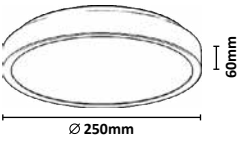

	<p>71430</p> <p>LED / 36W (2450lm, 3600lm); 3000K, 4000K, 6000K) incl. 406 • IP44 • white</p>			 <p>5 996595 714307</p>
	<p>71440</p> <p>LED / 36W (2390lm, 3600lm); 3000K, 4000K, 6000K) incl. 406 • IP44 • black/white</p>			 <p>5 996595 714406</p>





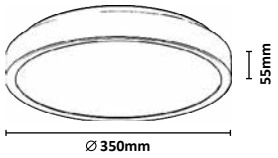

	<p>71424</p> <p>LED / 36W (2350lm, 3600lm); 3000K, 4000K, 6000K) incl. 406 • IP44 • white</p>			 <p>5 996595 714246</p>
	<p>71434</p> <p>LED / 36W (2300lm, 3600lm); 3000K, 4000K, 6000K) incl. 406 • IP44 • black/white</p>			 <p>5 996595 714345</p>



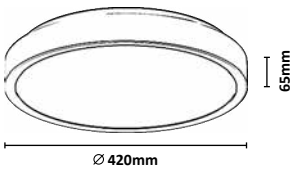

	<p>71252</p> <p>LED / 18W (☉1380lm, ☉1800lm; 4000K) incl. • IP44 black/white</p>			 <p>5 996595 712525</p>
	<p>71257</p> <p>LED / 18W (☉1400lm, ☉1800lm; 4000K) incl. • IP44 white</p>			 <p>5 996595 712570</p>





	<p>71253</p> <p>LED / 36W (☉2900lm, ☉3600lm; 4000K) incl. • IP44 black/white</p>			 <p>5 996595 712532</p>
	<p>71258</p> <p>LED / 36W (☉2930lm, ☉3600lm; 4000K) incl. • IP44 white</p>			 <p>5 996595 712587</p>



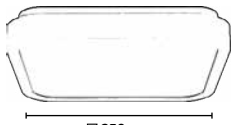

	<p>71254</p> <p>LED / 48W (☉3100lm, ☉4800lm; 4000K) incl. • IP44 black/white</p>			 <p>5 996595 712549</p>
	<p>71259</p> <p>LED / 48W (☉3150lm, ☉4800lm; 4000K) incl. • IP44 white</p>			 <p>5 996595 712594</p>



SAMIRA

P

	<p>71255</p> <p>LED / 18W (☉1400lm, ☉1800lm; 4000K) incl. • IP44 black/white</p>	<p>5 years guarantee</p> <p>LED built-in</p> <p>NATURAL White</p> <p>IP44</p> <p>BACKLIGHT effect</p> <p>AGG</p>	 <p>60mm</p> <p>□ 250mm</p>	 <p>5 996595 712556</p>
	<p>71260</p> <p>LED / 18W (☉1430lm, ☉1800lm; 4000K) incl. • IP44 white</p>			 <p>5 996595 712600</p>

	<p>71256</p> <p>LED / 48W (☉3100lm, ☉4800lm; 4000K) incl. • IP44 black/white</p>	<p>5 years guarantee</p> <p>LED built-in</p> <p>NATURAL White</p> <p>IP44</p> <p>BACKLIGHT effect</p> <p>AGG</p>	 <p>60mm</p> <p>□ 420mm</p>	 <p>5 996595 712563</p>
	<p>71261</p> <p>LED / 48W (☉3150lm, ☉4800lm; 4000K) incl. • IP44 white</p>			 <p>5 996595 712617</p>





































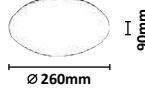

	<p>771B3</p> <p>LED / 12W (☉) 750lm; (☉) 1200lm, 3000K, 4000K, 6000K) incl. IP44 • white</p>			 <p>5 996595 771331</p>
	<p>771B4</p> <p>LED / 12W (☉) 750lm; (☉) 1200lm, 3000K, 4000K, 6000K) incl. IP44 • white</p>			 <p>5 996595 771348</p>
	<p>771B5</p> <p>LED / 36W (☉) 2300lm; (☉) 3600lm, 3000K, 4000K, 6000K) incl. IP44 • white</p>			 <p>5 996595 771355</p>
	<p>771B6</p> <p>LED / 36W (☉) 2300lm; (☉) 3600lm, 3000K, 4000K, 6000K) incl. IP44 • white</p>			 <p>5 996595 771362</p>
	<p>77182</p> <p>LED / 18W (☉) 1100lm; (☉) 1800lm, 3000K, 4000K, 6000K) incl. IP44 • white</p>			 <p>5 996595 771829</p>
	<p>77181</p> <p>LED / 18W (☉) 1100lm; (☉) 1800lm, 3000K, 4000K, 6000K) incl. IP44 • white</p>			 <p>5 996595 771812</p>







	<p>71504 - Lucas2</p> <p>LED / 12W (1050lm, 1200lm); 4000K incl. • IP44 20200 • white</p>			 <p>5 996595 715045</p>
	<p>71505 - Lucas2</p> <p>LED / 18W (1450lm, 1800lm); 4000K incl. • IP44 20201 • white</p>			 <p>5 996595 715052</p>
	<p>71506 - Lucas2</p> <p>LED / 24W (1850lm, 2400lm); 4000K incl. • IP44 20202 • white</p>			 <p>5 996595 715069</p>
	<p>71510 - Lucas2</p> <p>LED / 12W (1150lm, 1200lm); 4000K incl. • IP44 20206 • white</p>			 <p>5 996595 715106</p>
	<p>71511 - Lucas2</p> <p>LED / 18W (1460lm, 1800lm); 4000K incl. • IP44 20207 • white</p>			 <p>5 996595 715113</p>
	<p>71512 - Lucas2</p> <p>LED / 24W (1970lm, 2400lm); 4000K incl. • IP44 20208 • white</p>			 <p>5 996595 715120</p>
	<p>3437 - Lucas</p> <p>LED / 12W (900lm, 4000K) incl. IP44 • 19714 white</p>			 <p>5 998250 334370</p>
	<p>3438 - Lucas</p> <p>LED / 18W (1350lm, 4000K) incl. IP44 • 19715 white</p>			 <p>5 998250 334387</p>
	<p>3439 - Lucas</p> <p>LED / 24W (1800lm, 4000K) incl. IP44 • 19716 white</p>			 <p>5 998250 334394</p>

GAELO



75025



75026

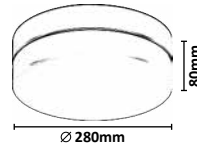

ZENON



2697



2698

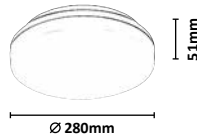

ERIC



7979

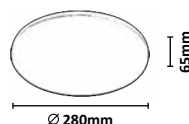

75025, 75026



75025 (M P)

LED / 15W
(1150lm, 1500lm;
4000K) incl. • IP44 • 20098
black/white



5 996595 750251

75026 (M P)

LED / 18W
(1370lm, 1820lm;
4000K) incl. • IP44 • 20094
black/white



5 996595 750268

2697 (P)

LED / 18W
(1450lm, 1880lm;
3000K, 4000K, 6000K) incl.
IP54 • white



5 998250 326979

2698 (P)

LED / 24W
(2100lm, 2565lm;
3000K, 4000K, 6000K) incl.
IP54 • white



5 998250 326986

7979 (P)

LED / 24W
(2160lm, 3252lm;
4000K) incl. • IP64
white



5 998250 379791



LARCIA



75009

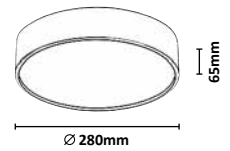

75010

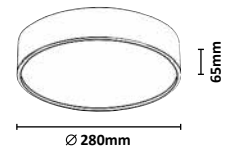

75009 **P**

LED / 18W
(970lm, 1800lm;
4000K) incl. • IP44 • 19992
black/white



75010 **P**

LED / 18W
(1060lm, 1800lm;
4000K) incl. • IP44 • 19134
silver/white



STUTT GART



79112



8683

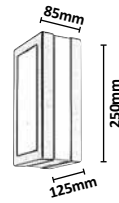

8684

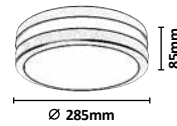

8685

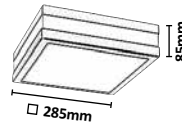

8683 **M P**

☒ E27 / 1x max. 14W
IP44
anthracite/white



5 998250 386836

8684 **M P**

☒ E27 / 2x max. 11W
IP44
anthracite/white















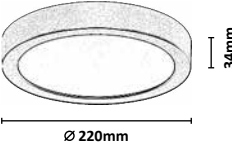

5 998250 386843

8685 **M P**

☒ E27 / 2x max. 11W
IP44
anthracite/white

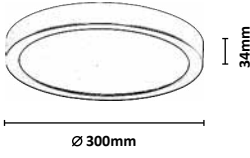

5 998250 386850

	<p>75071</p> <p>LED / 7W (3660lm, 3710lm; 4000K) incl. • IP44 white</p>	<p>5 years guarantee</p> <p>LED built-in</p> <p>NATURAL White</p> <p>IP44</p> <p>F A ↑ G</p> <p>New</p>	 <p>34mm</p> <p>Ø 120mm</p>	 <p>5 996595 750718</p>
	<p>75074</p> <p>LED / 7W (3660lm, 3710lm; 4000K) incl. • IP44 black/white</p>			 <p>5 996595 750749</p>
	<p>75077</p> <p>LED / 7W (3660lm, 3710lm; 4000K) incl. • IP44 gold/white</p>			 <p>5 996595 750770</p>
	<p>75072</p> <p>LED / 24W (2600lm, 2800lm; 4000K) incl. • IP44 white</p>	<p>5 years guarantee</p> <p>LED built-in</p> <p>NATURAL White</p> <p>IP44</p> <p>F A ↑ G</p> <p>New</p>	 <p>34mm</p> <p>Ø 220mm</p>	 <p>5 996595 750725</p>
	<p>75075</p> <p>LED / 24W (2600lm, 2800lm; 4000K) incl. • IP44 black/white</p>			 <p>5 996595 750756</p>
	<p>75078</p> <p>LED / 24W (2600lm, 2800lm; 4000K) incl. • IP44 gold/white</p>			 <p>5 996595 750787</p>
	<p>75073</p> <p>LED / 30W (3000lm, 3250lm; 4000K) incl. • IP44 white</p>	<p>5 years guarantee</p> <p>LED built-in</p> <p>NATURAL White</p> <p>IP44</p> <p>F A ↑ G</p> <p>New</p>	 <p>34mm</p> <p>Ø 300mm</p>	 <p>5 996595 750732</p>
	<p>75076</p> <p>LED / 30W (3000lm, 3250lm; 4000K) incl. • IP44 black/white</p>			 <p>5 996595 750763</p>
	<p>75079</p> <p>LED / 30W (3000lm, 3250lm; 4000K) incl. • IP44 gold/white</p>			 <p>5 996595 750794</p>



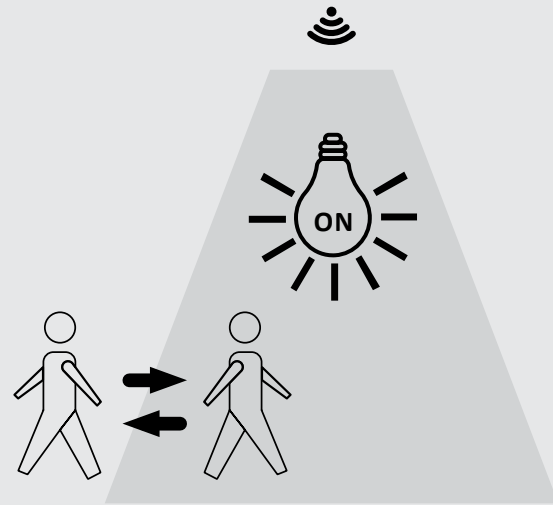
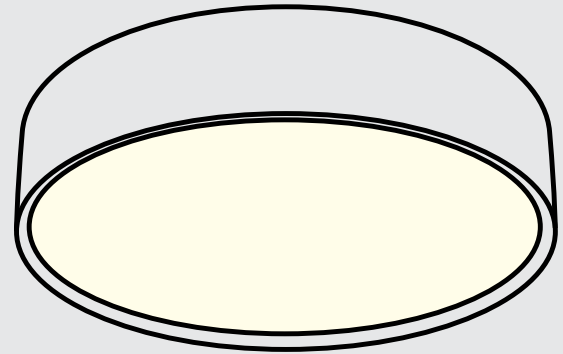
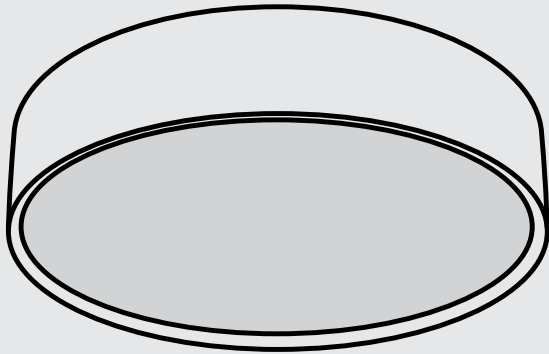

adjustable • állítható • einstellbar

	1	2	Detection Area	3	4	5	Hold Time	6	7	8	Daylight Sensor
I	ON	ON	100%	ON	ON	ON	5s	ON	ON	ON	2Lux
II	ON	-	75%	ON	ON	-	30s	ON	ON	-	10Lux
III	-	ON	50%	ON	-	ON	1min	-	ON	-	25Lux
IV	-	-	25%	ON	-	-	3min	ON	-	-	50Lux
V				-	ON	ON	5min	-	-	-	Disable
VI				-	ON	-	10min				
VII				-	-	ON	20min				
VIII				-	-	-	30min				

LARCIA



75011

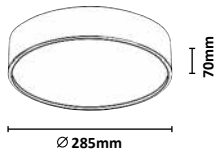

75012

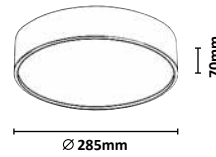

LUCAS



71132



71133

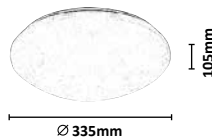

71134

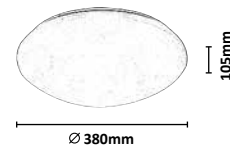

75011 (P)

LED / 19W
 (1000lm, 1900lm;
 4000K) incl. • IP44 • 6m, 120°
 20010 • black/white



5 996595 750114

75012 (P)

LED / 19W
 (1070lm, 1900lm;
 4000K) incl. • IP44 • 6m, 120°
 20011 • white



5 996595 750121

71132 (M P)

LED / 12W
 (830lm, 1200lm;
 4000K) incl. • IP44 • 6m, 120°
 19714 • white



5 996595 711320

71133 (M P)

LED / 18W
 (1180lm, 1800lm;
 4000K) incl. • IP44 • 6m, 120°
 19715 • white



5 996595 711337

71134 (M P)

LED / 24W
 (1750lm, 2400lm;
 4000K) incl. • IP44 • 6m, 120°
 19716 • white



5 996595 711344



LOWAR



77137

WARM White



77138

NATURAL White



77139

WARM White

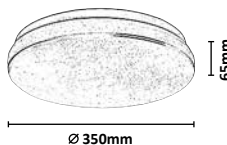

77140

NATURAL White

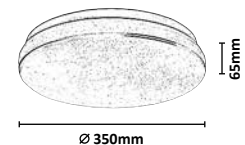

77137

(P)

LED / 18W
 (☰) 1150lm; (☲) 1800lm,
 3000K incl. • IP44
 ☰ 5m, 360° • white



5 996595 771379

77138

(P)

LED / 18W
 (☰) 1150lm; (☲) 1800lm,
 4000K incl. • IP44
 ☰ 5m, 360° • white



5 996595 771386

77139

(P)

LED / 24W
 (☰) 1450lm; (☲) 2400lm,
 3000K incl. • IP44
 ☰ 5m, 360° • white



5 996595 771393

77140

(P)

LED / 24W
 (☰) 1450lm; (☲) 2400lm,
 4000K incl. • IP44
 ☰ 5m, 360° • white



5 996595 771409



For sensor-based Lowar products the sensor is operated via a remote control. See the image for remote control usage.

Szenzoros Lowar termékek esetén a szenzor kapcsolása távirányítóval történik. A távirányító használatát lásd a képen.

Bei sensorbasierten Lowar-Produkten wird der Sensor über eine Fernbedienung gesteuert. Die Nutzung der Fernbedienung ist auf dem Bild ersichtlich.

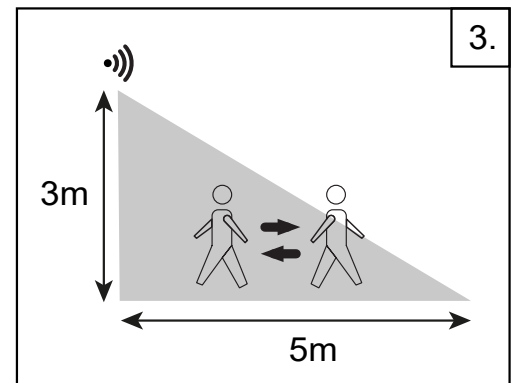
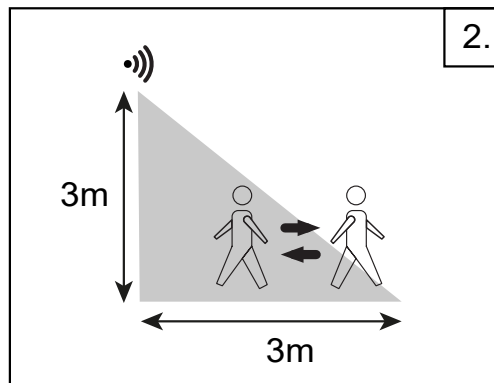
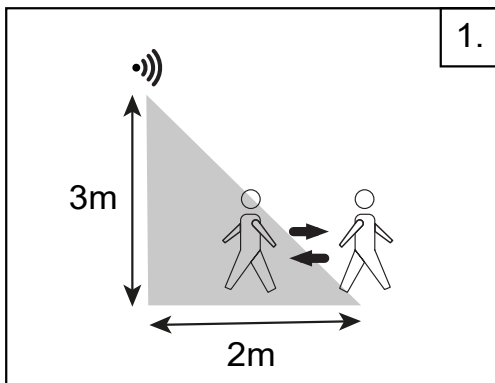
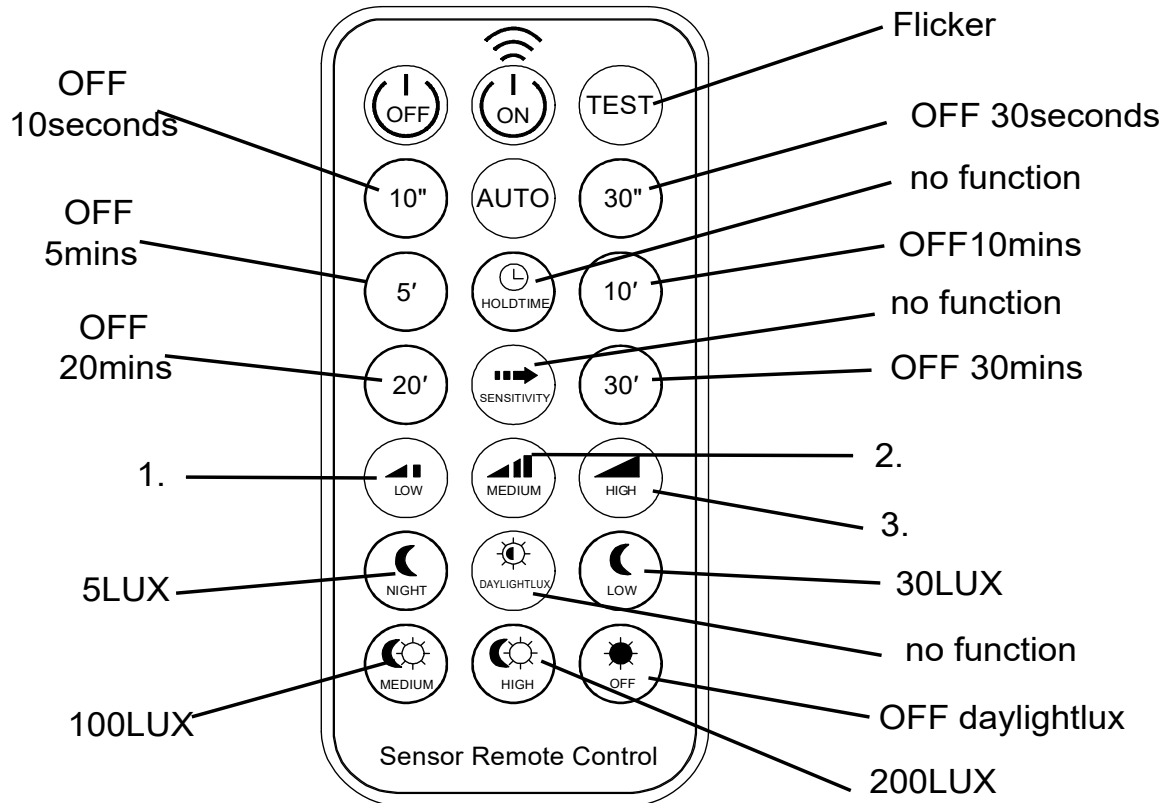



LONATO



77213

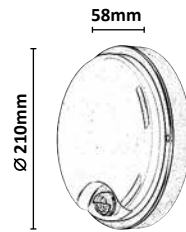

77214

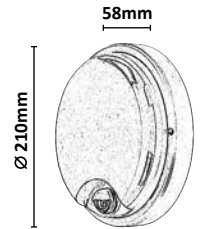

HITURA



77028

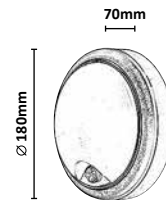

77029

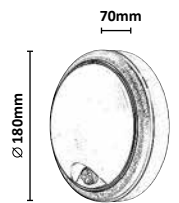

77213



LED / 18W
 (1730lm, 2500lm; 4000K) incl.
 IP65 • 8m, 120°
 black/white



5 996595 772130

77214



LED / 18W
 (1730lm, 2500lm; 4000K) incl.
 IP65 • 8m, 120°
 white



5 996595 772147

77028



LED / 15W
 (1350lm, 1800lm; 4000K) incl.
 IP54 • 6±2m, 120°
 black/white



5 996595 770280

77029



LED / 15W
 (1500lm, 1800lm; 4000K) incl.
 IP54 • 6±2m, 120°
 white



5 996595 770297

HORT



LENTIL



7406

(P)

LED / 15W
 (1300lm, 1490lm;
 4000K) incl. • IP54
 white



5 998250 374062

7407

(P)

LED / 15W
 (1100lm, 1350lm;
 4000K) incl. • IP54
 black/white



5 998250 374079

7408

(P)

LED / 15W
 (1300lm, 1490lm;
 4000K) incl. • IP54
 white



5 998250 374086

7409

(P)

LED / 15W
 (1100lm, 1350lm;
 4000K) incl. • IP54
 black/white



5 998250 374093

5810

(P)

E27 / 1x max. 60W
 IP54
 white



5 998250 358109



AMARILLO



7969

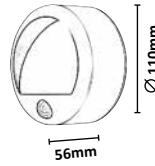

7980



TRENTO



8893

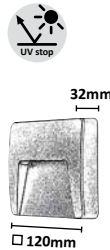

8894

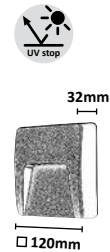

77105

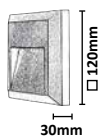

7969



☑ DC 4,5V / LED / 1,5W
 (☑50lm, ☑90lm; 3000K) incl.
 3xAAA excl. • IP44
 ☑ 2-8m, 90° • black/white



5 998250 379692

7980



☑ DC 4,5V / LED / 1,5W
 (☑50lm, ☑90lm; 3000K) incl.
 3xAAA excl. • IP44
 ☑ 2-8m, 90° • white



5 998250 379807

8893



☑ LED / 3W
 (☑100lm, ☑200lm;
 4000K) incl. • IP65
 white



5 998250 388939

8894



☑ LED / 3W
 (☑100lm, ☑200lm;
 4000K) incl. • IP65
 anthracite



5 998250 388946

77105



☑ LED / 4W
 (☑180lm, ☑400lm;
 4000K) incl. • IP65
 anthracite/transparent



5 996595 771058

KAVALA



77189

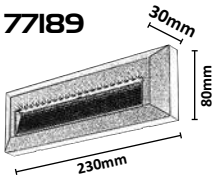

77190

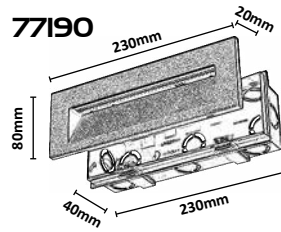

PUEBLO



8011

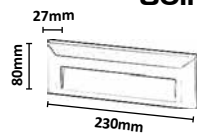

TACOMA



8714

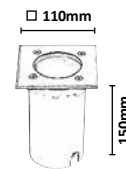

77189



LED / 6W
(300lm, 600lm;
3000K, 4000K, 6500K) incl. • IP65
black/transparent



5 996595 771898

77190



LED / 6W
(250lm, 600lm;
3000K, 4000K, 6500K) incl. • IP65
black/transparent



5 996595 771904

8011



LED / 1,6W
(103lm, 160lm;
4000K) incl. • IP65
grey



5 998250 380117

8714



GU10 / 1x max. 50W
IP65
satin chrome



5 998250 387147

A dark, textured background of a stone wall with irregular, layered stones in shades of dark brown and black. The lighting creates subtle highlights and shadows, emphasizing the rough, natural texture of the masonry.

03

CLASSIC PRODUCT FAMILIES

KLASSZIKUS TERMÉKCSALÁDOK

KLASSISCHE PRODUKTFAMILIEN



MONACO



8181



8184

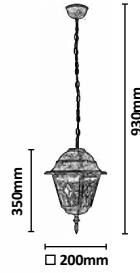

8182

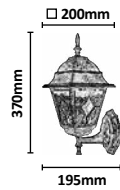

8185



8186

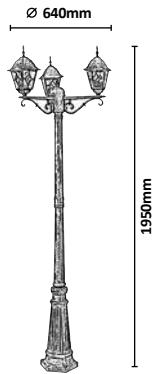

8181

M G

☒ E27 / 1x max. 60W
IP43 • 19053
antique gold/multicolour



5 998250 381817

8182

M G

☒ E27 / 1x max. 60W
IP43 • 19053
antique gold/multicolour



5 998250 381824

8184

M G

☒ E27 / 1x max. 60W
IP43 • 19053
antique gold/multicolour



5 998250 381848

8185

M G

☒ E27 / 1x max. 60W
IP43 • 19053
antique gold/multicolour



5 998250 381855

8186

M G

☒ E27 / 3x max. 60W
IP43 • 19053
antique gold/multicolour



5 998250 381862

TORONTO



8381

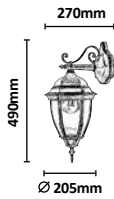

8460

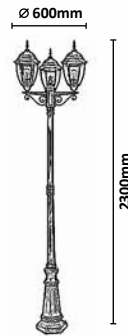

8381



☒ E27 / 1x max. 60W
IP44 • 9801
antique gold/transparent



5 998250 383811

8460



☒ E27 / 3x max. 60W
IP44 • 9801
antique gold/transparent



5 998250 384603



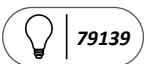

8370

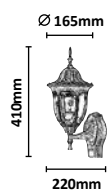

8376

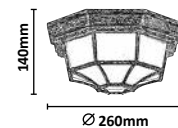

8371

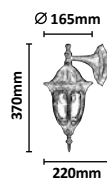

8372



8370 **M G**

☒ E27 / 1x max. 60W
IP43 • 9449
☒ 8m, 120°
antique gold/transparent



5 998250 383705

8371 **M G**

☒ E27 / 1x max. 60W
IP43 • 9449
antique gold/transparent



5 998250 383712

8372 **M G**

☒ E27 / 1x max. 60W
IP43 • 9449
antique gold/transparent



5 998250 383729

8376 **M G**

☒ E27 / 1x max. 100W
IP43 • 9446
antique gold/transparent



5 998250 383767

MILANO



8373



8374

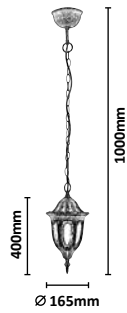

8375



8373 **MG**

☒ E27 / 1x max. 60W
IP43 • 9449
antique gold/transparent



5 998250 383736

8374 **MG**

☒ E27 / 1x max. 60W
IP43 • 9449
antique gold/transparent



5 998250 383743

8375 **MG**

☒ E27 / 1x max. 60W
IP43 • 9449
antique gold/transparent



5 998250 383750

MILANO



7837



8346

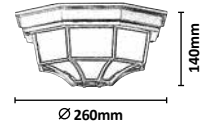

8341



8344

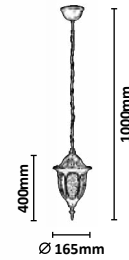

8342



8345

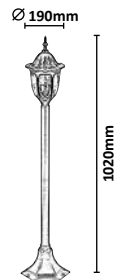

7837 **MG**

☒ E27 / 1x max. 60W
IP43 • 9449
8m, 120°
black/transparent



5 998250 378374

8341 **MG**

☒ E27 / 1x max. 60W
IP43 • 9449
black/transparent



5 998250 383415

8342 **MG**

☒ E27 / 1x max. 60W
IP43 • 9449
black/transparent



5 998250 383422

8344 **MG**

☒ E27 / 1x max. 60W
IP43 • 9449
black/transparent



5 998250 383446

8345 **MG**

☒ E27 / 1x max. 60W
IP43 • 9449
black/transparent



5 998250 383453

8346 **MG**

☒ E27 / 1x max. 100W
IP43 • 9446
black/transparent



5 998250 383460

VELENCE



8204

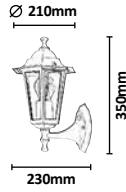

8202



8206

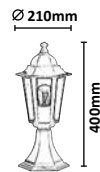

8208

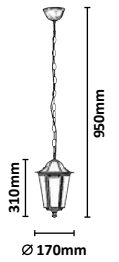

8217

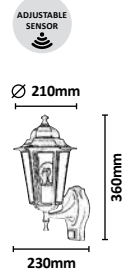

8210

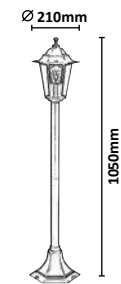

8202 **M G**

☒ E27 / 1x max. 60W
IP43 • 9283
black/transparent



5 998250 382029

8204 **M G**

☒ E27 / 1x max. 60W
IP43 • 9283
black/transparent



5 998250 382043

8206 **M G**

☒ E27 / 1x max. 60W
IP43 • 9283
black/transparent



5 998250 382067

8208 **M G**

☒ E27 / 1x max. 60W
IP43 • 9283
black/transparent



5 998250 382081

8210 **M G**

☒ E27 / 1x max. 60W
IP43 • 9283
black/transparent



5 998250 382104

8217 **M G**

☒ E27 / 1x max. 60W
IP43 • 9283
8m, 120°
black/transparent



5 998250 382173

VELENCE



8203

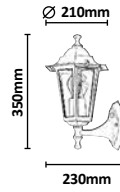

8201

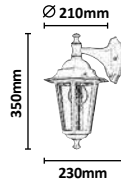

8205

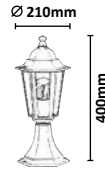

8207

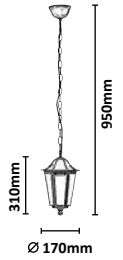

8216

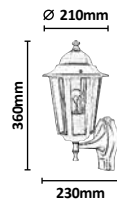

8209

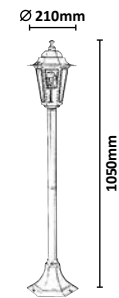

8201 (M) (G)

☒ E27 / 1x max. 60W
IP43 • 9283
white/transparent



5 998250 382012

8203 (M) (G)

☒ E27 / 1x max. 60W
IP43 • 9283
white/transparent



5 998250 382036

8205 (M) (G)

☒ E27 / 1x max. 60W
IP43 • 9283
white/transparent



5 998250 382050

8207 (M) (G)

☒ E27 / 1x max. 60W
IP43 • 9283
white/transparent



5 998250 382074

8209 (M) (G)

☒ E27 / 1x max. 60W
IP43 • 9283
white/transparent



5 998250 382098

8216 (M) (G)

☒ E27 / 1x max. 60W
IP43 • 9283
8m, 120°
white/transparent



5 998250 382166

VELENCE



8234

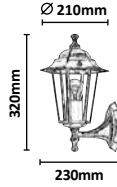

8218



8236

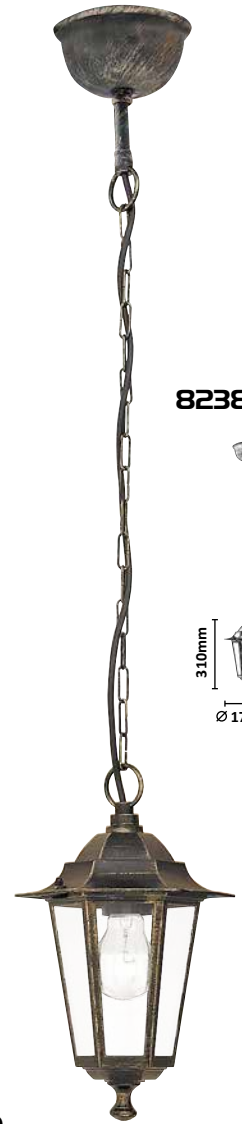

8238

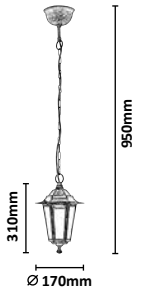

8232

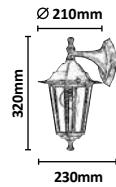

8240

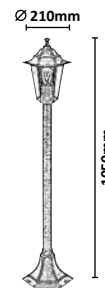

8218 **M G**

☒ E27 / 1x max. 60W
IP43 • 9283
☒ 8m, 120°
antique gold/transparent



5 998250 382180

8232 **M G**

☒ E27 / 1x max. 60W
IP43 • 9283
antique gold/transparent



5 998250 382326

8234 **M G**

☒ E27 / 1x max. 60W
IP43 • 9283
antique gold/transparent



5 998250 382340

8236 **M G**

☒ E27 / 1x max. 60W
IP43 • 9283
antique gold/transparent



5 998250 382364

8238 **M G**

☒ E27 / 1x max. 60W
IP43 • 9283
antique gold/transparent



5 998250 382388

8240 **M G**

☒ E27 / 1x max. 60W
IP43 • 9283
antique gold/transparent



5 998250 382401

TOSCANA

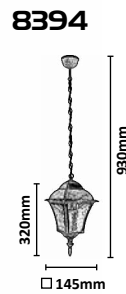
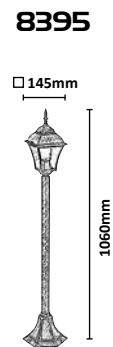
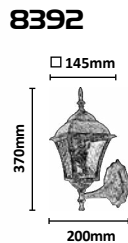
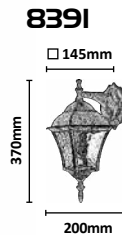
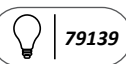

8391 **MG**

☒ E27 / 1x max. 60W
IP43 • 19052
antique gold/transparent



8392 **MG**

☒ E27 / 1x max. 60W
IP43 • 19052
antique gold/transparent



8394 **MG**

☒ E27 / 1x max. 60W
IP43 • 19052
antique gold/transparent



8395 **MG**

☒ E27 / 1x max. 60W
IP43 • 19052
antique gold/transparent



ODESSA

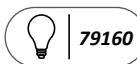

8163



8165



8164



8163 (M) (P)

☒ E27 / 1x max. 60W
IP44 • 19447
antique brown/transparent



5 998250 381633

8164 (M) (P)

☒ E27 / 1x max. 60W
IP44 • 19447
antique brown/transparent



5 998250 381640

8165 (M) (P)

☒ E27 / 1x max. 60W
IP44 • 19447
antique brown/transparent



5 998250 381657

MADRID

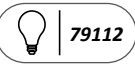

8476

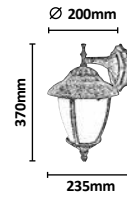

7836



8377

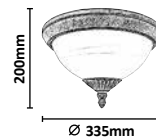

7836 **MG**

☒ E27 / 1x max. 60W
IP43 • 9865
8m, 120°
antique gold/alabaster



5 998250 378367

8377 **MG**

☒ E27 / 2x max. 40W
IP43 • 9866
antique gold/alabaster



5 998250 383774

8476 **MG**

☒ E27 / 1x max. 60W
IP43 • 9865
antique gold/alabaster



5 998250 384764

MADRID



8480

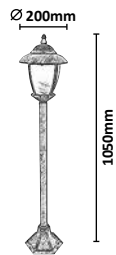

8379

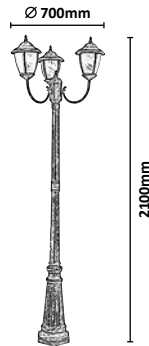

8379 **MG**

☒ E27 / 3x max. 60W
IP43 • 9865
antique gold/alabaster



5 998250 383798

8480 **MG**

☒ E27 / 1x max. 60W
IP43 • 9865
antique gold/alabaster



5 998250 384801

OSLO



8737



8271

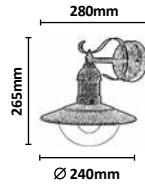

8736

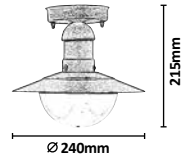

8739



8681

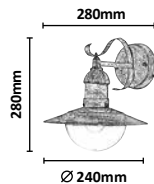

8740



8271 (M) (P)
 ☒ E27 / 1x max. 60W
 IP44 • 19050
 antique gold/transparent



5 998250 382715

8681 (M) (P)
 ☒ E27 / 1x max. 60W
 IP44 • 19050
 antique white/transparent



5 998250 386812

8736 (M) (P)
 ☒ E27 / 1x max. 60W
 IP44 • 19050
 antique gold/transparent



5 998250 387369

8737 (M) (P)
 ☒ E27 / 1x max. 60W
 IP44 • 19050
 antique gold/transparent



5 998250 387376

8739 (M) (P)
 ☒ E27 / 1x max. 60W
 IP44 • 19050
 antique white/transparent



5 998250 387390

8740 (M) (P)
 ☒ E27 / 1x max. 60W
 IP44 • 19050
 antique white/transparent



5 998250 387406

OSLO



YAGO



8270

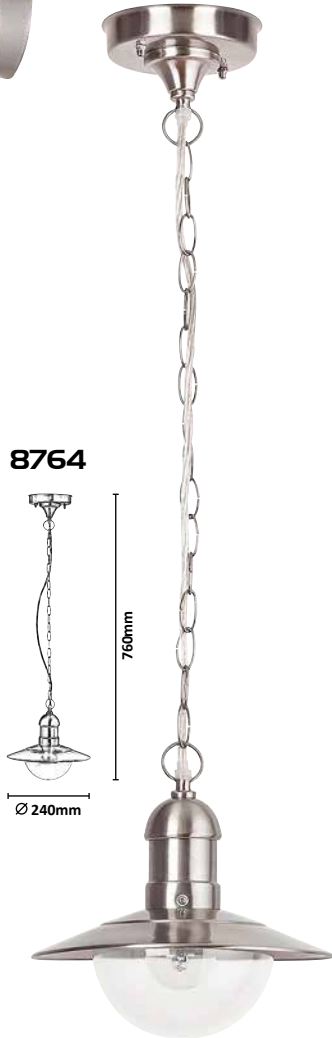
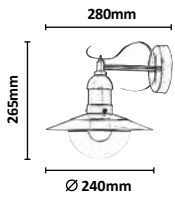

8764

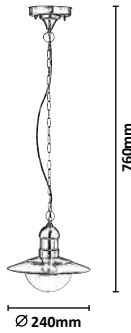

3309

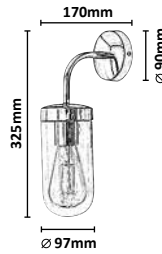

8763

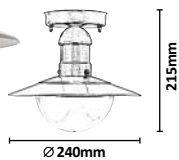

8270 **M P**

☒ E27 / 1x max. 60W
IP44 • 19050
satin chrome/transparent



5 998250 382708

8763 **M P**

☒ E27 / 1x max. 60W
IP44 • 19050
satin chrome/transparent



5 998250 387635

8764 **M P**

☒ E27 / 1x max. 60W
IP44 • 19050
satin chrome/transparent



5 998250 387642

3309 **M G**

☒ E27 / 1x max. 60W
IP44 • 19984
chrome/transparent



5 998250 333090

OSLO



8680

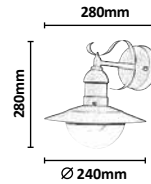

8682

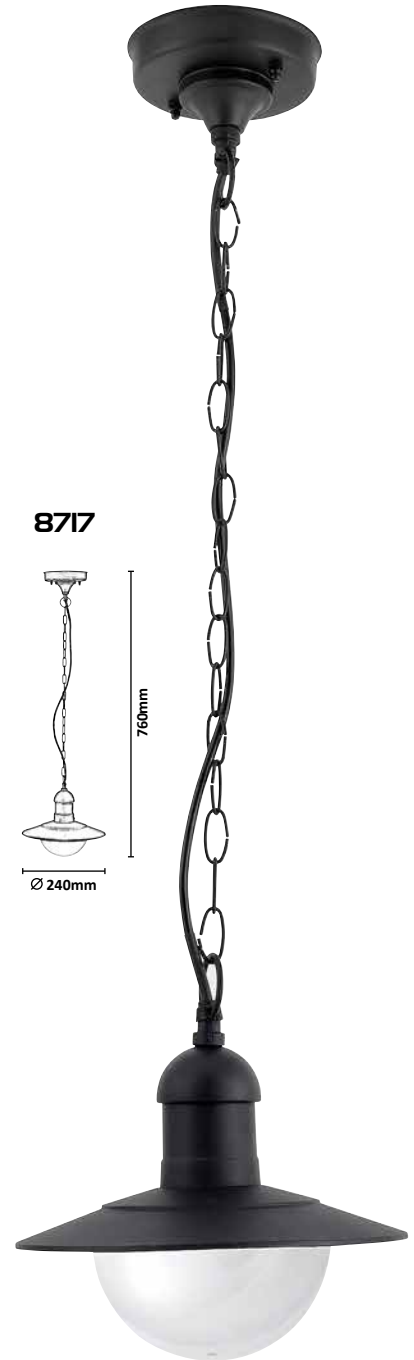
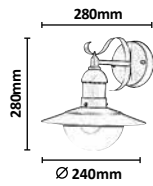

8717

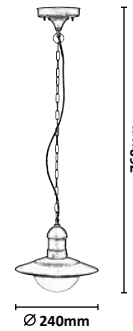

8716

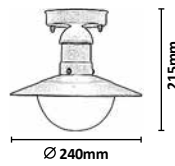

8680 (M) (P)

☒ E27 / 1x max. 60W
IP44 • 19050
black/transparent



5 998250 386805

8682 (M) (P)

☒ E27 / 1x max. 60W
IP44 • 19050
green/transparent



5 998250 386829

8716 (M) (P)

☒ E27 / 1x max. 60W
IP44 • 19050
black/transparent



5 998250 387161

8717 (M) (P)

☒ E27 / 1x max. 60W
IP44 • 19050
black/transparent



5 998250 387178

VIGO



8686

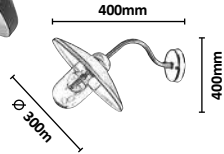

8687

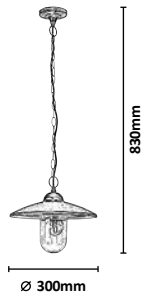

8686 **M G**

☒ E27 / 1x max. 60W
IP44 • 19446
matte black/transparent



5 998250 386867

8687 **M G**

☒ E27 / 1x max. 60W
IP44 • 19446
matte black/transparent



5 998250 386874





DARIUS



8190

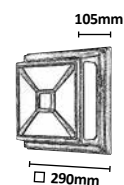

HEKTOR



8496

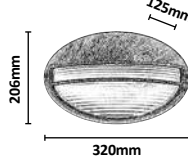

8499

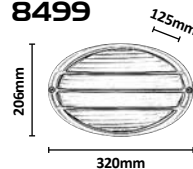

8190 (M) (P)

☒ E27 / 2x max. 60W
IP54
antique gold/white



8496 (M) (G)

☒ E27 / 1x max. 100W
IP54 • 9282
antique gold/transparent



8499 (M) (G)

☒ E27 / 1x max. 100W
IP54 • 9282
antique gold/transparent



HAGA



8244

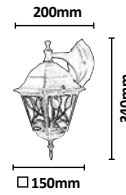

NORVICH



8753



8754



8244



8244 (M) (G)

☒ E27 / 1x max. 100W
IP44 • 19187
antique gold/transparent



5 998250 382449

8753 (M) (G)

☒ E27 / 1x max. 60W
IP43
19524 • 19523
antique white/transparent



5 998250 387536

8754 (M) (G)

☒ E27 / 1x max. 60W
IP43
19524 • 19523
antique gold/transparent



5 998250 387543

04

**TABLE, DECORATIVE
AND SOLAR LAMPS**

ASZTALI, DEKOR, ÉS NAPELEMES LÁMPÁK

TISCH-, DEKOR- UND SOLARLAMPEN



77146, 77147



POLPERRO



77146

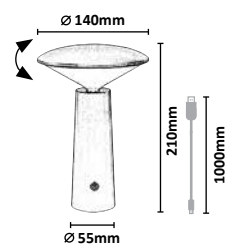

77147

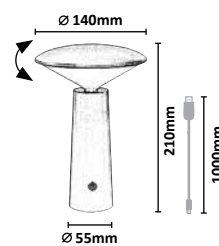

77146



DC 5V / LED / 3W (180lm, 250lm; 2800K, 4000K, 6500K) incl. • IP20
DC 3,7V 1200mAh incl.
white



5 996595 771461

77147



DC 5V / LED / 3W (180lm, 250lm; 2800K, 4000K, 6500K) incl. • IP20
DC 3,7V 1200mAh incl.
black/white



5 996595 771478

MIREO



76036

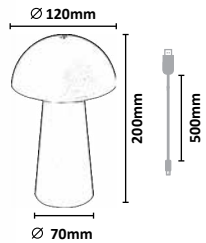

76038

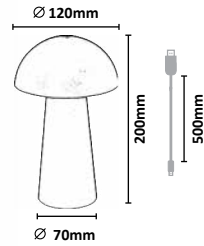

76037

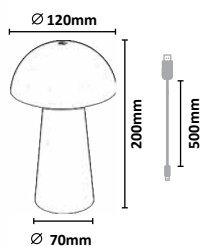

76039

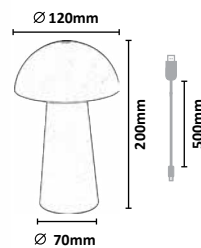

Charging time: 4h
Working time: 5h

76036



DC 5V / LED 1,5W
(60lm, 150lm; 3000K) • IP44
DC 3,7V 1200mAh incl.
5h • black



5 996595 760366

76037



DC 5V / LED 1,5W
(60lm, 150lm; 3000K) • IP44
DC 3,7V 1200mAh incl.
5h • white



5 996595 760373

76038



DC 5V / LED 1,5W
(60lm, 150lm; 3000K) • IP44
DC 3,7V 1200mAh incl.
5h • green



5 996595 760380

76039



DC 5V / LED 1,5W
(60lm, 150lm; 3000K) • IP44
DC 3,7V 1200mAh incl.
5h • brown



5 996595 760397

77143, 77144, 77145



FUNES



77143

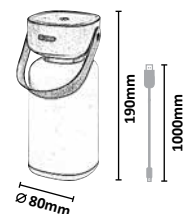

77144

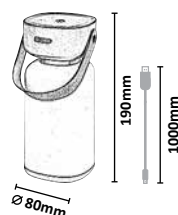

77145

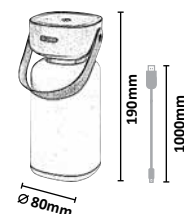

77143



DC 5V / LED / 3W (120lm, 150lm; 2800K, 4000K, 6500K) incl. • IP44
DC 3,7V 120mAh incl.
brown/white



5 996595 771430

77144



DC 5V / LED / 3W (120lm, 150lm; 2800K, 4000K, 6500K) incl. • IP44
DC 3,7V 120mAh incl.
green/white



5 996595 771447

77145



DC 5V / LED / 3W (120lm, 150lm; 2800K, 4000K, 6500K) incl. • IP44
DC 3,7V 120mAh incl.
blue/white



5 996595 771454

ODERA



7040

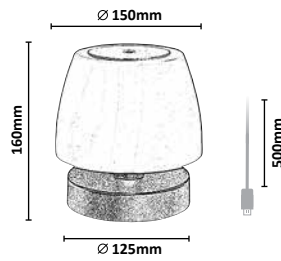

7040



BURDUR



77142

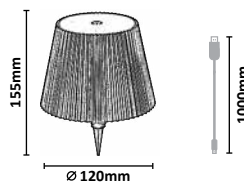

77142



7040



DC 5V / LED / 3W
 (140lm, 360lm; 3000K) incl.
 DC 3,7V 2000mAh incl. • IP44
 black/white



5 998250 370408

77142



DC 5V / LED / 2W
 (180lm, 270lm; 3000K) incl.
 DC 3,7V 2000mAh incl. • IP44
 black/transparent



5 996595 771423

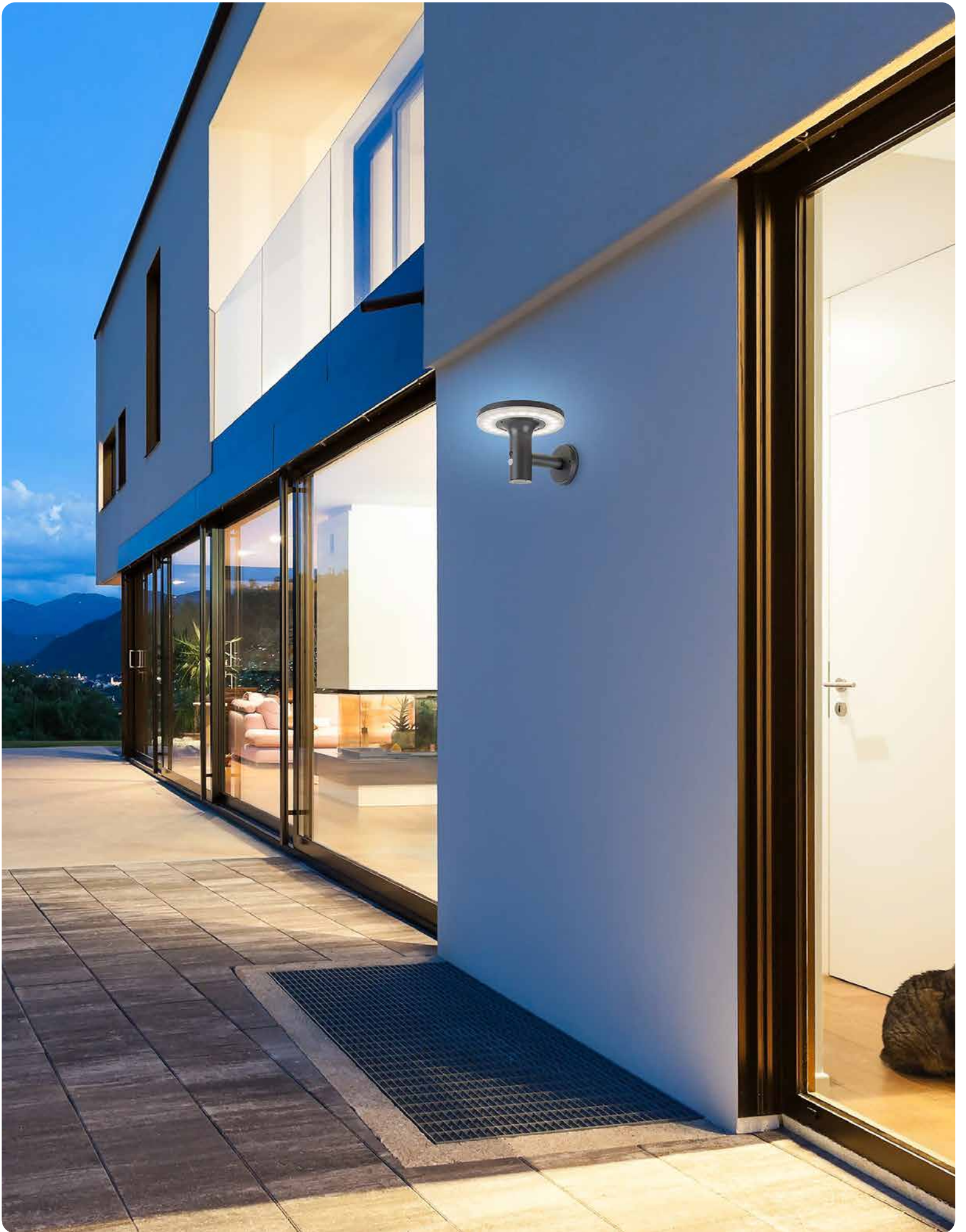

ALASKA



77017

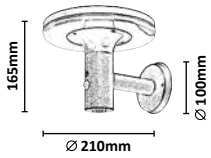

77018

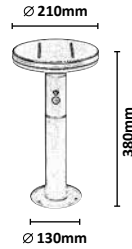

LASSET



77078

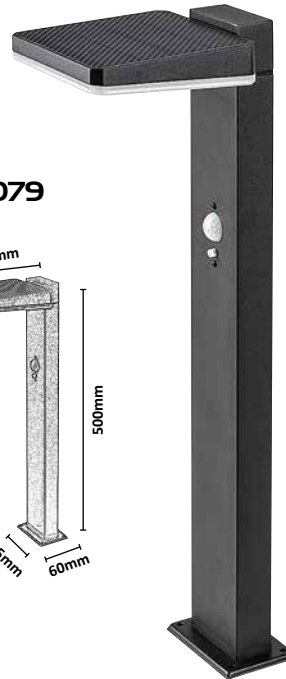
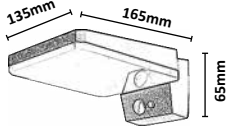

77079

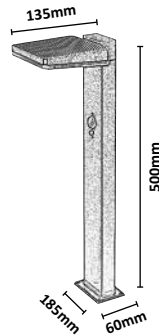

77017 **(M P)**

LED / 10W (250lm, 300lm; 4000K) incl. DC 3,7V 2500mAh incl. IP44 • 5-8m, 120° anthracite/white



5 996595 770174

77018 **(M P)**

LED / 10W (250lm, 300lm; 4000K) incl. DC 3,7V 2500mAh incl. IP44 • 5-8m, 120° anthracite/white



5 996595 770181

77078 **(M P)**

LED / 4,4W (200lm, 600lm; 4000K) incl. • IP54 • 8m, 110° DC 3,7V 2200mAh black/white



5 996595 770785

77079 **(M P)**

LED / 4,4W (200lm, 600lm; 4000K) incl. • IP54 • 8-12m, 110° DC 3,7V 2200mAh black/white



5 996595 770792

MOSELLE



77014

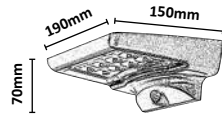

QESA



77005



KANGTON



77024

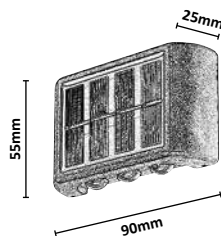

LERMOS



77203

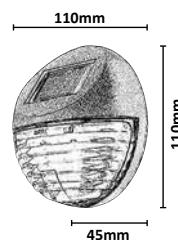

NARMADA



77004

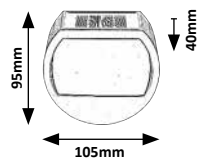

77014 P

LED / 4W (300lm, 350lm; 4000K) incl. • DC 3,7V 15000mAh incl. IP44 • 5-8m, 120° black/white



5 996595 770143

77005 P

LED / 10W (460lm, 300lm; 4000K) incl. • DC 3,7V 1200mAh incl. IP44 • 3-5m, 120° black/white



5 996595 770051

77024 P

LED / 1,2W (8lm, 20lm; 3000K) incl. DC 1,2V 600mAh incl. • IP44 black



5 996595 770242

77203 P

LED / 0,06W (3lm, 5lm; 3000K) incl. • DC 1,2V 300mAh incl. 8h • IP44 black/transparent



5 996595 772031

77004 P

LED / 0,5W (13lm, 20lm; 4000K) incl. DC 1,2V 600mAh incl. • IP44 black/white



5 996595 770044

SEPIK



7701B

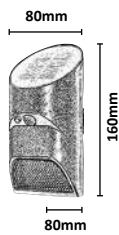

KAPUAS



77015

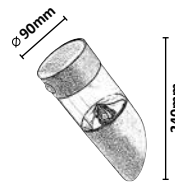

BREZNO



77006

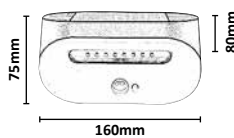

LUTTO

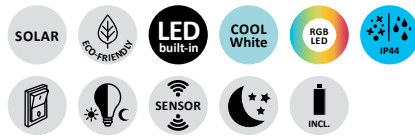

77030

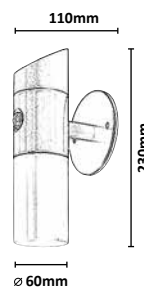

77030



7701B



LED / 3,6W (150lm, 260lm; 4000K) incl.
DC 3,7V 1800mAh incl.
IP44 • 3-5m, 120°
black/white



5 996595 770136

77015



LED / 1,5W (100lm, 130lm; 4000K) incl.
DC 3,7V 600mAh incl.
IP44 • 5-8m, 120°
black/transparent



5 996595 770150

77006



LED / 3,2W (145lm, 200lm;
4000K) incl. • DC 3,7V 1200mAh incl.
IP44 • 3-5m, 120°
black/white



5 996595 770068

77030



LED / 1W (65lm, 90lm;
6500K) incl. • IP44 • 10m, 90°
DC 3,7V 1200mAh
black/white



5 996595 770303

77205



MONTORO

- SOLAR
- ECO-FRIENDLY
- LED built-in
- WARM White
- IP44
- Lightbulb icon
- 2 PCS / SET
- INCL.
- Product icon
- New



77205

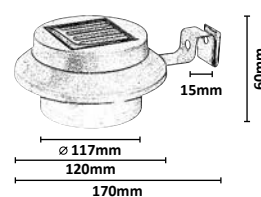

ISPRA

- SOLAR
- ECO-FRIENDLY
- LED built-in
- WARM White
- IP44
- Lightbulb icon
- 4 PCS / SET
- INCL.
- Product icon
- New



77166

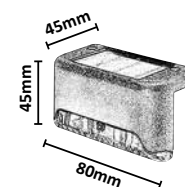

77166



77205 (P)

LED / 0,06W
 (2)3lm, (3)5lm; 3000K incl.
 DC 1,2V 300mAh incl. • IP44
 8h • white



77166 (P)

LED / 0,06W
 (2)2lm, (3)3lm; 3000K incl.
 DC 1,2V 300mAh incl. • IP44
 8h • black/transparent



OSTRAVA



7880



7881

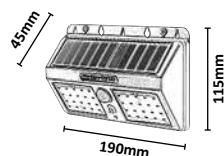

OPAVA



7970

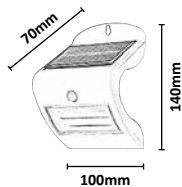

7880



☑ LED / 1,3W
 (☑100lm, ☑103lm; 4000K) incl.
 DC 3,7V incl. • IP44
 ☑ 0-3m, 120° • black



5 998250 378800

7881



☑ LED / 2,4W
 (☑225lm, ☑250lm; 4000K) incl.
 DC 3,7V incl. • IP44
 ☑ 0-3m, 120° • black



5 998250 378817

7970



☑ LED / 2W
 (☑115lm, ☑120lm; 4000K) incl.
 DC 3,7V incl. • IP44
 ☑ 2-8m, 90° • white



5 998250 379708

77159, 77160



TARCAL



77159 PG

LED / 6W (1000lm, 1300lm; 3000K, 4000K, 6500K) incl. • IP65
3m, 120° • DC 3,7V 2200mAh
black/white



77160 PG

LED / 8W (1200lm, 1500lm; 3000K, 4000K, 6500K) incl. • IP65
3m, 120° • DC 3,7V 2600mAh
black/white



FLAXTON



77040

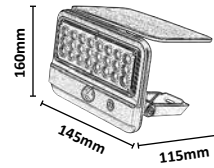

77090

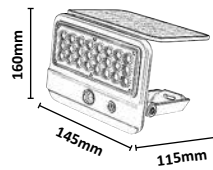

77040, 77090

Mode A

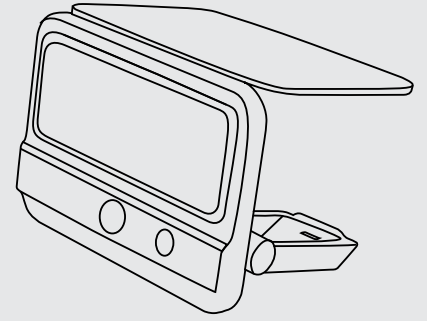

Mode B

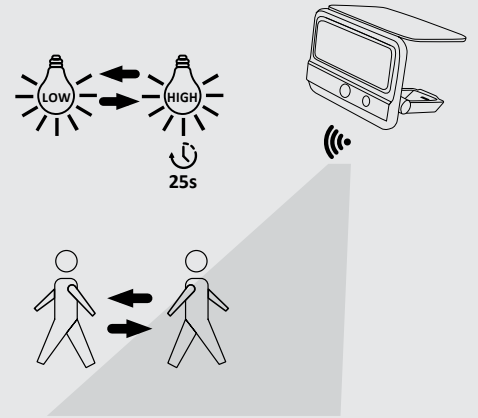

Mode C

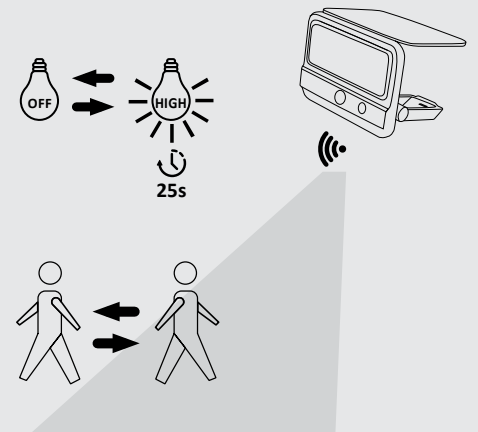

77040



LED / 7W (700lm, 800lm; 4000K) incl. • IP54
3-5m, 120° • DC 3,7V 3000mAh
black/transparent



5 996595 770402

77090



LED / 7W (700lm, 800lm; 4000K) incl. • IP54
3-5m, 120° • DC 3,7V 3000mAh
white/transparent



5 996595 770907



LIHULL

SOLAR

ECO-FRIENDLY

LED
built-in

NATURAL
White

IP44

SENSOR

INCL.



77020

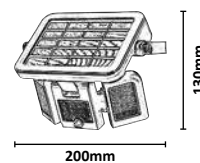

77020 **P**

LED / 9,6W (500lm, 600lm;
4000K) incl. • IP44 • 5-8m, 120°
DC 3,7V 3000mAh incl.
black/transparent



MELK



7714I

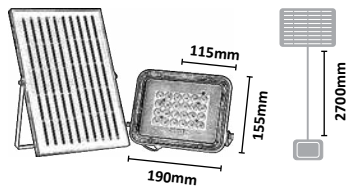

ZAVOD



77129

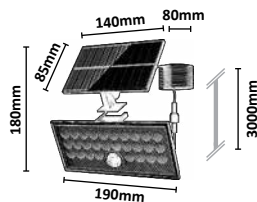

VALPOVO



77019

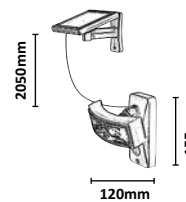

ZLARIN



77012

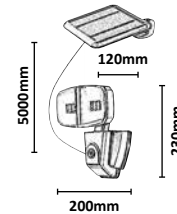

7714I



7714I

P

LED / 6,5W (1000lm, 1050lm; 3000K, 4000K, 6500K) incl. • IP65
568 • DC 3,2V 1000mAh (3,7V DC) incl.
black/transparent



5 996595 771416

77019

P

LED / 2,4W (250lm, 300lm; 4000K) incl.
DC 3,7V 1200mAh incl.
IP44 • 5-8m, 120°
black/transparent



5 996595 770198

77129

P

LED / 8W (880lm, 880lm; 5000K) incl. • IP65 • 8m, 120°
579 • DC 3,7V 1800mAh
black/transparent



5 996595 771294

77012

P

LED / 12W (700lm, 800lm; 4000K) incl.
DC 3,7V 4000mAh incl.
IP44 • 5-8m, 120°
black/white



5 996595 770129

— SAVOCA —



77167

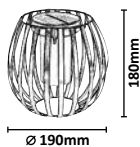

— YOLA —



7850



— TAPOLCA —



77176



— SLUIS —



77046

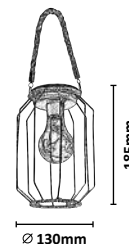

77167 (M) (P)

LED / 1W
 (5lm, 8lm; 3000K) incl.
 IP44 • DC 1,2V 300mAh
 black/white



5 996595 771676

7850 (M) (G)

RGB LED / 0,06W
 (11lm, 6lm; 3000K) incl.
 DC 1,2V 60mAh incl.
 IP44 • • satin chrome/transparent



5 998250 378503

77176 (M)

LED / 0,16W
 (2lm, 5lm; 3000K) incl.
 IP44 • DC 1,2V 400mAh
 white



5 996595 771768

77046 (M) (P)

LED / 0,2W
 (3lm, 5lm; 3000K) incl.
 IP44 • DC 1,2V 600mAh
 black/transparent



5 996595 770464

TRILLO



77175



HOLNE



77188

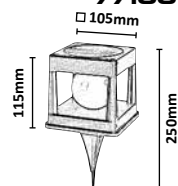

BOKOD



77187

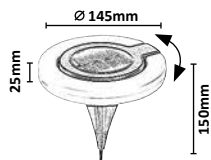

DANNET



7975

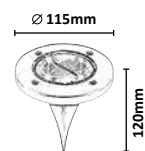

77187



77175

(P)

LED / 0,3W
 (15lm, 17lm; 4000K) incl.
 DC 1,2V 800mAh incl. • IP65
 transparent



5 996595 771751

77188

(P)

LED / 0,3W
 (6lm, 16lm; 2500K-3000K) incl.
 DC 3,7V 800mAh incl. • IP44
 black/white



5 996595 771881

77187

(P)

LED / 0,05W
 (5lm, 7lm; 2500K-3000K) incl.
 DC 1,2V 300mAh incl. • IP44
 black/white



5 996595 771874

7975

(M)(P)

LED / 0,24W
 (20lm, 25lm; 3000K)
 DC 1,2V 400mAh incl. • IP44
 satin chrome/ black



5 998250 379753



MORA



8948

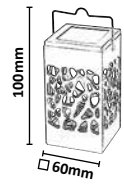

8949

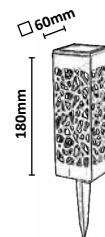

8948

P

☑ LED / 0,07W
 (☑11lm, ☑3lm; 3000K) incl.
 DC 1,2V 200mAh incl. • ☑
 IP23 • black



8949

P

☑ LED / 0,16W
 (☑21lm, ☑41lm; 3000K) incl.
 DC 1,2V 400mAh incl. • ☑
 IP23 • black



KROBIA



7814

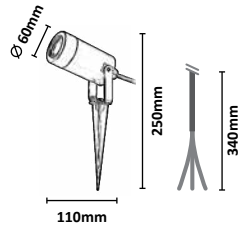

NANTES



77088

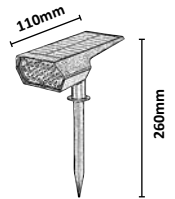

TURDA



7060

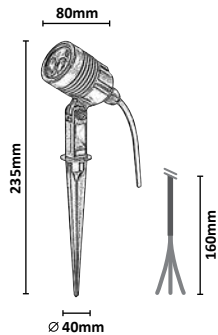

KELNA



77011

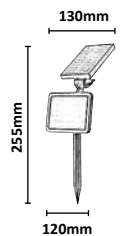

7814



☒ GU10 / 1x max. 4W
IP65
black/transparent



5 998250 378145

7060



☒ LED / 3W
(☒260lm, ☒360lm;
4000K) incl. • IP65
black/transparent



5 998250 370606

77088



☒ LED / 0,5W
(☒50lm, ☒250lm; 3000K) incl.
IP65 • DC 3,7V 1500mAh
black/transparent



5 996595 770884

77011



☒ LED / 9,6W
(☒200lm, ☒240lm; 4000K) incl.
DC 3,7V 2000mAh incl. • IP44
black/white



5 996595 770112



CONG



77186

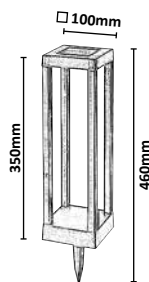

FUNGHETTO



7877

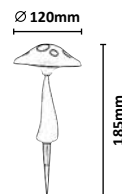

RAVELLO



77158

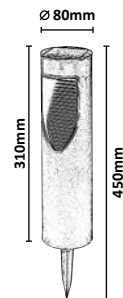

77186



LED / 0,18W
 (61mm, 71mm; 4000K) incl.
 DC 3,7V 500mAh incl. • IP44
 black



5 996595 771867

7877



LED / 0,06W
 (3000K) incl.
 DC 1,2V 300mAh incl. •
 IP44 • red/white



5 998250 378770

77158



LED / 0,1W
 (51mm, 101mm; 3000K) incl.
 DC 1,2V 600mAh incl. • IP44
 black



5 996595 771584

MONOR



77177

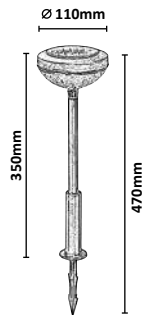

SOLAR 1



8365

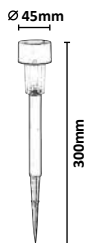

8366

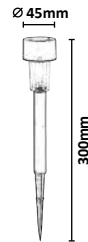

77177



77177

P

LED / 0,1W
(11lm, 15lm; 3000K) incl.
DC 1,2V 600mAh incl. • IP44
black/transparent



5 996595 771775

8365

P

LED / 0,1W incl.
(11lm, 15lm)
DC 1,2V 40mAh incl.
IP44 • black



5 998250 383651

8366

M P

LED / 0,1W incl.
(11lm, 15lm)
DC 1,2V 40mAh incl.
IP44 • satin chrome/stainless steel



5 998250 383668

TAVIRA

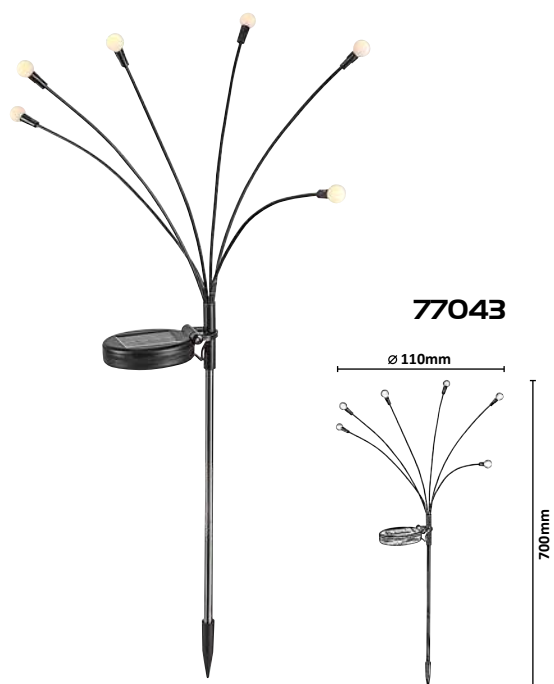

ZIRC



77043



LED / 0,06W
 (3lm, 5lm; 3000K) incl.
 DC 1,2V 300mAh incl. • IP44
 8h • black/white



5 996595 770433

77165



LED / 3,6W
 (35lm, 40lm; 2700K) incl.
 IP44 • DC 3,7V 1200mAh
 black/transparent



5 996595 771652



WIGRY



77001

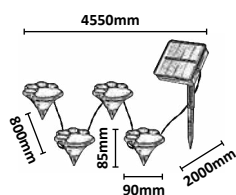

BOBUS

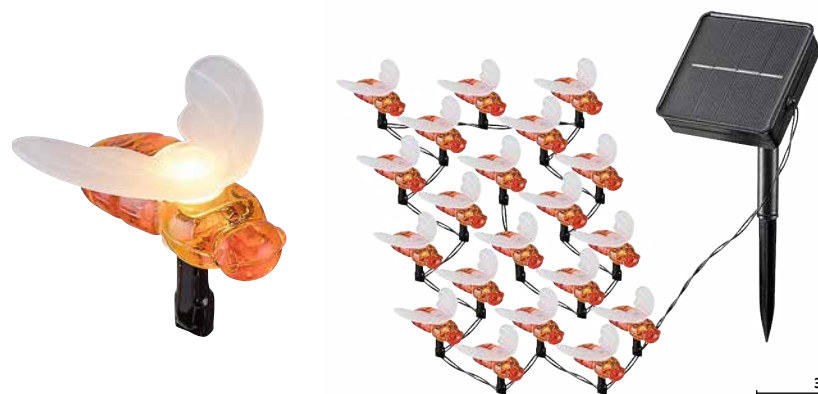

77002

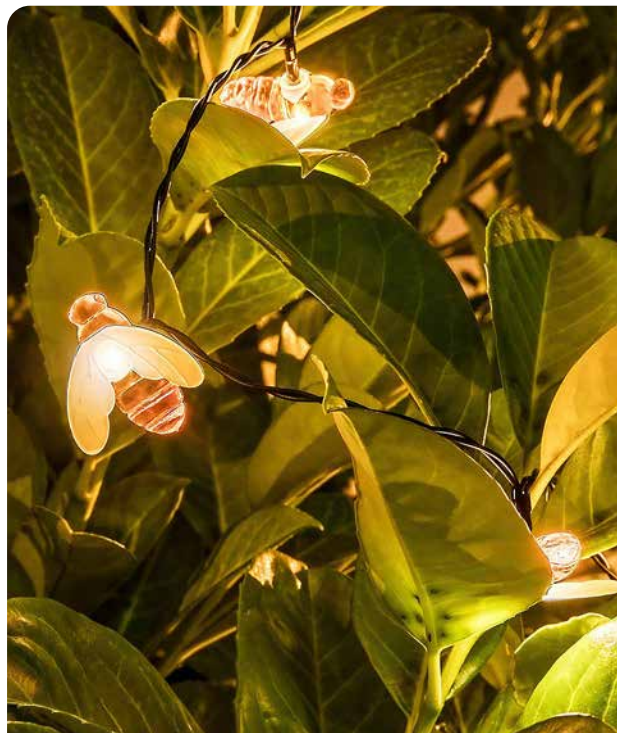
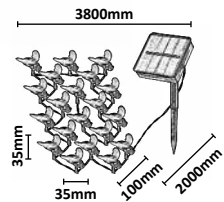

77001

P

LED / 0,06W
 (33lm, 38lm; 3000K) incl.
 DC 1,2V 600mAh incl. • IP44
 black/white



5 996595 770013

77002

P

LED / 0,06W
 (33lm, 38lm; 2700K) incl.
 DC 1,2V 600mAh incl. • IP44
 black/white



5 996595 770020

ANSOO



BIRI



77123

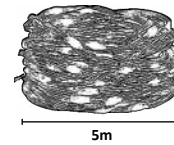

77124

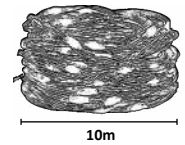

77016



LED / 0,26W
 (30lm, 35lm; 3000K) incl.
 DC 3,2V 400mAh incl. • IP44
 white



77123



RGB LED / DC 5V / 2,8W
 IP44
 554
 transparent/white



77124



RGB LED / DC 5V / 3,2W
 IP44
 554
 transparent/white



LED STRIP



79022, 79023



79021

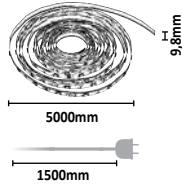

79022



79023

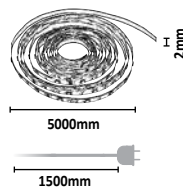

79021 P

LED / AC 230V / 21W
(2000lm; 4000K) incl.
15.000h • IP67 • 576



79022 P

RGB LED / DC 12V / 19W
CR2025 incl.
25.000h • IP44 • 577



79023 P

RGB LED / DC 12V / 19W
CR2025 incl.
25.000h • IP20 • 578





EXTRA FEATURES • EXTRA FUNKCIÓK • EXTRA FUNKTIONEN



Our SMART marked lights can be controlled via the TUYA app available on your smartphone or tablet. The app makes it simple and easy to change the colour temperature and brightness of the lamp, so you can quickly and easily adjust the light to the mood of the occasion during a garden party!



SMART jelöléssel ellátott lámpáink okostelefonon vagy táblagépen elérhető TUYA applikáción keresztül vezérelhetők. Az alkalmazással egyszerűen és könnyedén változtatható a lámpa színhőmérséklete és fényereje, így egy kerti összejövetel közben egyszerűen és gyorsan az adott hangulathoz igazítható a lámpa fénye!



Unsere SMART-gekennzeichneten Leuchten können über die TUYA-App gesteuert werden, die auf Ihrem Smartphone oder Tablet verfügbar ist. Mit der App können Sie ganz einfach die Farbtemperatur und die Helligkeit der Lampe ändern. So können Sie das Licht bei einer Gartenparty schnell und einfach an die Stimmung des Anlasses anpassen!

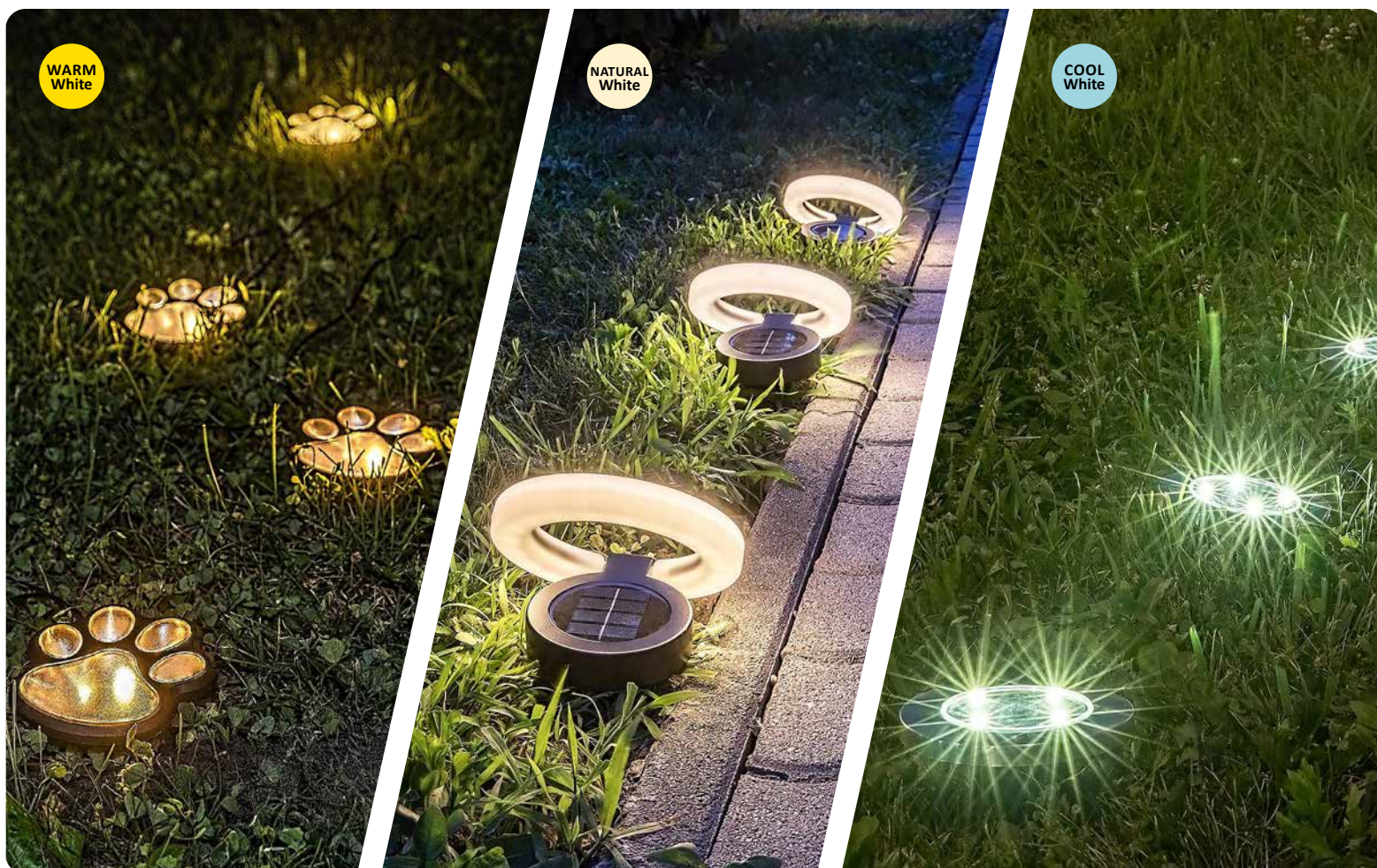



Colour Temperature: LED lamps offer three options: cool, natural, and warm white. Adjustable colour temperature lamps allow you to adapt the light to your activity or mood. Warm white is ideal for relaxation, while cool white suits tasks requiring focus. CCT lamps let you adjust the colour temperature any time after installation, while CCT SWITCH lamps require selection before installation.



Színhőmérséklet: A LED lámpák három színhőmérsékletet kínálnak: hideg, természetes és meleg fehér. Az állítható színhőmérsékletű lámpák lehetővé teszik a fény hangulathoz vagy tevékenységhez igazítását. A meleg fehér relaxációhoz, a hideg fehér pedig koncentrációt igénylő feladatokhoz ideális. CCT lámpák esetén a színhőmérséklet utólag is állítható, míg CCT SWITCH lámpáknál ezt felszerelés előtt kell beállítani.



Farbtemperatur: LED-Lampen bieten drei Farbtemperaturen: kaltweiß, neutralweiß und warmweiß. Lampen mit einstellbarer Farbtemperatur ermöglichen die Anpassung des Lichts an Stimmung oder Aktivität. Warmweiß eignet sich für Entspannung, kaltweiß für Aufgaben, die Konzentration erfordern. Bei CCT-Lampen kann die Farbtemperatur nach der Installation angepasst werden, während sie bei CCT SWITCH-Lampen vor der Montage eingestellt werden muss.



RGB: RGB (Red-Green-Blue) lighting means that the lamp contains red, green, and blue chips, creating colourful mood lighting. This feature offers creative and unique lighting options and is perfect for creating special light shows.



RGB: Az RGB (Red-Green-Blue) világítás alatt azt értjük, hogy az adott lámpa vörös, zöld és kék chipeket tartalmaz, melyek színes hangulatvilágítást eredményeznek. Ez a funkció kreatív és egyedi megvilágítási lehetőségeket kínál, és alkalmas lehet különleges fényjátékok létrehozására.



RGB: RGB (Rot-Grün-Blau) Beleuchtung bedeutet, dass die Lampe rote, grüne und blaue Chips enthält, die eine farbenfrohe Stimmungsbeleuchtung erzeugen. Diese Funktion bietet kreative und einzigartige Beleuchtungsmöglichkeiten und eignet sich perfekt für spezielle Lichtspiele.



Dimming: Dimming refers to the ability to adjust the lamp's brightness. This can be done in a gradual or continuous manner, using various methods such as switches, touch controls, remote controls, or even apps.



Fényerő-szabályozás: A dimmelhetőség a lámpa fényerősségének változtatását jelenti. Ennek módja lehet fokozatos vagy folyamatos, valamint különböző módon történhet: kapcsolóval, érintéssel, távirányítóval, vagy akár applikációval



Dimmbarkeit: Dimmbarkeit bezeichnet die Möglichkeit, die Helligkeit der Lampe anzupassen. Dies kann stufenweise oder kontinuierlich erfolgen, und zwar auf unterschiedliche Weise: mit Schaltern, Berührung, Fernbedienung oder sogar per App.





INFORMATION BLOCK • INFORMÁCIÓS BLOKK • INFORMATIONSBLOCK

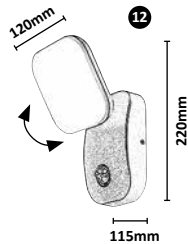

1 **9999** 2 **MT**

3 LED / 50W (3080lm, 3000K-6000K) incl.

4 E27 / 1x max. 60W

5 IP20 • 6 19500 • 7 523

8 • DC 1,2V • 9 1xAA incl.

10 white

11 
5 998250 362502

- 1
- Item No.
 - cikkszám
 - Artikelnummer
 - no. article
 - objednací číslo
 - Číslo položky
 - nr artykułu
 - номер виробу
 - nr. Articol
 - Br. Artikla
 - broj artikla
 - številka artikla / artikel št.
 - № на артикул
 - elemento Nr.
 - izstrādājuma Nr.
 - toote Nr.

- 2
- material of the product
 - a termék anyaga
 - Material des Produkts
 - matériau du produit
 - materiál výrobku
 - materiál výrobu
 - Material produktu
 - materialul produsului
 - materijal proizvoda
 - materijal proizvoda
 - material izdelka
 - material na produkta
 - produktu medžiaga
 - produkta materiāls
 - toote materjal

- 3
- technical data of lightsource for lamp
 - a lámpához adott fényforrás műszaki adatai
 - Technische Daten des Leuchtmittels zur Leuchte
 - caractéristiques techniques de l'ampoule du luminaire
 - technické údaje svetelného zdroje dodávaného s lampou
 - technické údaje zdroja svetla priloženého k lampe
 - dane techniczne źródła światła dostarczonego z lampą
 - технічні дані джерела освітлення для даної лампи
 - datele tehnice ale sursei de lumină pentru lampă
 - tehnički podaci o izvoru svetlosti za lampu
 - tehnički podaci izvora svetlosti koji je priložen uz lampu
 - tehnični podatki vira svetlobe za svetilko
 - технически данни на източника на светлина, приложен към лампата
 - šviestuvo šviesos šaltinio techniniai duomenys
 - lampas gaismas avota tehniskie dati
 - lampi valgusallika tehnilised andmed

- 4
- the specifications of the lightsource
 - a fényforrásra vonatkozó műszaki adatok
 - Angaben zur Lichtquelle
 - les spécifications de la source lumineuse
 - specifikace světelného zdroje
 - specifikácie svetelného zdroja
 - Specyfikacja źródła światła
 - технічні характеристики джерела освітлення
 - specificații sursă de iluminat
 - specifikacije svetlosnog izvora
 - specifikacija izvora svjetlosti
 - specifikacije svetlobnega vira
 - характеристики на светлинния източник
 - šviesos šaltinio specifikacijos
 - gaismas avota specifikācijas
 - valgusallika tehnilised andmed

- 5
- IP protection
 - IP védettség
 - IP-Klasse
 - protection IP
 - IP krytí
 - IP ochrana
 - Stopień ochrony IP
 - Клас IP-захисту
 - Protectia IP
 - IP zaštita
 - IP zaštita
 - IP zaštita
 - c IP защита
 - IP klasē
 - IP aizsardzība
 - IP kaitse

- 6
- article number of the replacement lampshade
 - pótbúra cikkszám
 - Artikelnummer des Ersatz-Lampenschirms
 - numéro d'article de l'abat-jour de remplacement
 - číslo výrobku náhradního stínítka
 - číslo výrobku náhradného tienidla
 - Numer artykułu wymiennego klosza
 - номер виробу запасного абажура
 - număr de articol pentru abajurul înlocuitor
 - Br. artikla rezervnog abažura
 - broj artikla zamjenskog sjenila
 - številka izdelka nadomestnega senčila
 - № на артикул на допълнителен абажур
 - pakaitinio lempos gaubto prekės numeris
 - rezerves abažūra precēs numurs
 - asenduslambivarju artiklinumber

- 7
- item number remote controller
 - a távirányító cikkszám
 - Artikelnummer der Fernbedienung
 - numéro d'article de la télécommande
 - Číslo položky dálkového ovladače
 - Číslo položky diaľkového ovládača
 - Numer produktu pilota
 - Номер елемента дистанційного керування
 - Număr articol pe telecomandă
 - Broj stavke daljinskog upravljača
 - Broj stavke daljinskog upravljača
 - Številka izdelka daljinskega upravljalnika
 - Kataložen numer na distančionnoho upravlenie
 - Nuotolinio valdymo pulto prekės numeris
 - Tālvadības pults vienuma numurs
 - Puldi artiklinumber

- 8
- type of switch
 - a kapcsoló típusa
 - Typ des Schalters
 - type d'interrupteur
 - druh vypínače
 - druh vypínača
 - Typ przelazcznika
 - тип перемикача
 - tip de comutator
 - tip prekidača
 - vrsta prekidača
 - vrsta stikala
 - тип на ключа
 - jungklio tipas
 - sledža tips
 - lüliti tüüp







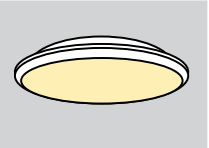
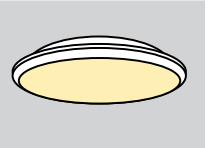

- 9
- battery specification
 - elemmel kapcsolatos információk
 - Batteriespezifikation
 - spécifications de la pile
 - specifikace baterie
 - specifikácia batérie
 - Specyfikacja baterii
 - специфікація акумулятора
 - specificații baterie
 - specifikacija baterije
 - specifikacija baterije
 - specifikacija baterij
 - характеристики на батерията
 - baterijos specifikacijos
 - baterijas specifikācija
 - patareih tehnilised andmed

- 10
- colour of the product
 - a termék színe
 - Farbe des Produkts
 - couleur du produit
 - boja produktu
 - farba produktu
 - Kolor produktu
 - колір виробу
 - culoarea produsului
 - boja proizvoda
 - boja proizvoda
 - barva izdelka
 - цвет на продукта
 - produktu spalva
 - produkta krāsa
 - toote värv

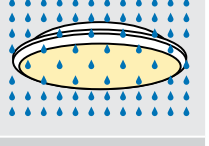
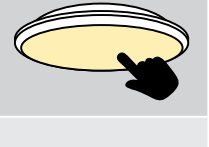
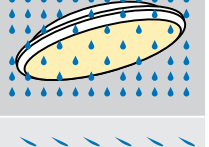
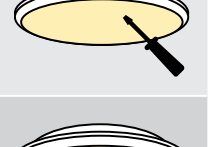
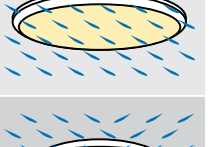
- 11
- EAN code
 - EAN- kód
 - EAN-Code
 - code EAN
 - EAN- kód
 - EAN- kód
 - cod EAN
 - cod EAN
 - EAN kód
 - EAN- kod
 - EAN koda
 - EAN kod
 - EAN kodas
 - EAN kods
 - EAN-kood

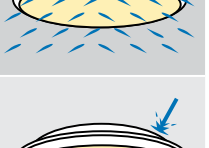
- 12
- sizes
 - méretek
 - Maß
 - dimensions
 - rozměry
 - rozmiery
 - wymiary
 - rozmiiri
 - mārimi
 - dimenzije
 - dimenzije
 - mere
 - razмери
 - izmatavimai
 - izmēri
 - suurused

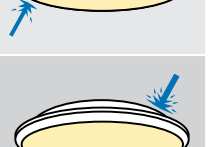
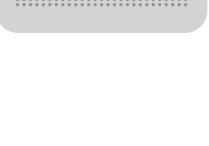
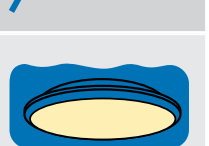
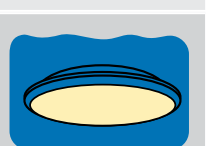
IP RATING • IP VÉDELEM • IP-SCHUTZ

Level of protection • Védelem szintje • Schutzgrad		Level of protection • Védelem szintje • Schutzgrad	
SOLIDS • SZILÁRD TÁRGYAK • FREMDKÖRPER		WATER • VÍZ • WASSER	
	0 EN: No protection. HU: Nincs védelem. DE: Nicht geschützt.		0 EN: No protection. HU: Nincs védelem. DE: Nicht geschützt.
	1 EN: Protected against a solid object greater than 50mm, e.g. a hand. HU: 50 mm vagy nagyobb átmérőjű szilárd tárgyak (pl. kézfej) ellen védett. DE: Geschützt gegen feste Fremdkörper größer als 50 mm (z. B. Handrücken)		1 EN: Protected against vertical water drops. HU: Függőleges irányból leeső vízcseppek ellen védett. DE: Geschützt gegen senkrecht fallendes Tropfwasser
	2 EN: Protected against a solid object greater than 12.5mm, e.g. a finger. HU: 12,5 mm vagy annál nagyobb átmérőjű szilárd tárgyak (pl. ujj) ellen védett. DE: Geschützt gegen feste Fremdkörper größer als 12,5 mm (z. B. Finger)		2 EN: Protected against a 15° angle from normal position. HU: Függőleges irányból leeső vízcseppek ellen védett, a lámpa 15 fokos dőlése mellett. DE: Geschützt gegen Tropfwasser bis 15° zur Senkrechten
	3 EN: Protected against a solid object greater than 2.5mm, e.g. a tool. HU: 2,5 mm vagy annál nagyobb átmérőjű szilárd tárgyak (pl. hegyes szerszám) ellen védett. DE: Geschützt gegen feste Fremdkörper größer als 2,5 mm (z. B. spitze Werkzeuge)		3 EN: Protected against water spray at a 60° angle. HU: Vízpermettől védett legfeljebb 60 fokos szög esetén. DE: Geschützt gegen Sprühwasser bis 60° zur Senkrechten
	4 EN: Protected against a solid object greater than 1.0mm, e.g. a wire. HU: 1 mm vagy annál nagyobb átmérőjű szilárd tárgyak (pl. drót) ellen védett. DE: Geschützt gegen feste Fremdkörper größer als 1 mm (z. B. Draht)		4 EN: Protected against water splashing from any angle. HU: Bármely irányból fröccsenő víz ellen védett. DE: Geschützt gegen Spritzwasser aus allen Richtungen
	5 EN: Dust protected. Prevents ingress of dust sufficient to cause damage. HU: Porvédett. Megakadályozza a károsodás okozásához elegendő mennyiségű por behatolását. DE: Staubgeschützt. Geschützt gegen schädliche Staubablagerungen		5 EN: Protected against water jets from any angle. HU: Vízugarak ellen védett minden irányból. DE: Geschützt gegen Strahlwasser aus allen Richtungen
	6 EN: Dust tight. No ingress of dust. HU: Porálló. A burkolat nem engedi át a port. DE: Staubdicht. Vollständig geschützt gegen Berührung und Eindringen von Staub		6 EN: Protected against powerful water jets and heavy seas. HU: Erős vízugar ellen védett. DE: Geschützt gegen starkes Strahlwasser
<h1>IP 65</h1>			7 EN: Water tight against the effect of temporary immersion in water of a depth between 15cm to 1m for up to 30 minutes. HU: Vízbe merítés ellen védett, ha a lámpát ideiglenesen, legfeljebb 30 perc 15 cm és 1 m közötti mélységű vízbe merítik. DE: Geschützt beim Eintauchen bis zu 30 Minuten bei einer Wassertiefe von 15 cm bis zu 1 m
			8 EN: Water tight against long periods of immersion in water (up to 4m). HU: Folyamatos vízbe merítés káros hatásaitól védett (4 m mélységig). DE: Geschützt beim Untertauchen für längere Periode (bis zu 4 m)

IK CODE • IK-KÓD • IK-CODE

Degree of protection against external mechanical impacts (W), in Joule:

Külső mechanikai igénybevételekkel szembeni védettség(W), Joule-ban • Schutz gegen äußere mechanische Kräfteinwirkungen (W), in Joule:

IK-Code	IK01	IK02	IK03	IK04	IK05	IK06	IK07	IK08	IK09	IK10
W (J)	0.14	0.2	0.35	0.5	0.7	1	2	5	10	20

COLOURS • SZÍNEK • FARBEN

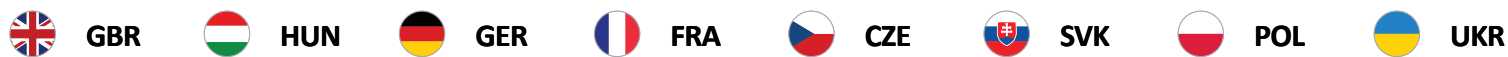

alabaster	alabástrom	Alabasterglas	verre albâtre	alabastrové sklo	alabastrové sklo	szkło alabastrowe	алебастрове скло
anthracite	antracit	Anthrazit	anthracite	antracitová	antracit	antracyt	антрацитовий
antique brown	antik barna	Antikbraun	brun antique	antická hnědá	antická hnedá	brąz antyczny	антично коричневий
antique gold	antik arany	Antikgold	or antique	antická zlatá	antická zlatá	złoto antyczne	антично золотий
antique white	antik fehér	Antik Weiß	blanc antique	antikovaná bílá	antická biela	biały antyk	античний білий
black	fekete	Schwarz	noir	černá	čierna	czarny	чорний
blue	kék	Blau	bleu	modrá	modrá	niebieski	синій
brown	barna	Braun	brun	Hnědá	hnedá	Brązowy	коричневий
chrome	króm	Chrome	chrome	chromová	chrómová	chrom	хромовий
gold	arany	Gold	or	zlato	zlato	złoto	золото
green	zöld	Grün	vert	zelená	zelená	zielony	зелений
grey	szürke	Grau	gris	šedá	šedá	popielaty	сірий
grey-beige	szürkésbézs	grau-beige	gris-beige	šedoběžová	šedoběžová	szaro-beżowy	сіро-бежевий
matte black	matt fekete	Mattschwarz	noir mat	matná černá	matná čierna	czarny matowy	матово-чорний
matte white	matt fehér	Mattweiss	blanc mat	matná bílá	matná biela	biały matowy	матово-білий
multicolour	többszínű	Multicolor	multicolore	vícebarevná	viacfarebná	wielokolorowy	багатокольоровий
opal glass	opál üveg	Opalglas	verre opal	opálové sklo	opálové sklo	szkło opalizowane	скло опал
red	piros	Rot	rouge	červená	červená	czerwony	червоний
satin chrome	szatin króm	Satin-Chromfarbig	chrome satiné	hedvábně lesklá chro- mová	saténová chrómová	chrom satyna	сатиново хромовий
silver	ezüst	Silber	argent	stříbrná	strieborná	srebrny	срібний
stainless steel	rozsdamentes acél	Edelstahl	acier inoxydable	nerezová ocel	nehrdzavejúca oceľ	stal nierdzewna	нержавіюча сталь
tinted colour	füst színű	Rauchfarbig	fumée	dýmová barva	dymová	przydymiony	димчастий
transparent	átlátszó	transparent	transparent	průhledná	priehľadná	przezroczysty	прозорий
white	fehér	Weiss	blanc	bílá	biela	biały	білий
wood imitation	fa utánczat	Holzimitat	imitation bois	imitace dřeva	imitácia dreva	imitacja drewna	імітація дерева

COLOURS • SZÍNEK • FARBEN



sticlă alabastru	alabastar staklo	alabastar staklo	alabastrno steklo	алабастрово стъкло	rīsu akmens stikls	rīsu akmens stikls	riisikivi klaas
antracit	antracit	antracit	antracitna	антрацитен	antracito pilka	antracīta pelēks	hall antratsiit
maro antic	staro smeđa	staro smeđe	starano rjav	антично кафяв	antikos ruda	antīki brūns	antiik-pruun
auriu antic	staro zlato	staro zlato	staro zlato	антично златен	antikos auksinē	antīks zelts	antiik-kuld
alb antichizat	antik bela	antik bijela	antik bela	антично бяло	antikos balta	antīki balts	antiik-valge
negru	crno	crno	črno	черен	juoda	melns	must
albastru	plavo	plavo	modro	син	mēlyna	zils	sinine
maro	smeđa	braun	rjavo	кафяв	ruda	brūns	pruun
crom	hrom	krom	krom	хром	chrominē	hroms	kroom
aur	zlato	zlato	zlato	злато	auksas	zelts	kuld
verde	zeleno	zeleno	zeleno	зелен	žalia	zaļš	roheline
gri	sivo	sivo	sivo	сив	pilka	pelēks	hall
gri-bej	sivo-bež	sivo-bež	sivo-bež	сиво-бежово	pilka smēlinē	pelēk-bēšs	hallikas-beež
mat negru	mat crno	mat crno	mat črno	мат-черен	matinē juoda	matēti melns	matt must
mat alb	mat belo	mat bijelo	medlobel	мат-бял	matinē balta	matēti balts	matt valge
multicolor	višebojno	višebojno	večbarvno	многоцветен	įvairiaspalvė	daudzkrāsains	mitmevärviline
sticlă opal	opal staklo	opal staklo	opalno steklo	опалово стъкло	opalinio stiklo	opāla stikls	opaaklaas
roșu	crveno	crveno	rdeče	червен	raudona	sarkans	punane
crom satin	satēnasti hrom	satēnasti krom	satēnast krom	сатенен-хром	atlaso chrominē	satīna hroms	satiin-kroom
argintiu	srebrno	srebrno	srebrno	сребърен	sidabrinē	sudraba	hõbe
oțel inoxidabil	nerđajući čelik	nehrđajući čelik	nerjaveče jeklo	неръждаема стомана	nerūdijantis plienas	nerūsējošais tērauds	roostevaba teras
fumuriu	boje dima	indigo plava	barva dima	прозиращо кафяво	su atspalviu	tonēta krāsa	toonitud värv
transparent	providan	proziran	prozorno	прозрачен	skaidri	caurspīdīgs	läbipaistev
alb	belo	bijelo	belo	бял	balta	balts	valge
imitație de lemn	imitacija drveta	imitacija drva	imitacija lesa	ИМИТАЦИЯ НА ДЪРВО	medžio imitacija	koka imitācija	puidu imitatsioon

KEY OF SYMBOLS • JELMAGYARÁZAT • ZEICHENERKLÄRUNG



GBR



HUN



GER



FRA



CZE



SVK



POL



UKR

	Key of symbols	Jelmagyarázat	Zeichenerklärung	Légende	Legenda	Legenda	Objasnenie znakov	позначення умовних
	item number of spare lampshade	pótbúra cikkszám	Artikelnummer Zusatzschirm	no. d'article du globe supplémentaire	položkové číslo náhradního krytu	číslo položky náhradného tienidla	numer indeksu klosza zapasowego	артикульний номер запасного абажура
	external replacement lampshade item number	külső pótbúra cikkszám	Artikelnummer äußerer Zusatzschirm	numéro d'article globe supplémentaire extérieur	položkové číslo vnějšího náhradního krytu	číslo položky vonkajšieho náhradného tienidla	numer indeksu zewnętrznego klosza zapasowego	артикульний номер зовнішнього запасного абажура
	with light source	fényforrással együtt	mit Leuchtmittel	avec source lumineuse	se světelným zdrojem	spolu so svetelným zdrojom	z źródłem światła	разом з джерелом світла
	without light source	fényforrás nélkül	ohne Leuchtmittel	sans source lumineuse	bez světelného zdroje	bez svetelného zdroja	bez źródła światła	без джерела світла
	with switch	kapcsolóval	mit Schalter	avec commutateur	se spínačem	so spínačom	z wyłącznikiem	із перемикачем
	mounting depth	beépítési mélység	Einbautiefe	profondeur de montage	montážní hloubka	montážna hĺbka	głębokość montażowa	глибина кріплення
	motion sensor	mozgásérzékelő	Bewegungssensor	détecteur mouvement	senzor pohybu	senzor pohybu	czujnik ruchu	датчик руху
	remote controller item number	távírányító cikkszám	Artikelnummer der Fernbedienung	numéro d'article de la télécommande	Číslo položky dálkového ovladače	Číslo položky diaľkového ovládača	Numer produktu pilota	Номер елемента дистанційного керування
	Lumen with shade	Lumen adat burával	Lumen mit Schatten	Lumen avec abat-jour	Lumen se stíněním	Lumen s odtieňom	Lumen z cieniem	Люмен з плафоном
	Lumen without shade	Lumen adat búra nélkül	Lumen ohne Schatten	Lumen sans abat-jour	Lumen bez stínu	Lumen bez tieňa	Światło bez cienia	Люмен без тіні

	Lamp made of	Lámpa anyaga	Lampenmaterial	Le matériel de la lampe	Materiál lampy	Materiál svetidla	Materiał oprawy	Матеріал світильника
	acrylic	akril	acryl	acrylique	akryl	akryl	akryl	акрил
	glass	üveg	glas	verre	sklo	sklo	szkło	скло
	metal	fém	metall	métal	kov	kov	metal	метал
	plastic	műanyag	kunststoff	plastique	plast	umelá hmota	tworzywo sztuczne	пластмаса

	Further key	Egyéb magyarázat	Weitere Erklärungen	Autres explications	jiné vysvětlení	druga razlaga	inne wytłumaczenie	інше пояснення
excl.	excluded	nem tartalmaz	exklusive	excepté	neobsahuje	neobsahuje	nie zawiera	не містить
incl.	included	tartalmaz	inklusive	inclus	obsah	obsahuje	zawiera	містить



ROM



SRB



CRO



SLO



BUL



LTU



LVA



EST

	Legendă	Objasnenje znakov	Tumač znakova	Legenda	Обяснение на условни знаци	Aprašas	Apzīmējumi	Tingmärk
	număr articol abajur suplimentar	oznaka dodatnog abažura	oznaka dodatnog sjenila	koda dodatnega abažura	резервен абажур артикул №	atsarginio gaubto prekės Nr.	maiņas abažūra izstrādājuma Nr.	asenduslambikuppel nr
	număr articol abajur suplimentar pentru exterior	oznaka dodatnog spoljnog abažura	oznaka dodatnog vanjskog sjenila	oznaka dodatnega zunanjega abažura	вншен резервен абажур артикул №	išorinio atsarginio gaubto prekės Nr.	ārējā maiņas abažūra izstrādājuma Nr.	vāline asenduslambikuppel nr
	cu sursă de lumină	zajedno sa izvorom svetlosti	zajedno s izvorom svjetlosti	skupaj z virom svetlobe	включително СВЕТЛИНЕН ИЗТОЧНИК	kartu su šviesos šaltiniu	kopā ar gaismas avotu	koos valgusalikaga
	fără sursă de lumină	bez izvora svetlosti	bez izvora svjetlosti	brez svetlobnega vira	без СВЕТЛИНЕН ИЗТОЧНИК	be šviesos šaltinio	bez gaismas avota	valgusalikata
	cu întrerupător	sa prekidačem	s prekidačem	s stikalom	с превключатель	su jungikliu	ar slēdzi	lūlitiga
	adâncimea de montare	dubina ugradnje	instalacijske ugradnje	globina montaže	дълбочина на монтаж	įmontavimo gylis	iebūvēts dziļums	sisseehitatus sügavus
	senzor de mișcare	senzor kretanja	senzor kretanja	senzor gibanja	със сензор за движение	judesio jutiklis	kustības sensors	liikumisandur
	Număr articol pe telecomandă	Broj stavke daljinskog upravljača	Broj stavke daljinskog upravljača	Številka izdelka daljinskega upravljalnika	Каталожен номер на дистанционното управление	Nuotolinio valdymo pulto prekės numeris	Tālvadības pults vienuma numurs	Puldi artiklinumber
	Lumen cu umbră	Lumen sa senkom	Lumen sa sjenom	Lumen s senco	Люмен със сянка	Lumenas su šešėliu	Lūmenis ar ēnu	Varjuga luumen
	Lumen fără umbră	Lumen bez senke	Lumen bez sjene	Lumen brez sence	Люмен без сянка	Lumenas be šešėlio	Lūmenis bez ēnas	Valendik ilma varjuta

	Materialul lămpi	Materijal svetiljke	Materijal rasvetnog tijela	Material izdelka	Лампата е произведена от	Šviestuvo medžiaga	Lampas materiāls	Lambi materjal
	acril	akril	akril	akril	акрил	akrilas	akrils	akrüül
	sticlă	staklo	staklo	steklo	стъкло	stiklas	stikls	klaas
	metal	metal	metal	kovinski	метал	metalinė	metāla	metalli
	plastic	plastična	plastika	umetna masa	пластмаса	plastikas	plastmasa	plast

	alte explicații	Druga objašnjenja	Druga objašnjenja	iné vysvetlenie	други обяснения	Kiti simboliai	Citi simboli	Muud sümbolid
excl.	nu conține/ne este inclus	ne sadržava	Ne sadrži	brez (ne vsebuje)	не е включено	neturi	nesatur	ei sisalda
incl.	conține/include	sadržava	sadržava	vsebujejo	включено е	yra su	satur	sisaldab

KEY OF SYMBOLS • JELMAGYARÁZAT • ZEICHENERKLÄRUNG



	Symbols	Jelölések	Bezeichnungen	Symboles	Jména
	New	Új	Neu	Nouveau	Nový
	Designed by Rabalux	Rábalux saját tervezés	Entworfen von Rabalux	Conçu par Rabalux	Rabalux vlastní design
	Lightsource recommendation	Fényforrás ajánló	Lichtquellenempfehlung	Recommandation de source lumineuse	Doporučený světelný zdroj
	5 years guarantee	5 év garancia	5 Jahre Garantie	5 ans de garantie	Záruka 5 let
	Built-in LED	Beépített LED	LED inklusive	LED inclus	Obsahuje LED
	LED included	LED-et tartalmaz	LED inklusive	LED inclus	Obsahuje LED
	Smart product	Okos termék	Intelligentes Produkt	Produit intelligent	Chytrý produkt
	Wi-Fi	Wi-Fi	Wi-Fi	Wi-Fi	Wi-Fi
	Warm white light	Meleg fehér fényű	Warmweiß	Blanc chaud	Teplá bílá
	Natural white light	Természetes fehér fényű	Naturweiß	Blanc naturel	Přirozená bílá
	Daylight	Napfény	Tageslicht	Lumière du jour	Denní světlo
	Cool white light	Hideg fehér fényű	Kaltweiß	Blanc froid	Studená bílá
	Colour temperature variable with remote control	Távírányítóval állítható színhőmérséklet	Mit fernbedienung einstellbare Farbtemperatur	Température de couleur réglable par télécommande	Nastavení teploty chromatičnosti dálkovým ovladačem
	Adjustable colour temperature	Állítható színhőmérséklet	Einstellbare Farbtemperatur	Température de couleur réglable	Nastavitelná teplota barev
	Color temperature can be adjusted in 3 steps with a switch	Kapcsolóval 3 lépésben szabályozható színhőmérséklet	Die Farbtemperatur kann mit einem Schalter in 3 Stufen eingestellt werden	La température de couleur peut être ajustée en 3 étapes avec un interrupteur	Teplotu barev lze nastavit pomocí přepínače ve 3 krocích
	Color temperature can be adjusted in 3 steps with remote control	Távírányítóval 3 lépésben szabályozható színhőmérséklet	Die Farbtemperatur kann mit einer Fernbedienung in 3 Stufen eingestellt werden	La température de couleur peut être ajustée en 3 étapes avec une télécommande	Barevnou teplotu lze ovládat ve 3 krocích pomocí dálkového ovladače
	Color temperature can be adjusted in three steps with a touch switch	Érintőkapcsolóval három lépésben szabályozható színhőmérséklet	Die Farbtemperatur kann in drei Stufen mit einem Touch-Schalter eingestellt werden	La température de couleur peut être ajustée en trois étapes avec un interrupteur tactile	Teplotu barev lze upravit ve třech krocích dotykovým spínačem
	Color temperature can be adjusted in 3 steps with a CCT switch	CCT kapcsolóval 3 lépésben szabályozható színhőmérséklet	Die Farbtemperatur kann mit einem CCT Schalter in 3 Stufen eingestellt werden	La température de couleur peut être ajustée en 3 étapes avec un interrupteur CCT	Teplotu barev lze nastavit pomocí CCT přepínače ve 3 krocích
	RGB colour change LED	RGB színváltós LED	Farbwechsel-LED	LED à changement de couleurs	LED diody střídající barvu
	Adjustable brightness in 3 steps with switch	Kapcsolóval 3 lépésben szabályozható fényerő	Einstellbare Helligkeit mit Schalter in 3 Stufen	Luminosité ajustable avec interrupteur à 3 positions	Nastavitelný jas pomocí spínače ve 3 krocích

KEY OF SYMBOLS • JELMAGYARÁZAT • ZEICHENERKLÄRUNG



	Označenia	Oznaczenia	Позначення	Simboluri	Označavanje
	Nový	Nowy	Новий	Nou	Novo
	Rabalux vlastný dizajn	Zaprojektowano przez Rabalux	Розроблений Rabalux	Designed de Rabalux	Rabalux dizajn
	Odporúčanie svetelného zdroja	Rekomendowane źródło światła	Рекомендація щодо джерела світла	Recomandare sursa de lumina	Preporuka za tip sijalice
	Záruka 5 rokov	5-letnia gwarancja	Гарантія 5 років	5 ani garanție	5 godina garancije
	Obsahuje LED diódy	Dioda LED w wyposażeniu	Містить світлодіоди	LED încorporat	Ugrađeni LED
	obsahuje LED diódy	Dioda LED w wyposażeniu	Містить світлодіоди	LED inclus	Sa LED diodom
	Inteligentný produkt	Inteligentny produkt	Розумний продукт	Produs inteligent	Pametnan proizvod
	Wi-Fi	Wi-Fi	Wi-Fi	Wi-Fi	Wi-Fi
	Teplá biela	Ciepła biała	Теплий білий	Alb cald	Toplo bela
	Prírodná biela	Naturalna biała	Натуральний білий	Alb natural	Prirodno bela
	Denné svetlo	Światło dzienne	Денне світло	Lumină naturală	Dnevna svetlost
	Studená biela	Zimna biała	Холодний білий	Alb rece	Hladno bela
	Možnosť nastavenia teploty farieb s diaľkovým ovládačom	Zmienna temperatura barwowa za pomocą pilota	Регулювання колірної температури через пульт дистанційного керування	Temperatura culorii reglabilă de la telecomandă	Sa daljinskim prekidačem može da se podesi temperatura boja
	Nastaviteľná teplota farieb	Można regulować temperaturę barwową	Регульована колірна температура	Temperatura de culoare reglabilă	Podesiva temperatura boje
	Farbnú teplotu je možné nastaviť v 3 krokoch pomocou prepínača	Temperaturę barwową można regulować w 3 krokach za pomocą przełącznika	Колірну температуру можна регулювати в 3 кроки за допомогою перемикача	Temperatura de culoare poate fi reglată în 3 trepte cu un comutator	Temperatura boje se može podesiti u 3 koraka pomoću prekidača
	Farbnú teplotu je možné nastaviť v 3 krokoch pomocou diaľkového ovládača	Temperaturę barwową można regulować w 3 krokach za pomocą pilota	Колірну температуру можна регулювати в 3 кроки за допомогою пульта дистанційного керування	Temperatura de culoare poate fi reglată în 3 trepte cu ajutorul telecomenzii	Temperatura boje se može podesiti u 3 koraka pomoću daljinskog upravljača
	Teplotu farby je možné nastaviť v troch krokoch pomocou dotykového spínača	Temperaturę barwową można regulować w 3 krokach za pomocą przełącznika dotykowego	Колірну температуру можна регулювати в три етапи за допомогою сенсорного перемикача	Temperatura culorii poate fi ajustată în trei pași cu un comutator tactil	Temperatura boje se može podesiti u tri koraka pomoću prekidača na dodir
	Farbnú teplotu je možné nastaviť v 3 krokoch pomocou prepínača CCT	Temperaturę barwową można regulować w 3 krokach za pomocą przełącznika CCT	Колірну температуру можна регулювати в 3 кроки за допомогою CCT-перемикача	Temperatura de culoare poate fi reglată în 3 trepte cu un comutator CCT	Temperatura boje se može podesiti u 3 koraka pomoću CCT prekidača
	LED s meniacou sa farbou	Zmieniający kolor LED	Світлодіоди зі зміною кольору	LED RGB	LED sa promenjivim bojama
	Nastaviteľný jas pomocou spínača v 3 krokoch	Jasność dostosowywana przełącznikiem w 3 krokach	Регульована яскравість з перемикачем в 3 кроки	Luminozitate ajustabilă prin comutator în 3 trepte	Podesivo osvetljenje u 3 koraka uz pomoć prekidača

KEY OF SYMBOLS • JELMAGYARÁZAT • ZEICHENERKLÄRUNG



CRO



SLO



BUL



LTU



LVA



EST

	Oznake	Oznake	Символи	Simboliai	Simboli	Sümbolid
	Novo	Novo	Ново	Naujas	Jauns	Uus
	Dizajnirao Rablux	Zasnoval Rabalux	Проектирано от Rabalux	Suprojektavo „Rabalux“	Izstrādājis Rabalux	Rabaluxi disain
	Preporuka izvora svjetla	Odporúčanie svetelného zdroja	Препоръка за източник на светлина	Šviesos šaltinio rekomendacija	Ieteikums par gaismas avotu	Valgusallika soovitus
	5 godina jamstva	5 let garancije	5 години гаранция	5 metų garantija	5 gadu garantija	5-aastane garantii
	Ugrađeni LED	Vgrajen LED	Вграден LED	Įmontuotas LED įrenginys	Iebūvēta LED	Sisse-ehitatud LED
	Sadržī LED	Vsebuje LED	С включен LED	LED pridedama	LED iekļauta komplektā	LED on kaasas
	Pametan proizvod	Pameten izdelek	Интелигентен продукт	Protingas produktas	Gudrs produkts	Tark toode
	Wi-Fi	Wi-Fi	Wi-Fi	Wi-Fi	Wi-Fi	Wi-Fi
	Toplo bijelo	Toplo bela	Топло бяло	Šiltai balta	Silti balts	Soe valge
	Prirodno bijelo	Naravno bela	Естествено бяло	Natūraliai balta	Dabīgi balts	Loomulik valge
	Dnevno svjetlo	Dnevna svetloba	Дневна светлина	Dienos šviesa	Dienasgaisma	Päevavalgus
	Hladno bijelo	Hladno bela	Студено бяло	Šaltai balta	Vēsi balts	Külm valge
	Pomoću daljinskog prekidača možete podesiti temperaturu boje	Barvno temperaturo lahko nastavite z daljinskim stikalom	Регулиране на цветната температура с дистанционно управление	Kintanti spalvinė temperatūra su nuotoliniu pulteliu	Maināma krāsu temperatūra ar tālvadības pulti	Muutuv värvustemperatuur kaugjuhtimisega
	Podesiva temperatura boje	Nastavljiva barvna temperatura	Регулируема цветна температура	Reguliuojama temperatūra	Regulējama krāsu temperatūra	Reguleeritav värvustemperatuur
	Temperatura boje može se podesiti u 3 koraka pomoću prekidača	Barvno temperaturo lahko nastavite v 3 korakih s stikalom	Цветовата температура може да се регулира на 3 стъпки с превключвател	Spalvos temperatūrą galima reguliuoti 3 žingsniais jungikliu	Krāsu temperatūru var regulēt 3 soļos ar slēdzi	Värvitemperatuuri saab lülitiga reguleerida 3 astmes
	Temperatura boje može se podesiti u 3 koraka daljinskim upravljačem	Barvno temperaturo lahko nastavite v 3 korakih z daljinskim upravljalnikom	Цветовата температура може да се регулира в 3 стъпки с дистанционното управление	Spalvos temperatūrą nuotolinio valdymo pulteliu galima reguliuoti 3 žingsniais	Krāsu temperatūru var regulēt 3 soļos ar tālvadības pulti	Värvitemperatuuri saab puuteliitiga kolmes astmes reguleerida
	Temperatura boje može se podesiti u 3 koraka pomoću prekidača na dodir	Barvno temperaturo lahko nastavite v 3 korakih s stikalom na dotik	Цветовата температура може да се регулира на три стъпки с сензорен превключвател	Spalvos temperatūrą galima reguliuoti trimis žingsniais jutikliniu jungikliu	Krāsu temperatūru var regulēt trīs soļos ar skārienslēdzi	Värvitemperatuuri saab puuteliitiga kolmes astmes reguleerida
	Temperatura boje može se podesiti u 3 koraka pomoću CCT prekidača	Barvno temperaturo lahko nastavite v 3 korakih s CCT stikalom	Цветовата температура може да се регулира на 3 стъпки с CCT превключвател	Spalvos temperatūrą galima reguliuoti 3 žingsniais CCT jungikliu	Krāsu temperatūru var regulēt 3 soļos ar CCT slēdzi	Värvitemperatuuri saab CCT-lülitiga reguleerida 3 astmes
	LED s promjenjivim bojama	LED diode s spremenljivim barvama	LED с променлива светлина	Spalvą keičiantis LED	Maināmas krāsas LED	Värvi vahetav LED
	Prilagodljiva svjetlina s prekidačem u tri koraka	Prilagodljiva svetlost s stikalom v 3 korakih	Регулируема яркост с ключ на 3 степени	Ryškumas reguliuojamas su jungikliu 3 žingsniais	Trīs līmeņu regulējams spilgtums ar slēdzi	Lülitist 3-astmeliselt reguleeritav heledus

KEY OF SYMBOLS • JELMAGYARÁZAT • ZEICHENERKLÄRUNG



	Symbols	Jelölések	Bezeichnungen	Symboles	Jména	Označenia
	Adjustable brightness in 3 steps with touch switch	Érintőkapsolóval több lépésben szabályozható fényerő	Einstellbare Helligkeit mit Touch-Schalter in 3 Stufen	Luminosité ajustable avec interrupteur tactile à 3 positions	Nastavitelný jas s dotykovým spínačem ve 3 krocích	Nastaviteľný jas s dotykovým spínačom v 3 krokoch
	With switch	Kapsolóval	Mit Schalter	Avec commutateur	Se spínačem	So spínačom
	Remote control	Távírányítóval	Fernbedienung	Télécommande	Dálkové ovládání	Diaľkový ovládač
	Brightness adjustable with a switch	Kapsolóval állítható fényerő	Helligkeit per Schalter einstellbar	Luminosité réglable via interrupteur	Nastavitelná intenzita světla pomocí spínače	Nastaviteľná intenzita svetla pomocou vypínača
	Brightness adjustable by remote control	Távírányítóval állítható fényerő	Helligkeit per Fernbedienung einstellbar	Luminosité réglable par télécommande	Nastavitelná intenzita světla dálkovým ovládačem	Nastaviteľná intenzita svetla diaľkovým ovládačom
	Touch switch dimmer	Érintőkapsolóval szabályozható fényerő	Touchbutton-Lichtstärkeregler	Réglage de la luminosité avec interrupteur tactile	Nastavení jasu dotykovým spínačem	Dotykový spínač na regulácia intenzity svetla
	Dimmable	Szabályozható fényerő	Lichtstärke Regler	Regleur d'intensité de la lumière	Regulátor jasu	Regulátor jasu
	Motion sensor	Mozgásérzékelő	Bewegungssensor	Détecteur mouvement	Senzor pohybu	Senzor pohybu
	Microwave sensor	Mikrohullámú mozgásérzékelő	Mikrowellen-Sensor	Capteur à micro-ondes	Mikrovlnný snímač	Mikrovlnný snímač
	Illuminates upwards	Felfelé világít	Leuchtet nach oben	Éclaire vers le haut	Svítlí nahoru	Svietí nahor
	Illuminates downwards	Lefelé világít	Leuchtet nach unten	Éclaire vers le bas	Směr svícení dolů	Svieti smerom dole
	Illuminates downwards and upwards	Lefelé és felfelé is világít	Leuchtet nach oben und nach unten	Éclaire vers le bas et vers le haut	Směr svícení nahoru i dolů	Svieti smerom dole aj hore
	Environmentally friendly	Környezetbarát	Umweltschonend	Écologique	Je šetrný k životnímu prostředí	Šetrný k životnému prostrediu
	Light reactive, only illuminates in the dark	Fényérzékelő lámpa, csak sötétben világít	Mit Helligkeitssensor, leuchtet nur im Dunkeln	L'appareil est muni d'un photodétecteur, il ne se manifestera que s'il est plongé dans l'obscurité	Se světelným senzorem, svítí pouze ve tmě	So svetelným senzorem, svietí iba v tme
	UV resistant plastic	UV álló műanyag	UV-beständiger Kunststoff	Plastique résistant à l'UV	Plast odolný UV záření	Plast odolný UV žiareniu
	Lamp operating with solar cells	Napelemmel működő lámpa	Leuchte funktioniert über Solarzellen	Luminaire fonctionnant avec une cellule photovoltaïque	Svítidlo na solární baterii	Plast odolný UV
	IP protection	IP védettség	IP-Klasse	Protection IP	IP krytí	IP ochrana
	Indirect light	Indirekt fény	Mit indirektem Licht	À lumière indirecte	S nepřímým světlem	S nepriamym svetlom
	Backlight effect	Háttérfény funkció	Hintergrundlichteffekt	Effet de contre-jour	Efekt podsvícení	Efekt podsvietenia
	Adjustable sensor	Állítható érzékelő	Verstellbarer sensor	Capteur réglable	Nastavitelný senzor	Nastaviteľný senzor

KEY OF SYMBOLS • JELMAGYARÁZAT • ZEICHENERKLÄRUNG



	Oznaczenia	Позначення	Simboluri	Označavanje	Oznake
	Jasność dostosowywana dotykowo w 3 krokach	Регульована яскравість з сенсорним перемикачем в 3 кроки	Luminozitate ajustabilă prin atingere, în 3 trepte	Podesivo osvetljenje u 3 koraka uz pomoć prekidača koji se aktivira dodirom	Prilagodljiva svjetlina s dodirnim prekidačem u tri koraka
	Z włącznikiem	Із перемикачем	Cu întrerupător	Sa prekidačem	S prekidačem
	Pilot zdalnego sterowania	Дистанційне керування	Telecomandă	Dalečinski upravljač	Daljinski upravljač
	Regulacja jasności za pomocą przełącznika	Регулювання яскравості за допомогою вимикача	Intensitate luminoasă reglabilă cu ajutorul întrerupătorului	Podešavanje jačine svetla prekidačem	Podešavanje jačine svjetla prekidačem
	Regulacja jasności za pomocą pilota	Регулювання яскравості за допомогою пульта дистанційного керування	Intensitate luminoasă reglabilă cu telecomandă	Podešavanje jačine svetla daljinskim upravljačem	Podešavanje jačine svjetla daljinskim upravljačem
	Ściemniacz dotykowy	Сенсорний диммер	Senzor tactil pentru reglarea luminozității	Podešavanje jačine svetlosti sa prekidačem na dodir	Podešavanje svjetline pomoću dodirne sklopke
	Regulator natężenia światła	Регулятор потужності світла	Regulator intensitate lumina	Regulator svetlosti	Regulator jačie svjetla
	Czujnik ruchu	Датчик руху	Senzor de mișcare	Senzor kretanja	Senzor kretanja
	Mikrofalowy czujnik ruchu	Мікрохвильовий датчик	Senzor cu microunde	Mikrotalasni senzor	Mikrovalni senzor
	Świeci do góry	Світиться вгору	Iluminează în sus	Svetli prema gore	Osvjetljava prema gore
	Świeci w dół	Напря́м світла дони́зу	Luminează în jos	Nadole svetli	Svijetli nadolje
	Świeci w dół i w górę	Напря́м світла дони́зу і догори	Luminează în jos și în sus	Svetli i nagore i nadole	Svijetli i nadolje i nagore
	Przyjazny dla środowiska	Безпечний для довкілля	Ecologic	Ekološki prihvatljiv	Ekološki prihvatljiv
	Z czujnikiem oświetlenia, świeci tylko w ciemności	Оснащений сутінковим світловим вмикачем, включається тільки при зниженні інтенсивності освітлення	Cu sensor, luminează doar în întuneric	Osetljiv na svetlost, svetli samo u mraku	Osjetljiv na svjetlost, svijetli samo u mraku
	Tworzywo sztuczne odporne na UV	УФ-стійкий пластик	Material plastic rezistent la UV	UV otporna plastika	Plastika otporna na UV zrake
	Lampa zasilana energią słoneczną	Лампа на сонячній батареї	Lampă cu acumulator solar	Solarna lampa	Solarna svjetiljka
	Stopień ochrony IP	Клас IP-захисту	Protecția IP	IP zaštita	IP zaštita
	Ze światłem pośrednim	З непрямим освітленням	Cu lumină indirectă	Sa indirektnim svetlom	S neizravnim svjetlom
	Efekt podświetlenia	Ефект підсвічування	Efect iluminare de fundal	Pozadinsko osvetljenje	Efekt pozadinskog svjetla
	Regulowany czujnik	Регульований датчик	Senzor reglabil	Podesivi senzor	Podesivi senzor

KEY OF SYMBOLS • JELMAGYARÁZAT • ZEICHENERKLÄRUNG



new/új/neu	Oznake	Символи	Simboliai	Simboli	Sümbolid
	Prilagodljiva svetlost s stikalom na dotik v 3 korakih	Регулируема яркост с ключ с докосване на 3 степени	Ryškumas reguliuojamas su jutkliniu jungikliu 3 žingsniais	Trīs līmeņu regulējams spilgtums ar skārienjūtīgu slēdzi	Puutetülitist 3-astmeliselt reguleeritav heledus
	S stikalom	С превключвател	Su jungikliu	Ar slēdzi	Lūlitiga
	Daljinski upravljalnik	Дистанционно управление	Nuotolinio valdymo pultas	Tālvadības pults	Pult kaugjuhtimiseks
	Nastavljiva svetlost s stikalom	Регулиране на яркостта с превключвател	Ryškumas reguliuojamas jungikliu	Spilgtums regulējams ar slēdzi	Heledus reguleeritav lūlitiga
	Nastavljiva svetlost z daljinskim upravljalnikom	Регулиране на яркостта с дистанционно управление	Ryškumas reguliuojamas nuotolinio valdymo pultu	Spilgtums regulējams ar tālvadības pulti	Heledus reguleeritav puldīga
	Prilagodite svetlost z stikalom na dotik	Регулятор на яркостта със сензорен превключвател	Liečiamasis pritemdymo jutiklis	Skārienjūtīgs gaismmaiņa slēdzis	Puutetundlik valgusregulaator
	Zatemnilnik	С регулятор за силата на светлина	Pritemdymo įtaisas	Gaismmainis	Hāmardi
	Senzor gibanja	Със сензор за движение	Judesio jutiklis	Kustības sensors	Liikumisandur
	Mikrovalovni senzor	Микровълнов сензор	Mikrobangų jutiklis	Mikrovļņu sensors	Mikrolaineandur
	Sveti navzgor	Свети нагоре	Šviesa nukreipta į viršų	Iedegas uz augšu	Valgustab ülespoole
	Svetli navzdol	Осветява надолу	Šviečia žemyn	Apgaismo lejup	Valgustab allapoole
	Svetel in gor in dol	Осветява надолу и нагоре	Šviečia žemyn ir aukštyn	Apgaismo lejup un augšup	Valgustab alla- ja ülespoole
	Okolju prijazno	Щадящ околната среда	Draugiškas aplinkai	Videi draudzīgs	Keskkonnasõbralik
	Občutljivo na svetlobo, sveti le v temi	Реагира на светлина, светва само, когато е тъмно	Reaguoja į šviesą, užsidega tik tamsoje	Reaģējošs uz gaismu, apgaismo tikai tumsā	Valgusreaktiivne, valgustab vaid pimedas
	Plastika UV-odporen	Устойчива на UV лъчи пластмаса	UV atsparus plastikas	Pret UV stariem noturīga plastmasa	UV-kindel plastik
	Sončna svetilka	Лампа, работеща със слънчеви батерии	Veikia su saulės energijos skydeliu	Darbojas ar saules bateriju	Sisselūlitamine päikeseelemendiga
	IP zaščita	с IP защита	IP klasė	IP aizsardzība	IP kaitse
	S posredno svetlobo	С индиректна светлина	Su netiesiogine šviesa	Ar netiešu gaismu	Kaudvalgusega
	Učinek osvetlitve	Ефект на подсветка	Foninio apšvietimo efektas	Aizmugurapgaismojuma efekts	Tagantvalgustuse efekt
	Nastavljiv senzor	Регулируем сензор	Reguliuojamas jutiklis	Regulējams sensors	Reguleeritav andur

KEY OF SYMBOLS • JELMAGYARÁZAT • ZEICHENERKLÄRUNG



new/új/neu	Symbols	Jelölések	Bezeichnungen	Symboles	Jména
	Moveable heads	Mozgatható fej	Bewegliche Köpfe	Têtes mobiles	Pohyblivé hlavy
	Infrared remote	Infravörös távirányító	Infrarotfernbedienung	Télécommande infrarouge	Infračervené dálkové ovládání
	Plastic	Műanyag	Plastik (Kunststoff)	Plastique	Plast
	Timer function	Időzítő funkció	Mit einer Zeitfunktion	Avec fonction de temps	S časovačem
	Night light function	Éjszakai funkció	Nachtfunktion	Fonction nuit	Funkce nočního světla
	Memory function	Memória funkció	Speicherfunktion	Fonction mémoire	Funkce pamět
	Can be controlled via Bluetooth	Vezérlés Bluetooth kapcsolaton keresztül	Steuerung über Bluetooth	Commande via liaison Bluetooth	Ovládání prostřednictvím Bluetooth kontaktu
	Micro-USB included	Micro-USB tartozék	Micro-USB Zubehör	Avec Micro USB livré	Micro-USB v příslušenství
	Battery excluded	Elemet nem tartalmaz	Ohne Batterie	Pile non incluse	Baterie není součástí balení
	Battery included	Elemet tartalmaz	Inklusive Batterie	Pile incluse	Součástí balení je baterie
	IK08 strong diffusor	Búra mechanikus ütődés elleni védelem 08	Schlagfestigkeit IK08	Diffuseur puissant IK08	Odolnost proti nárazu IK08
	Equipped with SCHUKO Type F, CEE 7/4 power connector socket. Not available for CZ, SK and PL.	SCHUKO Type F, CEE 7/4 hálózati csatlakozó aljzattal. Nem rendelhető: CZ, SK és PL.	Mit SCHUKO Netzstecker Typ F, CEE 7/4. Nicht bestellbar in: CZ, SK und PL	SCHUKO Type F, avec douille CEE 7/4. Ne peut être commandé : CZ, SK et PL	SCHUKO Type F, CEE 7/4 se síťovou zásuvkou. Nelze objednat: CZ, SK a PL
	Cutttable	Vágható	Schneidbar	Découpable	Řezatelný
	Not suitable for cutting	Nem vágható	Nicht zerschneidbar	Ne peut pas être coupé	Nelze stříhat
	Number of LED diodes per metre	LED diódák száma méterenként	Anzahl der LED-Dioden pro Meter	Nombre de diodes DEL par mètre	Počet LED diod na metr
	2 in 1	Kettő az egyben	2 in 1	2 en 1	2 v 1
	Delivery unit	Szállítási egység	Liefereinheit	Unité de transport	Dodací jednotka
	Units/set	Darab/szett	Stück/set	Pièce / lot	Ks/sada

KEY OF SYMBOLS • JELMAGYARÁZAT • ZEICHENERKLÄRUNG



new/új/neu	Označenia	Oznaczenia	Позначення	Simboluri	Označavanje
	Pohyblivé hlavy	Ruchome głowy	Рухомі голови	Capete mobile	Покретне главе
	Infračervené diaľkové ovládanie	Pilot na podczerwień	Інфрачервоний пульт	Telecomandă cu infraroșu	Infracrveni daljinski
	Plast	Wykonane z plastiku	Пластик	Plastic	Plastika
	S časovačom	Z funkcją timera	З функцією таймера	Cu temporizator	Sa vremenskom funkcijom
	Funkcia nočného svetla	Funkcja światła nocnego	Функція нічника	Funcție lumina de noapte	Funkcija nočno svetlo
	Funkcia pamäte	Funkcja pamięci	Функція пам'яті	Funcție de memorie	Funkcija pamćenja
	Riadenie prostredníctvom Bluetooth pripojenia	Sterowanie przez połączenie Bluetooth	Керування через Bluetooth	Operare prin conexiune Bluetooth	Upravljanje preko Bluetooth veze
	Príslušenstvo Micro-USB	Micro-USB w zestawie	Містить мікро-USB	Accesoriu Micro-USB	Mikro-USB dodatna oprema
	Batéria nie je súčasťou balenia	Nie zawiera baterii	Батарея не додається	Bateria nu e inclusă	Bez baterije
	Súčasťou balenia je batéria	Bateria w zestawie	Батарея додається	Bateria este inclusă	Baterija u opremi
	Silný difúzor IK08	Ochrona przed uderzeniami mechanicznymi IK08	Захист від механічного пошкодження плафону IK08	Difuzor puternic IK08	IK08 čvrst difuzor
	SCHUKO Type F, CEE 7/4 so sieťovou zásuvkou. Nie je možné objednať: CZ, SK a PL	Z gniazdem zasilania SCHUKO Type F, CEE 7/4. Brak możliwości zamawiania: CZ, SK i PL	SCHUKO Type F, з гніздом живлення CEE 7/4. Неможливо замовляти: CZ, SK та PL	Cu soclu priză SCHUKO Type F, CEE 7/4. Nu poate fi comandat în CZ, SK și PL	Sa mrežnom priključnicom tipa SCHUKO Type F, CEE 7/4. Ne može da se naruči iz: CZ, SK i PL
	Strihateľný X cm	Do cięcia	Обрізний	Tăiat	Reziv
	Nemožno strihať	Cięcie nie jest możliwe	Не можна різати	Nu poate fi tăiat	Ne može se seći
	Počet LED diód na meter	Liczba diod LED na metr	Кількість світлодіодів на метр	Nr. de LED-uri pe metru	Broj LED dioda po metru
	3 v 1	2 w 1	2 в 1	2 în 1	2 u 1
	Dodacia jednotka	Jednostka logistyczna	Одиниця поставки	Unitate de livrare	Transportna jedinica
	Kus/sada	Sztuka/zestaw	Шт / комплект	Bucăți/set	Komad/set

KEY OF SYMBOLS • JELMAGYARÁZAT • ZEICHENERKLÄRUNG



new/új/neu	Oznake	Oznake	Символи	Simboliai	Simboli	Sümbolid
	Pokretni glave	Premične glave	Подвижни глави	Judamosios galvos	Pārvietojamas galvas	Liikuvad pead
	Infracrveni daljinski upravljač	Infrardeči daljinski upravljalnik	Инфрачервено дистанционно	Infraraudonųjų spindulių nuotolinio valdymo pultas	Infrasarkano staru tālvadības pults	Infrapuna kaugjuhtimispuht
	Plastika	Plastika	Пластмаса	Plastikinis	Plastmasa	Plastist
	S vremenskom funkcijom	S časovno funkcijo	С функция за време	Su laiko funkcija	Ar laika funkciju	Ajafunktsiooniga
	Funkcija nočnog svjetla	Nočna funkcija	Функция ношна светлина	Naktinio apšvietimo funkcija	Nakts apgaismojuma funkcija	Õine funktsioon
	Funkcija memorije	Pomnilna funkcija	Функция памет	Atminties funkcija	Atmiņas funkcija	Mālu funktsioon
	Upravljanje putem Bluetootha	Nadzor prek povezave Bluetooth	Управление чрез Bluetooth връзка	Galima valdyti naudojant Bluetooth	Var kontrolēt, izmantojot Bluetooth	Juhitav Bluetooth kaudu
	Mikro USB pribor	Mikro USB-pripomoček	С принадлежност Micro-USB	Priedama „Micro-USB“	Micro-USB iekļauts komplektā	Mikro-USB komplektis
	Baterija nije uključena	Baterije niso vključene	Не е предоставена батерия	Be baterijos	Baterija neietilpst komplektā	Patarei ei kuulu komplekti
	Baterija je uključena	Baterije so vključene	Предоставена батерия	Su baterija	Baterija ietilpst komplektā	Patarei kuulub komplekti
	Zaštita od mehaničkih utjecaja	IK08 močan difuzor	Устойчивост на удар IK08	Tvirtumo klasė IK08	IK08 spēcīgs difuzors	IK08 löögikindluse klassi hajuti
	S mrežnim priključkom tipa SCHUKO Type F, CEE 7/4 Nije moguće naručiti iz: CZ, SK i PL	Z vtičem tipa SCHUKO Type F, CEE 7/4 Ni mogoče naročiti pri: CZ, SK in PL	SCHUKO Type F, захранващо щепселно гнездо CEE 7/4. Не може да се заявява за: CZ, SK и PL	Įmontuotas SCHUKO F tipo CEE 7/4 maitinimo įvesties lizdas. Neprieinama CZ, SK ir PL	Aprīkots ar SCHUKO F tipa, CEE 7/4 strāvas ievades/izvades ligzdu. Nav pieejams CZ, SK un PL	SCHUKO Tüüp F, CEE 7/4 toite sisse/välja pistikuga. Mitte saadaval CZ, SK ja PL jaoks
	Režeći	Rezljiv	Режещ	Pjaustomas	Lõigatav	Lõigatud
	Ne može se rezati	Ni mogoče rezati	Не може да се реже	Netinka pjaustymui	Nav piemērots griešanai	Ei sobi lõikamiseks
	Broj LED dioda po metru	Število LED dioda na meter	Брой светодиоди на метър	Šviesos diodų skaičius viename metre	Diožu skaits uz metru	Valgusdiodide arv meetri kohta
	2 u 1	2 v 1	2 в 1	Du viename	Divi vienā	Kaks-ühes
	Transportna jedinica	Transportna enota	Транспортна единица	Pristatomas įrenginys	Piegādes vienība	Tarnesse kuulub
	Komad / set	Kos / set	Брой/сет	Vnt./Rinkinys	Gab./Komplektā	Tükki/komplekt

CONTENTS • TARTALOMJEGYZÉK • INHALTSVERZEICHNIS

New	Art. number	Name	Page
Új	Cikkszám	Név	Oldal
Neu	Art. number	Name	Seite

New	Art. number	Name	Page
Új	Cikkszám	Név	Oldal
Neu	Art. number	Name	Seite

New	Art. number	Name	Page
Új	Cikkszám	Név	Oldal
Neu	Art. number	Name	Seite

New	Art. number	Name	Page
Új	Cikkszám	Név	Oldal
Neu	Art. number	Name	Seite

New	Art. number	Name	Page
Új	Cikkszám	Név	Oldal
Neu	Art. number	Name	Seite

	2697	ZENON	115
	2698	ZENON	115
	3309	YAGO	143
	3437	LUCAS	114
new	71504	LUCAS 2	114
	3438	LUCAS	114
new	71505	LUCAS 2	114
	3439	LUCAS	114
new	71506	LUCAS 2	114
new	71510	LUCAS 2	114
new	71511	LUCAS 2	114
new	71512	LUCAS 2	114
	5810	LENTIL	125
	7040	ODERA	153
	7060	TURDA	167
	7070	ZATON	91
	7127	TAVERNA	46
	7128	TAVERNA	46
	7129	TAVERNA	46
	7130	TAVERNA	46
	7146	PARAVENTO	45
	7147	PARAVENTO	45
	7149	PARAVENTO	45
	7150	PARAVENTO	45
	7158	TEPLICE	41
	7159	TEPLICE	41
	7236	NOVIGRAD	90
	7237	NOVIGRAD	90
	7238	DUBROVNIK	47
	7239	DUBROVNIK	47
	7240	DUBROVNIK	47
	7244	ORLOVA	93
	7250	PERNIK	103
	7265	PERNIK	103
	7317	LIPPA	69
	7318	LIPPA	69
	7319	LIPPA	69
	7320	LIPPA	69
	7379	ANKARA	39
	7380	ANKARA	39
	7386	KOLTA	89
	7396	SOLIN	68
	7397	SOLIN	68
	7406	HORT	125
	7407	HORT	125
	7408	HORT	125
	7409	HORT	125
	7476	BALIMO	77
	7477	BALIMO	77
	7478	BALIMO	77
	7479	BALIMO	77
	7502	WELLINGTON	89
	7504	PALANGA	32
	7505	PALANGA	32
	7506	PALANGA	32
	7774	INVERNESS	101
	7775	INVERNESS	101
	7797	OPOLE	74
	7814	KROBIA	167
	7817	ZOMBOR	94
	7818	ZOMBOR	94
	7819	ZOMBOR	94
	7820	ZOMBOR	94
	7826	LISBON	52
	7827	LISBON	52
	7828	LISBON	52
	7829	LISBON	52
	7836	MADRID	140

	7837	MILANO	134
	7850	YOLA	164
	7877	FUNGHETTO	168
	7880	OSTRAVA	159
	7881	OSTRAVA	159
	7884	ALMADA	44
	7885	ALMADA	44
	7887	BUFFALO	85
	7888	BUFFALO	85
	7891	SILISTRA	90
	7892	SILISTRA	90
	7893	TARTU	104
	7894	TARTU	104
	7895	TARTU	104
	7896	TARTU	104
	7897	TARTU	104
	7898	TARTU	104
	7899	TARTU	104
	7900	TARTU	104
	7904	BELFAST	37
	7929	ELVA	37
	7930	ELVA	37
	7935	HALDEN	80
	7951	NESNA	72
	7952	NESNA	72
	7955	SINTRA	85
	7956	SINTRA	85
	7959	MANDAL	88
	7960	MANDAL	88
	7969	AMARILLO	126
	7970	OPAVA	159
	7975	DANNET	165
	7979	ERIC	115
	7980	AMARILLO	126
	8011	PUEBLO	127
	8018	CHILE	87
	8019	CHILE	87
	8029	CHILE	87
	8030	CHILE	87
	8118	PHOENIX	88
	8119	PHOENIX	88
	8130	NAVIA	63
	8134	VARNA	80
	8135	VARNA	80
	8145	BLACKTORCH	48
	8146	BLACKTORCH	48
	8147	BLACKTORCH	48
	8148	BLACKTORCH	48
	8149	AKRON	95
	8150	AKRON	95
	8154	FOLLINA	63
	8163	ODESSA	139
	8164	ODESSA	139
	8165	ODESSA	139
	8181	MONACO	130
	8182	MONACO	130
	8184	MONACO	130
	8185	MONACO	130
	8186	MONACO	130
	8190	DARIUS	146
	8201	VELENCE	136
	8202	VELENCE	136
	8203	VELENCE	136
	8204	VELENCE	136
	8205	VELENCE	136
	8206	VELENCE	136
	8207	VELENCE	136
	8208	VELENCE	136

	8209	VELENCE	136
	8210	VELENCE	135
	8216	VELENCE	136
	8217	VELENCE	135
	8218	VELENCE	137
	8232	VELENCE	137
	8234	VELENCE	137
	8236	VELENCE	137
	8238	VELENCE	137
	8240	VELENCE	137
	8244	HAGA	147
	8261	INOXTORCH	50
	8263	INOXTORCH	50
	8264	INOXTORCH	50
	8265	INOXTORCH	51
	8266	INOXTORCH	51
	8267	INOXTORCH	51
	8270	OSLO	143
	8271	OSLO	142
	8337	BONN	49
	8338	BONN	49
	8339	BONN	49
	8341	MILANO	134
	8342	MILANO	134
	8344	MILANO	134
	8345	MILANO	134
	8346	MILANO	134
	8365	SOLAR1	169
	8366	SOLAR1	169
	8370	MILANO	132
	8371	MILANO	132
	8372	MILANO	132
	8373	MILANO	133
	8374	MILANO	133
	8375	MILANO	133
	8376	MILANO	132
	8377	MADRID	140
	8379	MADRID	141
	8381	TORONTO	131
	8391	TOSCANA	138
	8392	TOSCANA	138
	8394	TOSCANA	138
	8395	TOSCANA	138
	8409	ROMA	92
	8410	ROMA	92
	8460	TORONTO	131
	8476	MADRID	140
	8480	MADRID	141
	8496	HEKTOR	146
	8499	HEKTOR	146
	8511	ROMA	92
	8680	OSLO	144
	8681	OSLO	142
	8682	OSLO	144
	8683	STUTTGART	117
	8684	STUTTGART	117
	8685	STUTTGART	117
	8686	VIGO	145
	8687	VIGO	145
	8714	TACOMA	127
	8716	OSLO	144
	8717	OSLO	144
	8736	OSLO	142
	8737	OSLO	142
	8739	OSLO	142
	8740	OSLO	142
	8753	NORVICH	147

	8754	NORVICH	147
	8763	OSLO	143
	8764	OSLO	143
	8766	DURANGO	93
	8767	DURANGO	93
	8776	ROMA	92
	8795	BIRMINGHAM	75
	8799	SEVILLA	93
	8800	SEVILLA	93
	8832	MEDINA	86
	8833	MEDINA	86
	8834	MEDINA	86
	8835	MEDINA	86
	8873	MARIBOR	70
	8874	MARIBOR	70
	8888	BUDAPEST	43
	8889	BUDAPEST	43
	8890	BUDAPEST	43
	8893	TRENTO	126
	8894	TRENTO	126
	8940	RODEZ	75
	8948	MORA	166
	8949	MORA	166
	71132	LUCAS	121
	71133	LUCAS	121
	71134	LUCAS	121
	71252	SAMIRA	110
	71253	SAMIRA	110
	71254	SAMIRA	110
	71255	SAMIRA	111
	71256	SAMIRA	111
	71257	SAMIRA	110
	71258	SAMIRA	110
	71259	SAMIRA	110
	71260	SAMIRA	111
	71261	SAMIRA	111
	71342	KOVEN	95
	71343	KOVEN	95
	71422	ALENZO	107
	71423	ALENZO	107
	71424	ALENZO	108
	71425	ALENZO	106
	71426	ALENZO	106
	71427	ALENZO	106
	71428	ALENZO	108
	71429	ALENZO	106
	71430	ALENZO	108
	71431	ALENZO	101
	71432	ALENZO	107
	71433	ALENZO	107
	71434	ALENZO	108
	71435	ALENZO	106
	71436	ALENZO	106
	71437	ALENZO	106
	71438	ALENZO	108
	71439	ALENZO	106
	71440	ALENZO	108
	71441	ALENZO	101
	75009	LARCIA	116
	75010	LARCIA	116
	75011	LARCIA	121
	75012	LARCIA	121
	75025	GAELO	115
	75026	GAELO	115
new	75065	Dolen	97
new	75066	Dolen	97
new	75067	Dolen	96
new	75068	Dolen	96

new	75069	Modane	56
new	75070	Modane	56
new	75071	Shaun Plus	118
new	75072	Shaun Plus	118
new	75073	Shaun Plus	118
new	75074	Shaun Plus	118
new	75075	Shaun Plus	118
new	75076	Shaun Plus	118
new	75077	Shaun Plus	118
new	75078	Shaun Plus	118
new	75079	Shaun Plus	118
new	75080	Maurec	98
new	75081	Maurec	98
new	75082	Maurec	98
new	75083	Lautrec	99
new	75084	Lautrec	99
new	75085	Lautrec	99
	76036	MIREO	151
	76037	MIREO	151
	76038	MIREO	151
	76039	MIREO	151
	77001	WIGRY	171
	77002	BOBUS	171
	77004	NARMADA	156
	77005	QESA	156
	77006	BREZNO	157
	77011	KELNA	167
	77012	ZLARIN	163
	77013	SEPIK	157
	77014	MOSELLE	156
	77015	KAPUAS	157
	77016	ANSOO	172
	77017	ALASKA	155
	77018	ALASKA	155
	77019	VALPOVO	163
	77020	LIHULL	162
	77024	KANGTON	156
	77025	ANKARA	39
	77026	ANKARA	39
	77028	HITURA	124
	77029	HITURA	124
	77030	LUTTO	157
	77035	INDRE	102
	77036	INDRE	102
	77040	FLAXTON	161
	77042	RENNES	75
new	77043	Tavira	170
	77046	SLUIS	164
	77049	TILBURG	62
	77050	TILBURG	62
new	77052	Zilina	59
new	77053	Zilina	59
	77054	CERNON	29
	77055	CERNON	29
	77056	CERNON	29
	77057	ODIEL	30
	77058	ODIEL	30
	77059	ODIEL	30
	77060	ODIEL	30
new	77063	Kioni	60
	77064	SENICA	81
	77065	TEMSE	63

CONTENTS • TARTALOMJEGYZÉK • INHALTSVERZEICHNIS

New	Art. number	Name	Page
Új	Cikkszám	Név	Oldal
Neu	Art. nummer	Name	Seite

	77074	MATARO	71
	77075	MATARO	71
	77076	MATARO	71
new	77077	Pemba	61
	77078	LASSET	155
	77079	LASSET	155
	77080	LOANDA	40
	77081	LOANDA	40
	77082	LOANDA	40
	77085	ZERNEST	91
	77086	ZERNEST	91
	77088	NANTES	167
	77090	FLAXTON	161
	77092	ZARAGOZA	78
	77093	ZARAGOZA	78
	77095	ANDELLE	76
	77096	ANDELLE	76
	77097	GIMONE	76
	77098	GIMONE	76
	77099	LUBLIN	74
	77100	LUBLIN	74
	77101	TELDE	28
	77102	TELDE	28
	77103	MEDNA	28
	77104	MEDNA	28
	77105	TRENTO	126

New	Art. number	Name	Page
Új	Cikkszám	Név	Oldal
Neu	Art. nummer	Name	Seite

	77106	TARPA	42
	77107	TARPA	42
	77108	TARPA	42
	77109	IBAR	73
	77110	ENOL	36
	77111	ENOL	36
	77112	ENOL	36
	77113	ENOL	36
	77114	MATARO	73
	77115	ZARAGOZA	78
	77116	ZARAGOZA	78
	77117	BATIDA	79
	77118	BATIDA	79
	77119	BATIDA	79
	77120	BATIDA	79
	77121	LAXA	81
	77122	ANKARA	39
	77123	BIRI	172
	77124	BIRI	172
	77125	KELEBIA	58
	77126	DARVAS	34
	77127	DARVAS	34
	77128	DARVAS	34
	77129	ZAVOD	163
	77130	LEITHA	35
	77131	LEITHA	35

New	Art. number	Name	Page
Új	Cikkszám	Név	Oldal
Neu	Art. nummer	Name	Seite

	77132	LEITHA	35
	77133	LOWAR	112
	77134	LOWAR	112
	77135	LOWAR	112
	77136	LOWAR	112
	77137	LOWAR	122
	77138	LOWAR	122
	77139	LOWAR	122
	77140	LOWAR	122
	77141	MELK	163
	77142	BURDUR	153
	77143	FUNES	152
	77144	FUNES	152
	77145	FUNES	152
	77146	POLPERRO	150
	77147	POLPERRO	150
	77148	WENGEN	31
	77149	WENGEN	31
	77150	RAPLA2	81
	77151	RUST	64
	77152	RUST	64
	77153	RUST	64
	77154	URFA	82
	77155	URFA	82
	77156	URFA	82
	77157	URFA	82

New	Art. number	Name	Page
Új	Cikkszám	Név	Oldal
Neu	Art. nummer	Name	Seite

	77158	RAVELLO	168
	77159	TARCAL	160
	77160	TARCAL	160
	77161	URFA	83
	77162	URFA	83
	77163	URFA	83
	77164	URFA	83
	77165	ZIRC	170
new	77166	Ispra	158
	77167	SAVOCA	164
	77168	HALLSTATT	67
	77169	HALLSTATT	67
	77170	HALLSTATT	67
	77171	TOLNA	33
	77172	TOLNA	33
	77173	TOLNA	33
	77174	KOBARID	73
	77175	TRILLO	165
	77176	TAPOLCA	164
	77177	MONOR	169
new	77178	Gerla	65
new	77179	Gerla	65
new	77180	Gerla	65
	77181	LOWAR	112
	77182	LOWAR	112
	77183	CUBBINGTON	27

New	Art. number	Name	Page
Új	Cikkszám	Név	Oldal
Neu	Art. nummer	Name	Seite

	77184	CUBBINGTON	27
	77185	CUBBINGTON	27
	77186	CONG	168
	77187	BOKOD	165
	77188	HOLNE	165
new	77189	Kavala	127
new	77190	Kavala	127
new	77191	Portel	68
new	77192	Portel	68
new	77193	Gordes	37
new	77203	Lermos	156
new	77205	Montoro	158
new	77206	Tamarite	26
new	77207	Tamarite	26
new	77209	Urfa Line	84
new	77210	Urfa Line	84
new	77211	Urfa Line	84
new	77212	Urfa Line	84
new	77213	Lonato	124
new	77214	Lonato	124
	79021	LED STRIP	173
	79022	LED STRIP	173
	79023	LED STRIP	173

New	Name	Page
Új	Név	Oldal
Neu	Name	Seite

	AKRON	95
	ALASKA	155
	ALENZO	101, 106, 107, 108
	ALMADA	44
	AMARILLO	126
	ANDELLE	76
	ANKARA	39
	ANSOO	172
	BALIMO	77
	BATIDA	79
	BELFAST	37
	BIRI	172
	BIRMINGHAM	75
	BLACKTORCH	48
	BOBUS	171
	BOKOD	165
	BONN	49
new	Bradú	66
	BREZNO	157
	BUDAPEST	43
	BUFFALO	85
	BURDUR	153
	CERNON	29
	CHILE	87
	CONG	168
	CUBBINGTON	27
	DANNET	165
	DARIUS	146
	DARVAS	34
new	Dolen	96, 97
	DUBROVNIK	47
	DURANGO	93
	ELVA	37
	ENOL	36
	ERIC	115
	FLAXTON	161

New	Name	Page
Új	Név	Oldal
Neu	Name	Seite

	FOLLINA	63
	FUNES	152
	FUNGHETTO	168
	GAELO	115
new	Gerla	65
	GIMONE	76
new	Gordes	37
	HAGA	147
	HALDEN	80
	HALLSTATT	67
	HEKTOR	146
	HITURA	124
	HOLNE	165
	HORT	125
	IBAR	73
	INDRE	102
	INOXTORCH	50, 51
	INVERNESS	101
new	Ispra	158
	KANGTON	156
	KAPUAS	157
new	Kavala	127
	KELEBIA	58
	KELNA	167
new	Kioni	60
	KOBARID	73
	KOLTA	89
	KOVEN	95
	KROBIA	167
	LARCIA	116, 121
	LASSET	155
new	Lautrec	99
	LAXA	81
	LED STRIP	173
	LEITHA	35
	LENTIL	125

New	Name	Page
Új	Név	Oldal
Neu	Name	Seite

new	Lermos	156
	LIHULL	162
	LIPPA	69
	LISBON	52
	LOANDA	40
new	Lonato	124
	LOWAR	112, 122
	LUBLIN	74
	LUCAS	114, 121
	LUCAS 2	114
	LUTTO	157
	MADRID	140, 141
	MANDAL	88
	MARIBOR	70
	MATARO	71, 73
new	Maurec	98
	MEDINA	86
	MEDNA	28
	MELK	163
	MILANO	132, 133, 134
	MIREO	151
new	Modane	56
	MONACO	130
	MONOR	169
new	Montoro	158
	MORA	166
	MOSELLE	156
	NANTES	167
	NARMADA	156
	NAVIA	63
	NESNA	72
	NORVICH	147
	NOVIGRAD	90
	ODERA	153
	ODESSA	139
	ODIEL	30

New	Name	Page
Új	Név	Oldal
Neu	Name	Seite

	OPAVA	159
	OPOLE	74
	ORLOVA	93
	OSLO	142, 143, 144
	OSTRAVA	159
	PALANGA	32
	PARAVENTO	45
new	Pemba	61
	PERNIK	103
	PHOENIX	88
	POLPERRO	150
new	Portel	68
	PUEBLO	127
	QESA	156
	RAPLA2	81
	RAVELLO	168
	RENNES	75
	RODEZ	75
	ROMA	92
	RUST	64
	SAMIRA	110, 111
	SAVOCA	164
	SENICA	81
	SEPIK	157
	SEVILLA	93
new	Shaun Plus	118
	SILISTRA	90
	SINTRA	85
	SLUIS	164
	SOLAR1	169
	SOLIN	68
new	STUTTGART	117
	TACOMA	127
new	Tamarite	26
	TAPOLCA	164
	TARCAL	160

New	Name	Page
Új	Név	Oldal
Neu	Name	Seite

	TARPA	42
	TARTU	104
	TAVERNA	46
new	Tavira	170
	TELDE	28
	TEMSE	63
	TEPLICE	41
	TILBURG	62
	TOLNA	33
new	Tornio	38
	TORONTO	131
	TOSCANA	138
	TRENTO	126
	TRILLO	165
	TURDA	167
	URFA	82, 83
new	Urfa Line	84
	VALPOVO	163
	VARNA	80
	VELENCE	135, 136, 137
	VIGO	145
	WELLINGTON	89
	WENGEN	31
	WIGRY	171
	YAGO	143
	YOLA	164
	ZARAGOZA	78
	ZATON	91
	ZAVOD	163
	ZENON	115
new	Zilina	59
	ZIRC	170
	ZLARIN	163
	ZOMBOR	94

IMPRINT • IMPRESSZUM • IMPRESSUM

English

Colour and pattern discrepancy are possible. We are entitled to change the pattern.
We don't bear the responsibility of the printing failure.

Magyar

Szín és minta eltérés lehetséges. A minta változtatás jogát fenntartjuk!
Az esetleges nyomdai hibákért elnézésüket kérjük és azokért felelősséget nem vállalunk.

Deutsch

Farbe und Musterunterschied ist möglich. Wir halten das Recht von Musteränderung aufrecht.
Vor die eventuellen Druckfehler bitten wir um Entschuldigung und vor die Fehler können wir die Verantwortung nicht übernehmen.

Français

Il est bien possible d'avoir quelques alternances de la coloration et du modèle. Nous soutenons notre droit aux changements de modèles.
Excusez-nous des éventuelles fautes d'imprimerie dont nous ne nous considérons pas être les responsables.

Česky

Prodejce si vyhrazuje právo průběžně modifikovat své výrobky a tedy údaje uvedené v tomto katalogu mohou být bez předchozího oznámení změněny.
Tiskové chyby vyhrazeny.

Slovensko

Obstaja možnost odstopanja pri odenku barve izdelka. Pridržujemo si pravico do spremembe vzorca.
Ne prevzemamo odgovornosti za morebitne tiskarske napake.

Polski

Możliwe są odchylenia w kolorach i wzorach. Podtrzymujemy prawo zachowania zmiany wzoru.
Przepraszamy, a zarazem nie ponosimy odpowiedzialności za ewentualne błędy powstałe w druku.

Українська

Можлив зм ни у вз рцях та кольорах. Ми можемо зм нити вз рц на св й розсуд.
За можлив друкарськ помилки просимо вибачення та в дпов дальност не несемо.

Română

Este posibilă alternanța model/culoare. Ne reținem dreptul de a schimba modelele.
Pentru eventualele greseli de tipar, Vă cerem scuze ;dar nu ne asumăm răspunderea pentru ele.

Srpski

Moguće su razlike u bojama i šarama. Zadržavamo pravo na promene šara.
Za moguće štamparske greške unapred se izvinjavamo i za njih ne primamo na sebe odgovornost.

Hrvatski

Postoji mogućnost odstupanja u nijansi boje artikla.
Ne snosimo odgovornost u slučaju pogreške u tisku.

Slovensky

Predávajúci si vyhradzuje právo priebežne modifikovať svoje výrobky a preto aj údaje uvedené v tomto katalógu,
môžu byť zmenené bez predchádzajúceho oznámenia.
Za prípadné tlačové chyby nenesieme zodpovednosť.

български

Възможни са промени в цветовете и нюансите.
Ние не носим отговорност за печатни грешки.

Lietuvių

Galimi spalvų ir rašto netikslumai. Pasiliegame teisę keisti raštą.
Atsiprašome, bet už spausdinimo klaidas neprisiimame atsakomybės.

Latviešu

Ir iespējamas krāsas un modeļa neatbilstības. Mēs paturam tiesības mainīt modeli.
Atvainojamies, tomēr neuzņemamies atbildību par drukas kļūdām.

Eesti

Värv ja muster võib erineda. Jätame endale õiguse mustri muutmiseks.
Vabandame, kuid ei vastuta trükkivigade eest.

Grafikai munkák: Visionext Reklámstúdió
Nyomdai munkák: Keskeny és Társai 2001 Kft.



OUTDOOR LIGHTS OUTDOOR LIGHTS

**OUTDOOR
LIGHTS**

2026

www.rabalux.com